

Panasonic[®]



Administrator Guide

SIP Phone

Model No. **KX-HDV430**

Thank you for purchasing this Panasonic product.
Please read this manual carefully before using this product and save this manual for future use.

In this manual, the suffix of each model number is omitted unless necessary.

Introduction

Outline

This Administrator Guide provides detailed information on the configuration and management of this unit.

Audience

This Administrator Guide contains explanations about the installation, maintenance, and management of the unit and is aimed at network administrators and phone system dealers.

Technical descriptions are included in this guide. Prior knowledge of networking and VoIP (Voice over Internet Protocol) is required.

Related Documentation

Quick Start Guide

Briefly describes basic information about the installation of the unit.

Operating Instructions

Describes information about the installation and operation of the unit.

Manuals and supporting information are provided on the Panasonic Web site at:
<http://www.panasonic.net/pcc/support/sipphone/>

Technical Support

When technical support is required, contact your phone system dealer/service provider.

Trademarks

- Microsoft, Excel, Internet Explorer, Outlook, and Windows are either registered trademarks or trademarks of Microsoft Corporation in the United States and/or other countries.
- Firefox is a registered trademark of the Mozilla Foundation.
- Google Chrome is a registered trademark of Google Inc.
- All other trademarks identified herein are the property of their respective owners.
- Microsoft product screen shot(s) reprinted with permission from Microsoft Corporation.

NOTES

- The screen shots shown in this guide are provided for reference only, and may differ from the screens displayed on your PC.

Table of Contents

1	Initial Setup	9
1.1	Setup	10
1.1.1	Factory Defaults	10
1.1.2	Language Selection for the Unit	10
1.1.3	Basic Network Setup	10
1.1.4	Overview of Programming	13
1.1.5	Phone User Interface Programming	14
1.1.5.1	Changing the Language for Phone User Interface Programming	14
1.1.6	Web User Interface Programming	14
1.1.6.1	Password for Web User Interface Programming	15
1.1.6.2	Changing the Language for Web User Interface Programming	15
1.1.6.3	Before Accessing the Web User Interface	16
1.1.6.4	Accessing the Web User Interface	18
1.2	Firmware Update	21
1.2.1	Firmware Update	21
2	General Information on Provisioning	23
2.1	Pre-provisioning	24
2.1.1	What is Pre-provisioning?	24
2.1.2	How to Obtain a Pre-provisioning Server Address	24
2.1.3	Server Address Formats	24
2.1.4	Obtaining a Provisioning Server Address via SIP PnP	25
2.1.5	Obtaining a Provisioning Server Address from DHCP Options	26
2.2	Provisioning	30
2.2.1	What is Provisioning?	30
2.2.2	Protocols for Provisioning	30
2.2.3	Configuration File	30
2.2.4	Downloading Configuration Files	31
2.2.5	Provisioning Server Setting Example	36
2.2.6	Encryption	37
2.3	Priority of Setting Methods	38
2.4	Configuration File Specifications	39
2.5	Configuration File Examples	41
2.5.1	Examples of Codec Settings	41
2.5.2	Example with Incorrect Descriptions	42
3	Phone User Interface Programming	43
3.1	Phone User Interface Programming	44
3.1.1	Opening/Closing the Web Port	44
4	Web User Interface Programming	45
4.1	Web User Interface Setting List	46
4.2	Status	57
4.2.1	Version Information	57
4.2.1.1	Version Information	58
4.2.2	Network Status	58
4.2.2.1	Network Common	59
4.2.2.2	IPv4	59
4.2.2.3	IPv6	60
4.2.2.4	VLAN	61
4.2.3	VoIP Status	62
4.2.3.1	VoIP Status	62

4.3	Network	63
4.3.1	Basic Network Settings	63
4.3.1.1	IP Addressing Mode	64
4.3.1.2	IPv4	64
4.3.1.3	IPv6	66
4.3.2	Ethernet Port Settings	67
4.3.2.1	Link Speed/Duplex Mode	68
4.3.2.2	LLDP	69
4.3.2.3	VLAN	70
4.3.3	HTTP Client Settings	71
4.3.3.1	HTTP Client	71
4.3.3.2	Proxy Server	72
4.3.4	STUN Settings	73
4.3.4.1	STUN	73
4.3.5	Multicast Paging Settings	74
4.3.5.1	Multicast Paging	74
4.3.6	LDAP Settings	75
4.3.6.1	LDAP	76
4.3.7	Xtended Service Settings	78
4.3.7.1	Xtended Service	78
4.3.7.2	Xtended Service Settings [Line 1]–[Line 16]	79
4.3.8	UC Settings	81
4.3.8.1	Presence Feature	81
4.3.9	XML Application Settings	82
4.3.9.1	XML Application	83
4.3.9.2	XML Phonebook	85
4.3.10	ACD Settings [Line1]–[Line16]	86
4.3.11	Call Center Settings [Line1]–[Line16]	87
4.4	System	88
4.4.1	Language Settings	89
4.4.1.1	Selectable Language	89
4.4.1.2	Language Settings	91
4.4.2	User Password Settings	92
4.4.2.1	User Password	92
4.4.3	Admin Password Settings	93
4.4.3.1	Admin Password	93
4.4.4	Time Adjust Settings	94
4.4.4.1	Synchronization (Synchronisation)	94
4.4.4.2	Time Zone	95
4.4.4.3	Daylight Saving Time (Summer Time)	95
4.4.4.4	Start Day and Time of DST (Start Day and Time of Summer Time)	95
4.4.4.5	End Day and Time of DST (End Day and Time of Summer Time)	97
4.4.5	Advanced Settings	98
4.4.5.1	IP Phone	98
4.4.6	Import Display File	99
4.4.6.1	Import Display File	99
4.4.7	Wait Time	99
4.4.7.1	Wait Time	100
4.4.8	Communication Camera	100
4.4.8.1	Communication Camera Settings [No. 1]–[No. 16]	101
4.5	VoIP	101
4.5.1	SIP Settings	101
4.5.1.1	User Agent	102
4.5.1.2	NAT Identity	102
4.5.2	SIP Settings [Line 1]–[Line 16]	103

4.5.2.1	Basic	103
4.5.2.2	Advanced	105
4.5.3	VoIP Settings	110
4.5.3.1	RTP	111
4.5.3.2	Voice Quality Report	111
4.5.4	VoIP Settings [Line 1]–[Line 16]	113
4.5.4.1	Basic	114
4.5.4.2	Advanced	116
4.6	Telephone	118
4.6.1	Call Control	118
4.6.1.1	Call Control	118
4.6.1.2	Emergency Call Phone Numbers	121
4.6.1.3	Call Rejection Phone Numbers	121
4.6.2	Call Control [Line 1]–[Line 16]	122
4.6.2.1	Call Features	122
4.6.2.2	Dial Plan	126
4.6.3	Hotline Settings	127
4.6.3.1	Hotline	127
4.6.4	Flexible Key Settings (No. 1–24)	128
4.6.4.1	Flexible Key Settings	129
4.6.5	Tone Settings	130
4.6.5.1	Dial Tone	131
4.6.5.2	Busy Tone	132
4.6.5.3	Ringing Tone	133
4.6.5.4	Stutter Tone	133
4.6.5.5	Reorder Tone	134
4.6.6	Import Phonebook	135
4.6.6.1	Import Phonebook	136
4.6.7	Export Phonebook	136
4.6.7.1	Export Phonebook	137
4.6.8	Video Call Settings	137
4.6.8.1	Default Call Mode	138
4.6.8.2	Screen Mode	139
4.6.8.3	Send Image	139
4.6.8.4	Rate Settings	139
4.6.9	DSS Console	140
4.6.9.1	DSS 1-5 Key (No. 1–200)	141
4.7	Maintenance	142
4.7.1	Provisioning Maintenance	143
4.7.1.1	Provisioning Maintenance	143
4.7.2	Firmware Maintenance	145
4.7.2.1	Firmware Maintenance	145
4.7.3	Export Logging File	146
4.7.3.1	Export Logging File	146
4.7.4	Reset to Defaults	147
4.7.5	Restart	147
5	Configuration File Programming	149
5.1	Configuration File Parameter List	150
5.2	General Information on the Configuration Files	168
5.2.1	Configuration File Parameters	168
5.2.2	Characters Available for String Values	169
5.3	System Settings	170
5.3.1	System Settings	170
5.3.2	Basic Network Settings	172

5.3.3	Ethernet Port Settings	176
5.3.4	Pre-Provisioning Settings	179
5.3.5	Provisioning Settings	180
5.3.6	Firmware Update Settings	185
5.3.7	HTTP Settings	187
5.3.8	HTTPD/WEB Settings	189
5.3.9	TR-069 Settings	191
5.3.10	XML Settings	195
5.3.11	XSI Settings	200
5.3.12	XMPP (UC-ONE) Settings	205
5.3.13	LDAP Settings	207
5.3.14	Call Center Settings	211
5.3.15	SNMP Settings	214
5.3.16	Multicast Paging Settings	215
5.3.17	NTP Settings	218
5.3.18	Time Settings	218
5.3.19	Network Phonebook (Common)	224
5.3.20	Language Settings	224
5.3.21	NAT Settings	226
5.3.22	SIP Settings	228
5.3.23	SIP-TLS Settings	251
5.3.24	CODEC Settings	253
5.3.25	DTMF Settings	254
5.3.26	RTP/RTCP/RTCP-XR Settings	256
5.3.27	SRTP Settings	259
5.3.28	VQ Report by PUBLISH	261
5.3.29	uaCSTA Settings	263
5.3.30	Telephone Settings	265
5.3.31	Flexible Key Settings	271
5.3.32	DSS Key Settings	273
5.3.33	Tone Settings	274
5.3.34	Call Control Settings	284
5.3.35	Video Communication Settings	294
5.3.36	Network Camera Settings	296
5.3.37	Communication Camera Settings	299
5.3.38	Logging Settings	302
6	Useful Telephone Functions	305
6.1	Phonebook Import and Export	306
6.1.1	Import/Export Operation	308
6.1.2	Editing with Microsoft Excel	309
6.1.3	Exporting Data from Microsoft Outlook	311
6.2	Dial Plan	312
6.2.1	Dial Plan Settings	312
6.3	Flexible Keys	315
6.3.1	Settings using Web User Interface Programming	318
6.3.2	Settings using Configuration File Programming	319
6.4	Broadsoft XSI (Xtended Services Interface)	321
6.4.1	Outline	321
6.4.2	XSI Service Settings	322
6.5	BroadCloud (Presence)	323
6.5.1	Outline	323
6.5.2	BroadCloud (Presence) Function Settings	324
7	Firmware Update	325

7.1	Firmware Server Setup	326
7.2	Firmware Update Settings	326
7.3	Executing Firmware Update	326
8	Troubleshooting	329
8.1	Troubleshooting	330

Section 1

Initial Setup

This section provides an overview of the setup procedures for the unit.

1.1 Setup

1.1.1 Factory Defaults

Many of the settings for this unit have been configured before the unit ships.

Where possible, these settings are configured with the optimum or most common values for the setting. For example, the port number of the SIP (Session Initiation Protocol) server is set to "5060".

However, many of the settings, such as the address of the SIP server or the phone number, have not been pre-configured, and they must be modified depending on the usage environment. If the port number of the SIP server is not "5060", the value of this setting must be changed.

This unit thus will not function properly using only the factory default settings. The settings for each feature must be configured according to the environment in which the unit is used.

Note

- If you are using a PoE hub, the number of devices that you can connect simultaneously is limited by the amount of power supplied by the hub.

1.1.2 Language Selection for the Unit

You can change the language used on the LCD.

In addition, various settings can be configured by accessing the Web user interface from a PC on the same network (→ see **4 Web User Interface Programming**). You can select the language for the Web user interface.

Note

- To select the display language for the unit, refer to the Operating Instructions on the Panasonic Web site (→ see **Introduction**).
- To select the display language for the Web user interface, see **4.4.1 Language Settings**.

1.1.3 Basic Network Setup

This section describes the basic network settings that you must configure before you can use the unit on your network.

You must configure the following network settings:

- IP Address Mode (IPv4 or IPv6 or IPv4/IPv6 Dual) settings
- TCP/IP settings (DHCP / RA for IPv6 / static IP)
- DNS server settings

For details about basic network settings via the Web user interface, see **4.3.1 Basic Network Settings**.

TCP/IP Settings for IPv4 (DHCP or Static IP Address Assignment)

A unique IP address must be assigned to the unit so that it can communicate on the network. How you assign an IP address depends on your network environment. This unit supports the following 2 methods for assigning an IP address:

Obtaining an IP Address Automatically from a DHCP Server

You can configure the unit to automatically obtain its IP address when it starts up from a DHCP server running on your network. With this method, the system can efficiently manage a limited number of IP addresses. Note that the IP address assigned to the unit may vary every time the unit is started up.

For details about the DHCP server, consult your network administrator.

Using a Static IP Address Specified by Your Network Administrator

If IP addresses for network devices are specified individually by your network administrator, you will need to manually configure settings such as the IP address, subnet mask, default gateway, and DNS servers. For details about the required network settings, consult your network administrator.

TCP/IP Settings for IPv6 (DHCP, RA or Static IP Address Assignment)

A unique IP address must be assigned to the unit so that it can communicate on the network. How you assign an IP address depends on your network environment. This unit supports the following 3 methods for assigning an IP address:

Obtaining an IP Address Automatically from a DHCP Server

You can configure the unit to automatically obtain its IP address when it starts up from a DHCP server running on your network. With this method, the system can efficiently manage a limited number of IP addresses. Note that the IP address assigned to the unit may vary every time the unit is started up. For details about the DHCP server, consult your network administrator.

Using a Static IP Address Specified by Your Network Administrator

If IP addresses for network devices are specified individually by your network administrator, you will need to manually configure settings such as the IP address, Prefix, default gateway, and DNS servers. For details about the required network settings, consult your network administrator.

Using a RA (Router Advertisement)

An IPv6 address can be assigned using Stateless Autoconfiguration. This enables the setting of addresses for only the router and the node without the need to manage information. For details about the required network settings, consult your network administrator.

DNS Server Settings

You can configure the unit to use 2 DNS servers: a primary DNS server is DNS1 and a secondary DNS server is DNS2. The primary DNS1 server receives priority over the secondary DNS2 server. If the primary DNS1 server returns no reply, the secondary DNS2 server will be used. For details about configuring the DNS server settings using the unit, or using the Web user interface, see **Configuring the Network Settings of the Unit** in this section.

DNS Priority Using Configuration File

The setting for DNS server(s) may be configured using the configuration files by your phone system dealer/service provider (→ see "DHCP_DNS_ENABLE", "DHCP_DNS_ENABLE_IPV6", "USER_DNS1_ADDR"/"USER_DNS2_ADDR" (for IPv4) and "USER_DNS1_ADDR_IPV6"/"USER_DNS2_ADDR_IPV6" (for IPv6) in **5.3.2 Basic Network Settings**).

- When "DHCP_DNS_ENABLE" (for IPv4) is set to "Y", you can manually configure the DNS server address by using "USER_DNS1_ADDR" or ("USER_DNS1_ADDR" and "USER_DNS2_ADDR"). When set to "N", the DNS server address will be automatically transmitted. This setting is available only when ("IP_ADDR_MODE"="0" or "IP_ADDR_MODE"="2") and "CONNECTION_TYPE"="1".
- When "DHCP_DNS_ENABLE_IPV6" (for IPv6) is set to "Y", you can manually configure the DNS server address by using "USER_DNS1_ADDR_IPV6" or ("USER_DNS1_ADDR_IPV6" and "USER_DNS2_ADDR_IPV6"). When set to "N", the DNS server address will be automatically transmitted. This setting is available only when ("IP_ADDR_MODE"="1" or "IP_ADDR_MODE"="2") and "CONNECTION_TYPE_IPV6"="1".





Configuring the Network Settings of the Unit

The following procedures explain how to change the network settings via the unit.

For details about the individual network settings that can be configured via the unit, refer to the Operating Instructions on the Panasonic Web site (→ see **Introduction**).









For details about configuring network settings via the Web user interface, see **4.3.1 Basic Network Settings**.

To configure IP Mode (IPv4, IPv6, IPv4&IPv6)







1. In standby mode, tap  or  to select "System Settings".
2. Tap "System Settings".
3. Tap "Network Settings".
4. Tap  or  to select "IP Mode Select".
5. Tap "IP Mode Select".
6. Tap "IPv4"/"IPv6"/"IPv4&IPv6".
 - The initial value is "IPv4".

Configuring the Network Settings Using IPv4

To configure network settings automatically



1. In standby mode, tap  or  to select "System Settings".
2. Tap "System Settings".
3. Tap "Network Settings".
4. Tap  or  to select "IPv4 Settings".
5. Tap  or  to select "Connection Mode".
6. Select "DHCP", and then tap "OK".
7. Tap  or  to select "DNS".
8. Select "Auto", and then tap "OK".
 - Select "Manual" to enter the addresses for DNS1 (primary DNS server) and, if necessary, DNS2 (secondary DNS server) manually, and then tap "OK".







To configure network settings manually

1. In standby mode, tap  or  to select "System Settings".
2. Tap "System Settings".
3. Tap "Network Settings".
4. Tap  or  to select "IPv4 Settings".
5. Tap  or  to select "Connection Mode".
6. Select "Static", and then tap "OK".
7. Enter the IP address, subnet mask, default gateway, DNS1 (primary DNS server), and, if necessary, DNS2 (secondary DNS server), and then tap "OK".







Configuring the Network Settings Using IPv6

To configure network settings automatically using DHCP







1. In standby mode, tap  or  to select "System Settings".
2. Tap "System Settings".
3. Tap "Network Settings".

4. Tap  or  to select "IPv6 Settings".
5. Tap  or  to select "Connection Mode".
6. Select "DHCP", and then tap "OK"
7. Tap  or  to select "DNS".
8. Select "Auto", and then tap "OK".
 - Select "Manual" to enter the addresses for DNS1 (primary DNS server) and, if necessary, DNS2 (secondary DNS server) manually, and then tap "OK".

To configure network settings automatically using RA

1. In standby mode, tap  or  to select "System Settings".
2. Tap "System Settings".
3. Tap "Network Settings".
4. Tap  or  to select "IPv6 Settings".
5. Tap  or  to select "Connection Mode".
6. Select "RA", and then tap "OK"
7. Enter the addresses for DNS1 (primary DNS server) and, if necessary, DNS2 (secondary DNS server) manually, and then tap "OK".

To configure network settings manually

1. In standby mode, tap  or  to select "System Settings".
2. Tap "System Settings".
3. Tap "Network Settings".
4. Tap  or  to select "IPv6 Settings".
5. Tap  or  to select "Connection Mode".
6. Select "Static", and then tap "OK"
7. Enter the IP address, subnet mask, default gateway, DNS1 (primary DNS server), and, if necessary, DNS2 (secondary DNS server), and then tap "OK".

Note

- If your phone system dealer/service provider does not allow you these settings, you cannot change them even though the unit shows the setting menu. Contact your phone system dealer/service provider for further information.
- If you select "DHCP" for the connection mode, all the settings concerning static connection will be ignored, even if they have been specified.
- If you select "DHCP" for the connection mode and "Auto" for DNS, the DNS server settings (DNS1 and DNS2) will be ignored, even if they have been specified.

1.1.4 Overview of Programming

There are 3 types of programming, as shown in the table below:

1.1.5 Phone User Interface Programming

Programming Type	Description	References
Phone user interface programming	Configuring the unit's settings directly from the unit.	→ 1.1.5 Phone User Interface Programming → 3 Phone User Interface Programming
Web user interface programming	Configuring the unit's settings by accessing the Web user interface from a PC connected to the same network.	→ 1.1.6 Web User Interface Programming → 4 Web User Interface Programming
Configuration file programming	Configuring the unit's settings beforehand by creating configuration files (pre-provisioning), and having the unit download the files from a server on the Internet and configure its own settings (provisioning).	→ 2 General Information on Provisioning → 5 Configuration File Programming

1.1.5 Phone User Interface Programming

You can change the settings directly from the unit.

For details about the operations, refer to the Operating Instructions on the Panasonic Web site (→ see **Introduction**).

For details about additional features available with direct commands, see **3 Phone User Interface Programming**.

1.1.5.1 Changing the Language for Phone User Interface Programming

You can change the language used on the LCD. Because the language settings for the LCD of the unit are not synchronized, you must set the languages individually for the unit.

For details about changing the setting, refer to the Operating Instructions on the Panasonic Web site (→ see **Introduction**).

1.1.6 Web User Interface Programming

After connecting the unit to your network, you can configure the unit's settings by accessing the Web user interface from a PC connected to the same network. For details, see **4 Web User Interface Programming**.

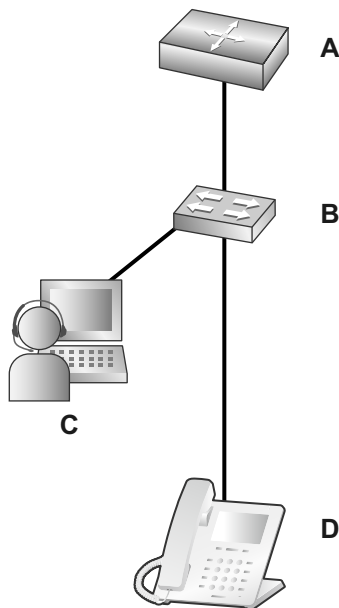

- A. Router
- B. Switching Hub
- C. PC
- D. SIP Phone

1.1.6.1 Password for Web User Interface Programming

To program the unit via the Web user interface, a login account is required. There are 2 types of accounts, and each has different access privileges.

- **User:** User accounts are for use by end users. Users can change the settings that are specific to the unit.
- **Administrator:** Administrator accounts are for use by administrators to manage the system configuration. Administrators can change all the settings, including the network settings, in addition to the settings that can be changed from a User account.

A separate password is assigned to each account.

For details, see **Access Levels (IDs and Passwords)** in **1.1.6.3 Before Accessing the Web User Interface**.

Notice

- You should manage the passwords carefully, and change them regularly.

1.1.6.2 Changing the Language for Web User Interface Programming

When accessing the unit via the Web user interface on a PC connected to the same network, various menus and settings are displayed. You can change the language used for displaying these setting items. Because the language setting for the Web user interface is not synchronized with those of the unit, you must set the languages for each independently.

For details, see **4.4.1 Language Settings**.

1.1.6.3 Before Accessing the Web User Interface

Recommended Environment

This unit supports the following specifications:

HTTP Version	HTTP/1.0 (RFC 1945), HTTP/1.1 (RFC 2616)
Authentication Method	Digest

The Web user interface will operate correctly in the following environments:





Operating System	Microsoft® Windows® 7 or Windows 8 operating system
Web Browser	Windows Internet Explorer® 7, Windows Internet Explorer 8, Windows Internet Explorer 9, Windows Internet Explorer 10, Windows Internet Explorer 11 web browser, Firefox® (32.0.3), Google® Chrome™ (37.0.2062.103)
Language (recommended)	English

Opening/Closing the Web Port





To access the Web user interface, you must open the unit's Web port beforehand. For details, refer to the Operating Instructions on the Panasonic Web site (→ see **Introduction**).

Configuring Settings from the Unit

To open the unit's Web port

1. In standby mode, tap  or  to select "Basic Settings".
2. Tap "Basic Settings".
3. Tap  or  to select "Other Option".
4. Tap "Other Option".
5. Tap "Embedded Web".
6. Select "On", and then tap "OK".

To close the unit's Web port

1. In standby mode, tap  or  to select "Basic Settings".
2. Tap "Basic Settings".
3. Tap  or  to select "Other Option".
4. Tap "Other Option".
5. Tap "Embedded Web".
6. Select "off", and then tap "OK".

Configuring Settings from the Web User Interface

To close the unit's Web port

1. In the Web user interface, click **[Web Port Close]**.
2. Click **OK**.

Note

- The Web port of the unit will be closed automatically in the following conditions:
 - 3 consecutive unsuccessful login attempts occur.
- The Web port can be set to stay open continuously, through Configuration file programming (→ see "**HTTPD_PORTOPEN_AUTO**" in **5.3.8 HTTPD/WEB Settings**). However, please recognize the possibility of unauthorized access to the unit by doing so.

Access Levels (IDs and Passwords)

2 accounts with different access privileges are provided for accessing the Web user interface: User and Administrator. Each account has its own ID and password, which are required to log in to the Web user interface.

Account	Target User	ID (default)	Password (default)	Password Restrictions
User	End users	user	-blank-(NULL)	<ul style="list-style-type: none"> • When logged in as User, you can change the password for the User account (→ see 4.4.2 User Password Settings). • The password can consist of 6 to 64 ASCII characters (case-sensitive) (→ see Entering Characters in 1.1.6.4 Accessing the Web User Interface).
Administrator	Network administrators, etc.	admin	adminpass	<ul style="list-style-type: none"> • When logged in as Administrator, you can change the password for both the User and Administrator accounts (→ see 4.4.3 Admin Password Settings). • The password can consist of 6 to 64 ASCII characters (case-sensitive) (→ see Entering Characters in 1.1.6.4 Accessing the Web User Interface).

Notice

- Only one account can be logged in to the Web user interface at a time. If you try to access the Web user interface while someone is logged in, you will be denied access.
- You cannot log in to the Web user interface even under the same account as someone who is already logged in.
- The user password is required to change the settings.
- The IDs can be changed through configuration file programming (→ see "**ADMIN_ID**" and "**USER_ID**" in **5.3.8 HTTPD/WEB Settings**).
- If you forget your account IDs or passwords, consult your phone system dealer/service provider.





1.1.6.4 Accessing the Web User Interface

The unit can be configured from the Web user interface.

To access the Web user interface

1. Open your Web browser, and then enter "http://" followed by the unit's IP address into the address field of your browser.
 - a. When the IP address is 192.168.0.1 (IPv4), access the following URL.
http://192.168.0.1/
 - b. When the IP address is 2001:db8:1f70::999:de8:7648:6e8 (IPv6), access the following URL. With IPv6, the IP address is enclosed in square brackets ("[" and "]").
http://[2001:db8:1f70::999:de8:7648:6e8]/

Note

- To determine the unit's IP address, perform the following operations on the unit:
 1. In standby mode, tap  or  to select "**System Settings**".
 2. Tap "**System Settings**".
 3. Tap "**Status**".
 4. Tap  or  to select "**IPv4 Settings**"/"**IPv6 Settings**".
 5. Tap "**IP Address**". (IPv6 only)
2. For authentication, enter your ID (username) and password, and then click **OK**.

Notice

- The default ID for the User account is "user", and the default password is blank. The ID cannot be changed from the Web user interface, but it can be changed through configuration file programming.
 - When you log in as User to the Web user interface for the first time, the **[User Password Settings]** screen (→ see **4.4.2 User Password Settings**) will be displayed. Enter a new password, and then perform authentication again with the new password to log in to the Web user interface.
 - The default ID for the Administrator account is "admin", and the default password is "adminpass". The ID cannot be changed from the Web user interface, but it can be changed through configuration file programming.
3. The Web user interface window is displayed. Configure the settings for the unit as desired.
 4. You can log out from the Web user interface at any time by clicking **[Web Port Close]**.

Controls on the Window

The Web user interface window contains various controls for navigating and configuring settings. The following figure shows the controls that are displayed on the **[Basic Network Settings]** screen as an example:

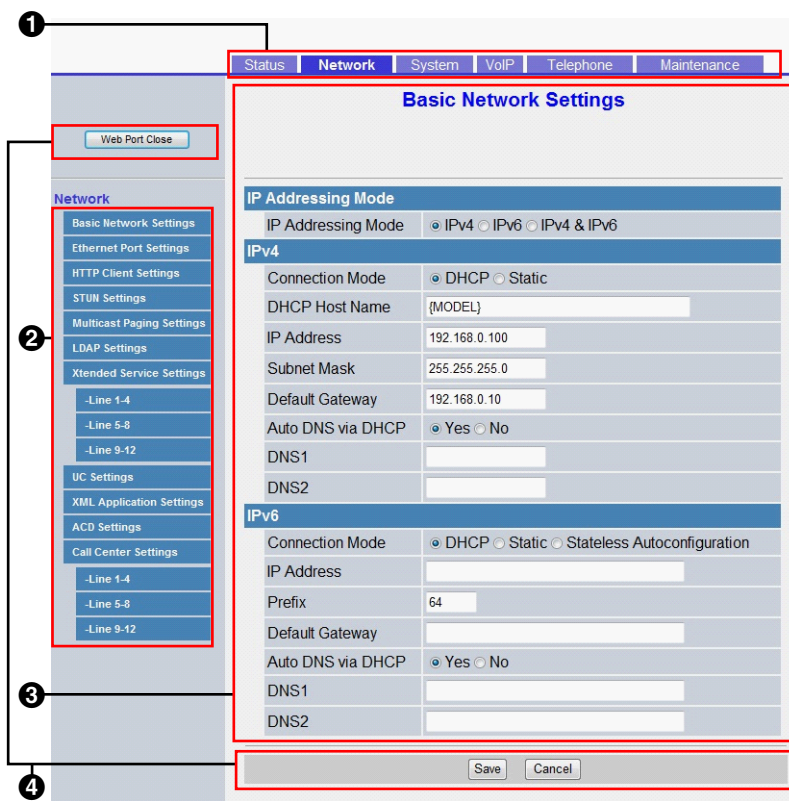

Note

- Actual default values may vary depending on your phone system dealer/service provider.
- When you log in to the Web user interface with the User account, the languages of messages displayed on the configuration screen may differ depending on the country/area of use.

1 Tabs

Tabs are the top categories for classifying settings. When you click a tab, the corresponding menu items and the configuration screen of the first menu item appear. There are 6 tabs for the Administrator account and 3 tabs for the User account. For details about the account types, see **Access Levels (IDs and Passwords)** in this section.

2 Menu

The menu displays the sub-categories of the selected tab.

3 Configuration Screen

Clicking a menu displays the corresponding configuration screen, which contains the actual settings, grouped into sections. For details, see **4.2 Status** to **4.7.5 Restart**.

4 Buttons

The following standard buttons are displayed in the Web user interface:

Button	Function
Web Port Close	Closes the Web port of the unit and logs you out of the Web user interface after a confirmation message is displayed.
Save	Applies changes and displays a result message (→ see Result Messages in this section).
Cancel	Discards changes. The settings on the current screen will return to the values they had before being changed.

Button	Function
Refresh	Updates the status information displayed on the screen. This button is displayed in the upper-right area of the [Network Status] and [VoIP Status] screens.

Entering Characters

In the Web user interface, when specifying a name, message, password, or other text item, you can enter any of the ASCII characters displayed in the following table with a white background.

	00	01	02	03	04	05	06	07	08	09	0A	0B	0C	0D	0E	0F
20	SP	!	"	#	\$	%	&	'	()	*	+	,	-	.	/
30	0	1	2	3	4	5	6	7	8	9	:	;	<	=	>	?
40	@	A	B	C	D	E	F	G	H	I	J	K	L	M	N	O
50	P	Q	R	S	T	U	V	W	X	Y	Z	[\]	^	_
60	`	a	b	c	d	e	f	g	h	i	j	k	l	m	n	o
70	p	q	r	s	t	u	v	w	x	y	z	{		}	~	

However, there are additional limitations for certain types of fields as follows:

- Number field
 - You may only enter a sequence of numeric characters.
- IP Address field
 - You can enter the IP address using dotted-decimal notation (i.e., "n.n.n.n" where n=0–255).
 - With IPv6, you can enter the IP address using dotted-decimal notation (i.e., "n:n:n:n:n:n:n:n" where n=0-FFFF, abbreviation available).
- FQDN field
 - You can enter the IP address using dotted-decimal notation (i.e., "n.n.n.n" where n=0–255).
 - With IPv6, the IP address is enclosed in square brackets ("[" and "]").
Example: http://[2001:db8:1f70::999:de8:7648:6e8]/
- Display Name field (→ see **[Display Name]** in **4.6.2.1 Call Features**)
 - This is the only field in which you can enter Unicode characters.

Result Messages

When you click **[Save]** after changing the settings on the current configuration screen, one of the following messages will appear in the upper-left area of the current configuration screen:

Result Message	Description	Applicable Screens
Complete	The operation has successfully completed.	All screens except 4.6.7 Export Phonebook

Result Message	Description	Applicable Screens
Failed (Parameter Error)	The operation failed because: <ul style="list-style-type: none"> Some specified values are out of range or invalid. 	All screens
Failed (Memory Access Failure)	The operation failed because: <ul style="list-style-type: none"> Access error to the flash memory occurred while reading or writing the data. 	All screens
Failed (Transfer Failure) ^{*1}	The operation failed because: <ul style="list-style-type: none"> A network error occurred during the data transmission. 	All screens
Failed (Busy)	The operation failed because: <ul style="list-style-type: none"> The unit is in an operation that accesses the flash memory of the unit. 	All screens
	<ul style="list-style-type: none"> When attempting to import/export the phonebook data, the unit is on a call. While transferring the phonebook data, a call arrived at the unit. 	
Failed (Canceled)	The operation failed because: <ul style="list-style-type: none"> While transferring the phonebook data, the connection with the unit was interrupted. 	4.6.6 Import Phonebook 4.6.7 Export Phonebook
Failed (Invalid File)	The operation failed because: <ul style="list-style-type: none"> Analysis of the received data failed. 	4.6.6 Import Phonebook
Failed (File Size Error)	The operation failed because: <ul style="list-style-type: none"> The size of the imported phonebook is too large. 	4.6.6 Import Phonebook
No Data	The operation failed because: <ul style="list-style-type: none"> The imported phonebook file contains no valid phonebook entries. 	4.6.6 Import Phonebook
	<ul style="list-style-type: none"> No phonebook entry is registered in the export source the unit. 	4.6.7 Export Phonebook

*1 "Failed (Transfer Failure)" may not be displayed depending on your Web browser.

1.2 Firmware Update

1.2.1 Firmware Update

You can update the unit's firmware to improve the unit's operation. You can configure the unit so that it automatically downloads the new firmware file from a specified location. The firmware update will be executed when the unit is restarted.

For details, see **7 Firmware Update**.

1.2.1 Firmware Update

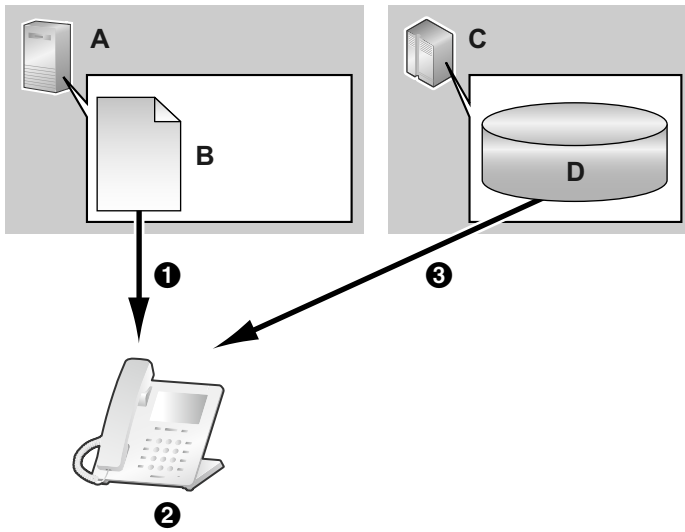

- A. Provisioning server
- B. Configuration file
- C. Firmware server
- D. Firmware

- ① Download
- ② Check for update
- ③ Firmware download and update

Section 2

General Information on Provisioning

This section provides an overview of the configuration file programming procedures for the unit, including pre-provisioning and provisioning.

2.1 Pre-provisioning

2.1.1 What is Pre-provisioning?

Pre-provisioning is an auto-provisioning mechanism that automatically obtains the server address saved in the configuration file administered by the carrier or distributor.

There are two methods for automatically obtaining the server address saved in the configuration file.

1. SIP PnP
The phone multicasts a SIP SUBSCRIBE message and obtains a provisioning server address via a SIP NOTIFY message.
2. DHCP options
The phone obtains a provisioning server address via the DHCP option information. DHCP options 66, 159 and 160 will be used when the phone's IP address mode is IPv4, and DHCP option 17 will be used when the phone's IP address mode is IPv6.

2.1.2 How to Obtain a Pre-provisioning Server Address

Upon startup, the phone will attempt to obtain a pre-provisioning server address as follows.

1. When the phone's IP address mode is IPv4
The phone will attempt to obtain a pre-provisioning server address using SIP PnP, but when it cannot, it will attempt to do so from DHCPv4 options.
2. When the phone's IP address mode is IPv6
The phone will attempt to obtain a pre-provisioning server address from DHCPv6 options.
3. When the phone's IP address mode is IPv4/v6 Dual
The phone will attempt to obtain a pre-provisioning server address using SIP PnP, but when it cannot, it will attempt to do so from DHCPv4 options. When this is not possible, it will attempt to do so from DHCPv6 options.

Note

- The SIP PnP function is enabled in the initial state. It can be enabled or disabled from the configuration parameter "`SIPPNP_PROV_ENABLE`".

2.1.3 Server Address Formats

1. Basic format
Format: <scheme>://<user>:<password>@<host>:<port>/<url-path>/<file name>
* The server name (<host>) may be the IP address or the domain.
* Maximum length: 384 characters
2. Macros used with file names

Macro Format {XXXX}	Macro Expansion
{MAC}	If the URL contains {MAC}, it will be replaced with the device's MAC address in uppercase letters. Example: {MAC} → 0080F0C571EB
{mac}	If the URL contains {mac}, it will be replaced with the device's MAC address in lowercase letters. Example: {mac} → 0080f0c571eb
{MODEL}	If the URL contains {MODEL}, it will be replaced with the device's model name. Example: {MODEL} → KX-HDV430

Macro Format {XXXX}	Macro Expansion
{fwver}	If the URL contains {fwver}, it will be replaced with the device's firmware version. Example: {fwver} → 01.000

Note

- Macros distinguish between uppercase and lowercase letters.
- Macros not specified above will be treated as strings of characters.

2.1.4 Obtaining a Provisioning Server Address via SIP PnP

1. Basic Sequence

At startup, the phone will multicast a SIP SUBSCRIBE message for the ua-profile event, receive a SIP NOTIFY message from the PnP server and obtain a pre-provisioning server address. It will then obtain a provisioning server address from the pre-provisioning server.

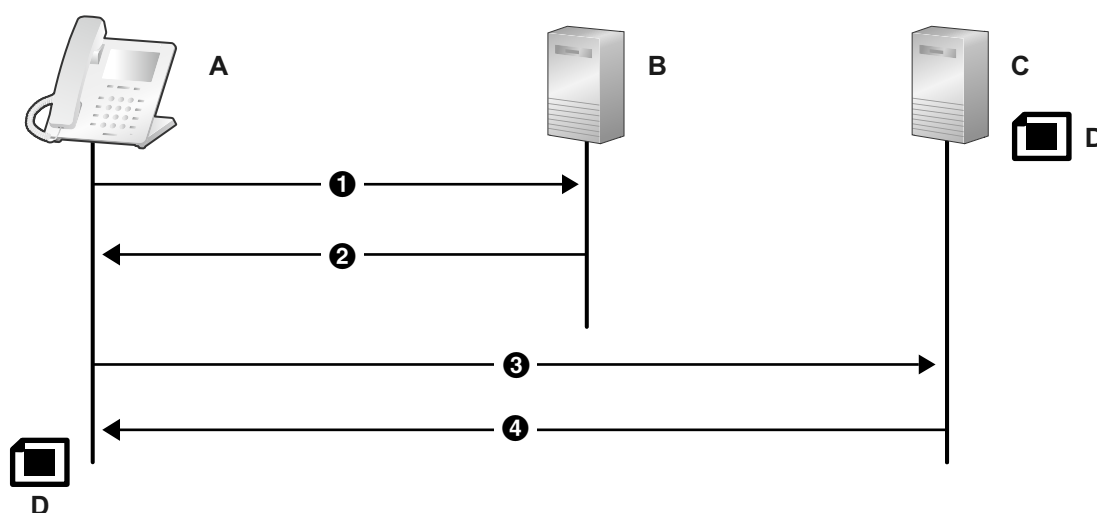

- A. SIP Phone
 B. PnP Server
 C. Pre-provisioning Server
 D. xxxxxxxxxxxx.cfg

- ① SUBSCRIBE (multicast)
 ② NOTIFY (unicast)
 Body http://server/{MODEL}.cfg
 ③ HTTP GET {MODEL}.cfg
 ④ 200OK

Obtain provisioning server information
 CFG_STANDARD_FILE_PATH
 CFG_PRODUCT_FILE_PATH

2.1.5 Obtaining a Provisioning Server Address from DHCP Options

CFG_MASTER_FILE_PATH

2. Provisioning server URL formats

Format: <scheme>://<user>:<password>@<host>:<port>/<url-path>/<file name>

<scheme>	Mandatory	Protocol (TFTP/FTP/HTTP/HTTPS)
<user>	Optional	User name
<password>	Optional	Password
<host>	Mandatory	IP Address or Domain
<port>	Optional	Port number
<url-path>	Optional	Full path of the resource
<file name>	Mandatory	File name

1. Case 1: Protocol, server name and file name
http://10.0.0.1/{MODEL}.cfg
http://prov.com/{MODEL}.cfg
2. Case 2: Protocol, server name, path and file name
http://10.0.0.1/pana/{MODEL}.cfg
http://prov.com/pana/{MODEL}.cfg
3. Case 3 Protocol, user name, password, server name and file name
http://id:pass@10.0.0.1/{MAC}.cfg
http://id:pass@prov.com/{MAC}.cfg

2.1.5 Obtaining a Provisioning Server Address from DHCP Options

1. DHCPv4

a. Basic Sequence

In a DHCPv4 environment, the phone will transmit a DHCP DISCOVER message for DHCP options (66, 67, 159 and 160), receive a DHCP OFFER message, obtain a pre-provisioning server address and obtain a provisioning server address from the pre-provisioning server.

Note

- DHCP options (66, 159 and 160) are enabled in the initial state and can be enabled and disabled from the configuration parameters.

DHCP options	Configuration parameter	Priority
Option 66	OPTION66_ENABLE	3
Option 159	OPTION159_PROV_ENABLE	2
Option 160	OPTION160_PROV_ENABLE	1

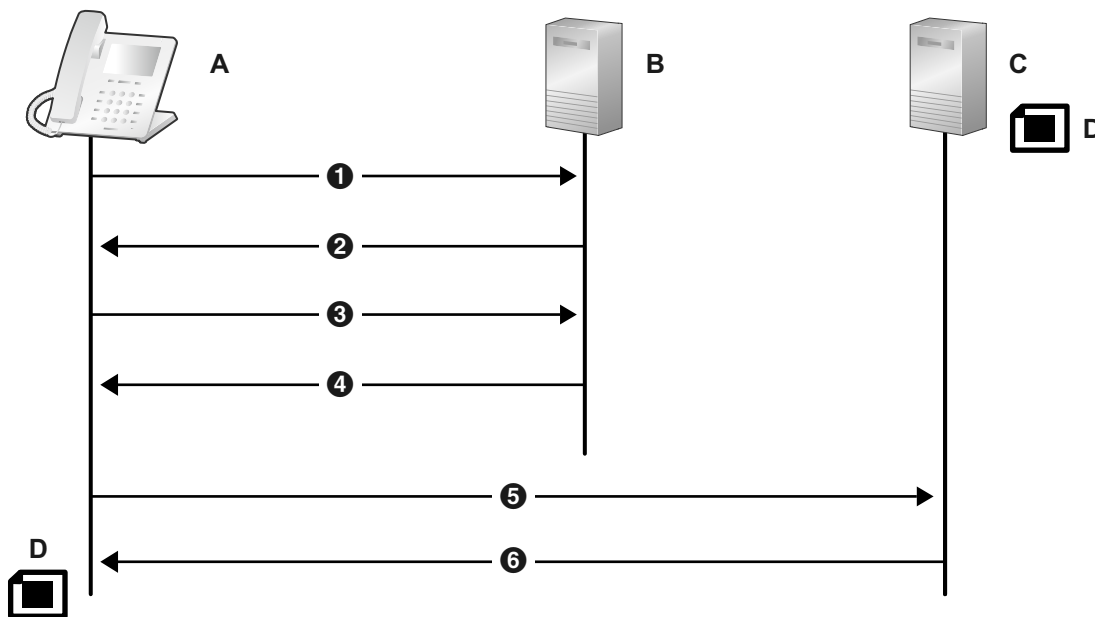

- A. SIP Phone
- B. DHCP Server
- C. Pre-provisioning Server
- D. KX-HDV430.cfg

- ① DHCP DISCOVER
- ② DHCP OFFER
- ③ DHCP REQUEST
- ④ DHCP ACK
- ⑤ TFTP {MODEL}.cfg
- ⑥ 200OK

Obtain provisioning server information

```
CFG_STANDARD_FILE_PATH
CFG_PRODUCT_FILE_PATH
CFG_MASTER_FILE_PATH
```

- b. Format for pre-provisioning files obtained from DHCP option 67
Format: <path>/<file name>

<path>	Optional	path
<file name>	Mandatory	file name

- 1. Case 1: File name only
{MODEL}.cfg
- 2. Case 2: Path and file name
pana/{MODEL}.cfg

2.1.5 Obtaining a Provisioning Server Address from DHCP Options

- c. Format for pre-provisioning server address obtained from DHCP options 159 and 160
Format: <scheme>://<user>:<password>@<host>:<port>/<url-path>

<scheme>	Mandatory	Protocol (TFTP/FTP/HTTP/HTTPS)
<user>	Optional	User name
<password>	Optional	Password
<host>	Mandatory	IP Address or Domain
<port>	Optional	Port number
<url-path>	Optional	Full path of the resource

The obtained file is the <path>/<file name> set in DHCP option 67.

If DHCP option 67 is not set, {MODEL}.cfg is obtained.

The examples in parentheses below are when {MODEL}.cfg is set for DHCP option 67.

1. Case 1: Protocol and server name
http://10.0.0.1 (http://10.0.0.1/{MODEL}.cfg)
http://prov.com (http://prov.com/{MODEL}.cfg)
 2. Case 2: Protocol, server name and path
http://10.0.0.1/pana (http://10.0.0.1/pana/{MODEL}.cfg)
http://prov.com/pana (http://prov.com/pana/{MODEL}.cfg)
 3. Case 3: Protocol, user name, password and server name
http://id:pass@10.0.0.1 (http://id:pass@10.0.0.1/{MODEL}.cfg)
http://id:pass@prov.com (http://id:pass@prov.com/{MODEL}.cfg)
- d. Format for pre-provisioning server address obtained from DHCP option 66
Format: <scheme>://<user>:<password>@<host>:<port>/<url-path>

<scheme>	Optional	Protocol (TFTP/FTP/HTTP/HTTPS)
<user>	Optional	User name
<password>	Optional	Password
<host>	Mandatory	IP Address or Domain
<port>	Optional	Port number
<url-path>	Optional	Full path of the resource

If DHCP option 66 does not include <scheme>, {MODEL}.cfg is obtained.

If the last character of DHCP option 66 is "/", {MODEL}.cfg is obtained.

Otherwise DHCP option 66 includes <file name>.

1. Case 1: Protocol and server name
http://10.0.0.1/ (http://10.0.0.1/{MODEL}.cfg)
http://prov.com/ (http://prov.com/{MODEL}.cfg)
2. Case 2: Protocol, server name and path
http://10.0.0.1/pana/ (http://10.0.0.1/pana/{MODEL}.cfg)
http://prov.com/pana/ (http://prov.com/pana/{MODEL}.cfg)
3. Case 3: Protocol, user name, password and server name
http://id:pass@10.0.0.1/ (http://id:pass@10.0.0.1/{MODEL}.cfg)
http://id:pass@prov.com/ (http://id:pass@prov.com/{MODEL}.cfg)
4. Case 4: Server name
tftp://10.0.0.1 (tftp://10.0.0.1/{MODEL}.cfg)
tftp://prov.com (tftp://prov.com/{MODEL}.cfg)

2. DHCPv6

- a. In a DHCPv6 environment, the phone will transmit a DHCPv6 REQUEST message for DHCP option 17, receive a DHCPv6 REPLY message, obtain a pre-provisioning server address and obtain a provisioning server address from the pre-provisioning server.

Note

- DHCP option 17 is enabled in the initial state and can be enabled and disabled from the configuration parameters ("DHCPV6_OPTION17_PROV_ENABLE").

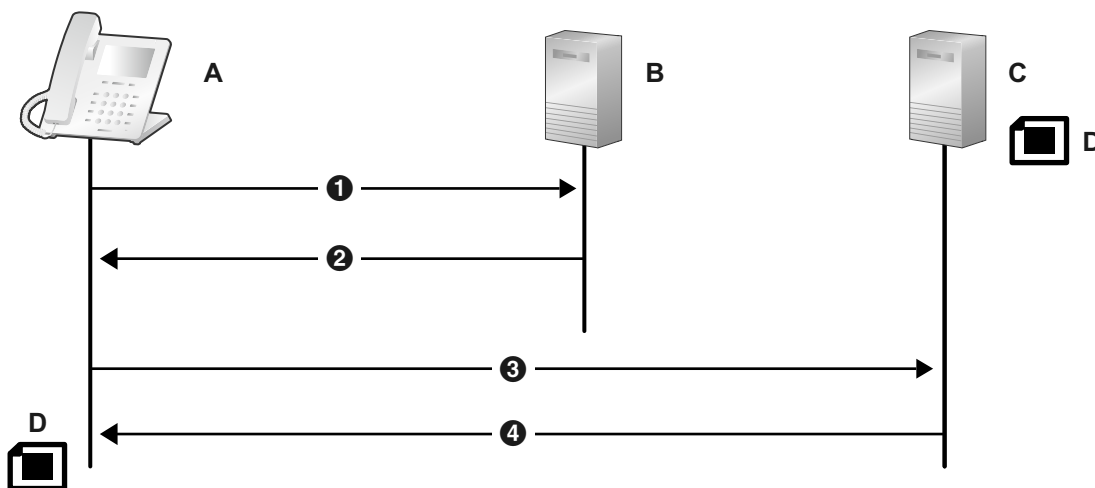

- A. SIP Phone
- B. DHCP Server
- C. Pre-provisioning Server
- D. KX-HDV430.cfg

- ① DHCPv6 REQUEST
- ② DHCPv6 REPLY
- ③ TFTP {MODEL}.cfg
- ④ 200OK

Obtain provisioning server information

```

CFG_STANDARD_FILE_PATH
CFG_PRODUCT_FILE_PATH
CFG_MASTER_FILE_PATH
    
```

- b. Format for pre-provisioning addresses obtained from DHCPv6 option 17
 Format: <scheme>://<user>:<password>@<host>:<port>/<url-path>

<scheme>	Mandatory	Protocol (TFTP/FTP/HTTP/HTTPS)
<user>	Optional	User name
<password>	Optional	Password
<host>	Mandatory	IP Address or Domain

<port>	Optional	Port number
<url-path>	Optional	Full path of the resource
<file name>	Mandatory	File name

1. Case 1: Protocol, server name, and file name
`http://[2001:0db8:bd05:01d2:288a:1fc0:0001:10ee]/{MODEL}.cfg`
`http://prov.com/{MODEL}.cfg`
2. Case 2: Protocol, server name, path and file name
`http://[2001:db8::1234:0:0:9abc]/pana/{MODEL}.cfg`
`http://prov.com/pana/{MODEL}.cfg`
3. Case 3: Protocol, user name, password, server name and file name
`http://id:pass@[2001:db8::9abc]/{MAC}.cfg`
`http://id:pass@prov.com/{MAC}.cfg`

2.2 Provisioning

2.2.1 What is Provisioning?

After pre-provisioning has been performed (→ see **2.1 Pre-provisioning**), you can set up the unit automatically by downloading the configuration file stored on the provisioning server into the unit. This is called "provisioning".

2.2.2 Protocols for Provisioning

Provisioning can be performed over HTTP, HTTPS, FTP, and TFTP. The protocol you should use differs depending on how you will perform provisioning. Normally, HTTP, HTTPS, or FTP is used for provisioning. If you are transmitting encrypted configuration files, it is recommended that you use HTTP. If you are transmitting unencrypted configuration files, it is recommended that you use HTTPS. You may not be able to use FTP depending on the conditions of the network router or the network to be used.

2.2.3 Configuration File

This section gives concrete examples of the functions of the configuration file and how to manage it. The configuration file is a text file that contains the various settings that are necessary for operating the unit. The files are normally stored on a server maintained by your phone system dealer/service provider, and will be downloaded to the units as required. All configurable settings can be specified in the configuration file. You can ignore settings that already have the desired values. Only change parameters as necessary. For details about setting parameters and their descriptions, see **5 Configuration File Programming**.

Using 3 Types of Configuration Files

The unit can download up to 3 configuration files. One way to take advantage of this is by classifying the configuration files into the following 3 types:

Type	Usage
Master configuration file	<p>Configure settings that are common to all units, such as the SIP server address, and the IP addresses of the DNS and NTP (Network Time Protocol) servers managed by your phone system dealer/service provider. This configuration file is used by all the units.</p> <p>Example of the configuration file's URL: <code>http://prov.example.com/Panasonic/ConfigCommon.cfg</code></p>

Type	Usage
Product configuration file	<p>Configure settings that are required for a particular model, such as the default setting of the privacy mode. This configuration file is used by all the units that have the same model name.</p> <p>The same number of configuration files as models being used on the network are stored on the provisioning server, and units with the same model name download the corresponding configuration file.</p> <p>Example of the configuration file's URL: http://prov.example.com/Panasonic/Config{MODEL}.cfg</p> <p>Note</p> <ul style="list-style-type: none"> When a unit requests the configuration file, "{MODEL}" is replaced by the model name of the unit.
Standard configuration file	<p>Configure settings that are unique to each unit, such as the phone number, user ID, password, etc.</p> <p>The same number of configuration files as units are stored on the provisioning server, and each unit downloads the corresponding standard configuration file.</p> <p>Example of the configuration file's URL: http://prov.example.com/Panasonic/Config{MAC}.cfg</p> <p>Note</p> <ul style="list-style-type: none"> When a unit requests the configuration file, "{MAC}" is replaced by the MAC address of the unit.

Depending on the situation, you can use all 3 types of configuration files, and can also use only a standard configuration file.

The above example shows only one possible way to use configuration files. Depending on the requirements of your phone system dealer/service provider, there are a number of ways to use configuration files effectively.

Using 2 Types of Configuration Files

The following table shows an example of using 2 types of configuration files: a master configuration file to configure settings common to all units, and product configuration files to configure settings common to particular groups.

Using Product Configuration Files According to the Position Groups

You can use product configuration files for different groups or for multiple users within the same group.

Department Name	URL of Product Configuration File
Sales	http://prov.example.com/Panasonic/ConfigSales.cfg
Planning	http://prov.example.com/Panasonic/ConfigPlanning.cfg

2.2.4 Downloading Configuration Files

Downloading a Configuration File via the Web User Interface

The following procedure describes how to enable downloading a configuration file via the Web User Interface to be used for programming the unit.

2.2.4 Downloading Configuration Files

1. Confirm that the provisioning server's IP address/FQDN and directory are correct, and store the configuration files in the directory (e.g., `http://provisioning.example.com/Panasonic/Config_Sample.cfg`).
2. Enter the IP address of the unit into the PC's Web browser (→ see **1.1.6.3 Before Accessing the Web User Interface**).
3. Log in as the administrator (→ see **Access Levels (IDs and Passwords)** in **1.1.6.3 Before Accessing the Web User Interface**).
4. Click the **[Maintenance]** tab, and then select **[Provisioning Maintenance]**.
5. Enter the URL set up in Step 1 in **[Standard File URL]**.
6. Click **[Save]**.

Timing of Downloading

A unit downloads configuration files when it starts up, at regular intervals, and when directed to do so by the server.

Download Timing	Explanation
Startup	The configuration files are downloaded when the unit starts up.

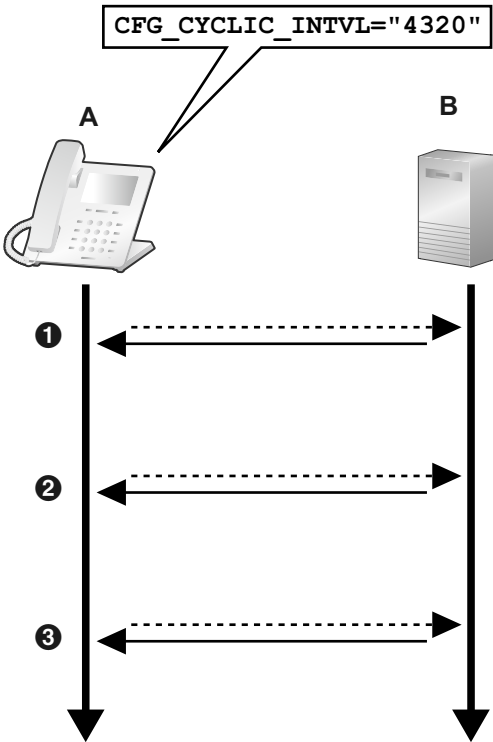
Download Timing	Explanation
<p>At regular intervals of time</p>	<p>The configuration files are downloaded at specified intervals of time, set in minutes. In the example below, the unit has been programmed to download configuration files from the provisioning server every 3 days (4320 minutes).</p> <div style="text-align: center; margin-bottom: 10px;"> <div style="border: 1px solid black; padding: 2px; display: inline-block;">CFG_CYCLIC_INTVL="4320"</div> </div>  <p>A. SIP Phone B. Provisioning Server</p> <p>① Power on ② 3 days later ③ 6 days later</p> <p>---▶ : Check ◀ : Download</p>

2.2.4 Downloading Configuration Files

Download Timing	Explanation
	<p>The configuration files are downloaded periodically under the following conditions:</p> <ul style="list-style-type: none">• In the configuration file, add the line, <code>CFG_CYCLIC="Y"</code>.<ul style="list-style-type: none">– Set an interval (minutes) by specifying "<code>CFG_CYCLIC_INTVL</code>".• In the Web user interface:<ul style="list-style-type: none">– Click the [Maintenance] tab, click [Provisioning Maintenance], and then select [Yes] for [Cyclic Auto Resync].– Enter an interval (minutes) in [Resync Interval]. <p>Note</p> <ul style="list-style-type: none">• The interval may be determined by your phone system dealer/ service provider. A maximum interval of 28 days (40320 minutes) can be set on the unit.

Download Timing	Explanation
<p>At a specified time each day</p>	<p>After the unit is powered on, it will download configuration files once per day at the specified time.</p> <div data-bbox="778 405 1262 1144" style="text-align: center;"> </div> <p>A. SIP Phone B. Provisioning Server</p> <p>① power on at 12:00 ② 02:00 ③ 02:00</p> <p>---▶ : Check ◀ : Download</p> <ul style="list-style-type: none"> In the configuration file: <ul style="list-style-type: none"> Set a time by specifying "CFG_RESYNC_TIME". In the Web user interface: <ul style="list-style-type: none"> Click the [Maintenance] tab, click [Provisioning Maintenance], and then enter the time in [Time Resync]. <p>Note</p> <ul style="list-style-type: none"> The time is specified using a 24-hour clock ("00:00" to "23:59").

2.2.5 Provisioning Server Setting Example

Download Timing	Explanation
When directed	<p>When a setting needs to be changed immediately, units can be directed to download the configuration files by sending them a NOTIFY message that includes a special event from the SIP server.</p> <ul style="list-style-type: none"> • In the configuration file: <ul style="list-style-type: none"> – Specify the special event text in "CFG_RESYNC_FROM_SIP". • In the Web user interface: <ul style="list-style-type: none"> – Click the [Maintenance] tab, click [Provisioning Maintenance], and then enter the special event text in [Header Value for Resync Event]. <p>Generally, "check-sync" or "resync" is set as the special event text.</p>

2.2.5 Provisioning Server Setting Example

This section gives an example of how to set up the units and provisioning server when configuring 2 units with configuration files. The standard configuration files and the master configuration file are used in this example.

Conditions

Item	Description/Setting
Provisioning server FQDN	prov.example.com
Units' MAC addresses	<ul style="list-style-type: none"> • 0080F0111111 • 0080F0222222
URL of the configuration files	<p>Configure the following 2 settings either by pre-provisioning or through the Web user interface. The values of both settings must be the same.</p> <ul style="list-style-type: none"> • CFG_STANDARD_FILE_PATH="http://prov.example.com/Panasonic/Config{MAC}.cfg" • CFG_MASTER_FILE_PATH="http://prov.example.com/Panasonic/ConfigCommon.cfg"
Directory on the provisioning server containing the configuration files	Create the "Panasonic" directory just under the HTTP root directory of the provisioning server.
File name of configuration files	<p>Store the following configuration files in the "Panasonic" directory.</p> <ul style="list-style-type: none"> • Contains the common settings for the 2 units: <ul style="list-style-type: none"> – ConfigCommon.cfg • Contains the settings unique to each unit: <ul style="list-style-type: none"> – Config0080F0111111.cfg – Config0080F0222222.cfg

To set up the provisioning server

1. Connect the units to the network, and turn them on.
 - a. The unit with the MAC address 0080F0111111 accesses the following URLs:
 - http://prov.example.com/Panasonic/ConfigCommon.cfg
 - http://prov.example.com/Panasonic/Config0080F0111111.cfg

- b. The unit with the MAC address 0080F0222222 accesses the following URLs:
<http://prov.example.com/Panasonic/ConfigCommon.cfg>
<http://prov.example.com/Panasonic/Config0080F0222222.cfg>

Example Provisioning Direction from the Server

The following figure shows an example NOTIFY message from the server, directing the units to perform provisioning. The text "check-sync" is specified for "CFG_RESYNC_FROM_SIP".

```
NOTIFY sip:1234567890@sip.example.com SIP/2.0
Via: SIP/2.0/UDP xxx.xxx.xxx.xxx:5060;branch=abcdef-ghijkl
From: sip:prov@sip.example.com
To: sip:1234567890@sip.example.com
Date: Wed, 1 Jan 2014 01:01:01 GMT
Call-ID: 123456-1234567912345678
CSeq: 1 NOTIFY
Contact: sip:xxx.xxx.xxx.xxx:5060
Event: check-sync
Content-Length: 0
```

2.2.6 Encryption

Secure Provisioning Methods

In order to perform provisioning securely, there are 2 methods for transferring configuration files securely between the unit and the server.

Which method is used depends on the environment and equipment available from the phone system.

Method 1: Transferring Encrypted Configuration Files

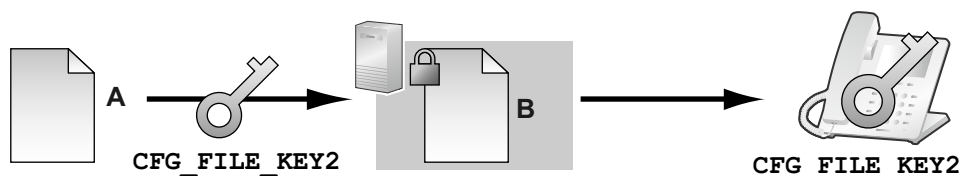

- A. Unencrypted configuration file
 B. Encrypted configuration file

To use this method, an encryption key is required to encrypt and decrypt the configuration files. A preset encryption key unique to each unit, an encryption key set by your phone system dealer/service provider, etc., is used for the encryption. When the unit downloads an encrypted configuration file, it will decrypt the file using the same encryption key, and then configure the settings automatically.

Method 2: Transferring Configuration Files Using HTTPS

This method uses SSL, which is commonly used on the Internet, to transfer configuration files between the unit and server. For more secure communication, you can use a root certificate.

Notice

- To avoid redundant data transfer over the network, important data, such as the encryption key used to encrypt the configuration files and the root certificate for SSL, should be configured through pre-provisioning as much as possible.

2.3 Priority of Setting Methods

- It is recommended that you encrypt the data in order to keep the communication secure when transferring configuration files.
However, if you are using the units within a secure environment, such as within an intranet, it is not necessary to encrypt the data.

To decrypt configuration files, the unit uses the encryption key registered to it beforehand. The unit determines the encryption status by checking the extension of the downloaded configuration file. For details about encrypting configuration files, contact the appropriate person in your organization.

Extension of Configuration File	Configuration File Parameters Used for Decrypting
".e2c"	CFG_FILE_KEY2
".e3c"	CFG_FILE_KEY3
Other than ".e2c", and ".e3c"	Processed as unencrypted configuration files. The extension ".cfg" should be used for unencrypted configuration files.

Comparison of the 2 Methods

The following table compares the characteristics for the 2 transfer methods.

	Transferring Encrypted Configuration Files	Transferring Configuration Files Using HTTPS
Provisioning server load	Light	Heavy (The server encrypts data for each transmission.)
Operation load	Necessary to encrypt data beforehand.	Unnecessary to encrypt data beforehand.
Management of configuration files	Files must be decrypted and re-encrypted for maintenance.	It is easy to manage files because they are not encrypted on the server.
Security of data on the server when operating	High	Low (Configuration files are readable by anyone with access to the server.)

Moreover, there is another method: configuration files are not encrypted while stored on the server, and then, using the encryption key registered to the unit beforehand, they are encrypted when they are transferred. This method is particularly useful when several units are configured to download a common configuration file using different encryption keys. However, as when downloading an unencrypted configuration file using HTTPS, the server will be heavily burdened when transferring configuration files.

2.3 Priority of Setting Methods

The same settings can be configured by different configuration methods: provisioning, Web user interface programming, etc. This section explains which value is applied when the same setting is specified by multiple methods.

The following table shows the priority with which settings from each method are applied (lower numbers indicate higher priority):

Priority	Setting Method
3	The factory default settings for the unit
2	Pre-provisioning with the configuration file

Priority	Setting Method	
1	1-1	Provisioning with the standard configuration file
	1-2	Provisioning with the product configuration file
	1-3	Provisioning with the master configuration file
	Settings configured from the Web user interface or the phone user interface	

According to the table, settings configured later override previous settings (i.e., settings listed lower in the table have a higher priority).

Notice

- Make sure to perform Reset to Factory Default before connecting the unit to a different phone system. Contact your phone system dealer/service provider for further information.

2.4 Configuration File Specifications

The specifications of the configuration files are as follows:

File Format

The configuration file is in plain text format.

Lines in Configuration Files

A configuration file consists of a sequence of lines, with the following conditions:

- Each line must end with "<CR><LF>".

Note

<CR> or <LF> alone may be acceptable under certain conditions.

- Lines that begin with "#" are considered comments.
- Configuration files must start with a comment line containing the following designated character sequence (44 bytes):

```
# Panasonic SIP Phone Standard Format File #
```

The hexadecimal notation of this sequence is:

```
23 20 50 61 6E 61 73 6F 6E 69 63 20 53 49 50 20
50 68 6F 6E 65 20 53 74 61 6E 64 61 72 64 20 46
6F 72 6D 61 74 20 46 69 6C 65 20 23
```

- To prevent the designated character sequence being altered by chance, it is recommended that the configuration file starts with the comment line shown below:
Panasonic SIP Phone Standard Format File # DO NOT CHANGE THIS LINE!
- Configuration files must end with an empty line.
- Each parameter line is written in the form of XXX="yyy" (XXX: parameter name, yyy: parameter value). The value must be enclosed by double quotation marks.
- A parameter line written over multiple lines is not allowed. It will cause an error on the configuration file, resulting in invalid provisioning.

Configuration Parameters

- The unit supports multiple telephone lines. For some parameters, the value for each line must be specified independently. A parameter name with the suffix "_1" is the parameter for line 1; "_2" for line 2; ...; "_16" for line 16, and so on.

Examples of setting the line (phone number) for accessing a voice mail server:

2.4 Configuration File Specifications

"VM_NUMBER_1": for line 1,
"VM_NUMBER_2": for line 2, ...
"VM_NUMBER_16": for line 16

Note

- The number of lines available varies depending on the phone being used, as follows:
 - KX-HDV430: 1–16
- Some parameter values can be specified as "empty" to set the parameter values to empty.
Example:
`NTP_ADDR=""`
- The parameters have no order.
- If the same parameter is specified in a configuration file more than once, the value specified first is applied.
- All configurable settings can be specified in the configuration file. You can ignore settings that already have the desired values. Only change parameters as necessary.
- Boolean parameters (BOOLEAN) accept all of the following configurations.
"Y": "Y", "y", "Yes", "YES", "yes"
"N": "N", "n", "No", "NO", "no"

Parameter Extensions

You can use parameter extensions to specify parameters as Read-Only or Carrier Default.

Read-Only Specification

- When "?R" or "?r" is specified, the phone user interface and Web user interface for the parameter in question is restricted to Read-Only.
 - * Restricting the phone user interface to Read-Only
The Read-Only parameter settings menu appears, but an error occurs during registration.
 - * Restricting the Web user interface to Read-Only
The Read-Only parameter settings menu appears grayed out and nothing can be entered.

Note

- Parameters that can be configured from the device and from the Web can be confirmed from footnotes 1-3 on the parameter names in "5.1 Configuration File Parameter List".
- When "?R" or "?r" is not specified, the phone user interface and Web user interface are both readable and writable.
 - * Optional specifications for "?R" and "?r" are enabled when the last parameter in question is configured.
Example:
(1) Import XXX?R="111" from the Web as a standard file.
 - XXX: Read-Only
 - XXX operational information: 111
 - (2) Import XXX="222" from the Web as a product file.
 - XXX : Read/Write
 - XXX operational information: 222
 - * When configurations in (1) and (2) are used, the higher priority standard file will be enabled and the value for XXX in Read-Only mode will be 111.

Carrier Default Specification

- When "?" is specified, applicable parameter values are managed as carrier default values when applied to operational information.
 - * Carrier default values are applied once a reset to carrier defaults is executed. Carrier defaults will also be initialized when a reset to device defaults is executed.
 - * Once "?" is specified, the parameter in question will be designated as a carrier default even if said parameter is configured without "?". (This setting will remain in place until restored to factory default.)

Specification of Multiple Parameter Extensions

- One parameter can be assigned multiple extensions.
Example: XXX?R?!="" / XXX?!?r=""

Parameter Extension Configuration Example

1. In the configuration file, set IP Addressing Mode to IPv4 and Read-Only
Example parameter: IP_ADDR_MODE?R="0" ("0": IPv4)
2. If an error occurs when attempting to set the IP Mode to IPv6, see **To configure IP Mode (IPv4, IPv6, IPv4&IPv6)** in **Configuring the Network Settings of the Unit**.

2.5 Configuration File Examples

The following examples of configuration files are provided on the Panasonic Web site (→ see **Introduction**).

- Simplified Example of the Configuration File
- Comprehensive Example of the Configuration File

2.5.1 Examples of Codec Settings

Setting the Codec Priority to (1)G.729A, (2)PCMU, (3)G.722

```
## Codec Settings
# Enable G722
CODEC_ENABLE0_1="Y"
CODEC_PRIORITY0_1="3"
# Disable PCMA
CODEC_ENABLE1_1="N"
# Enable G729A
CODEC_ENABLE3_1="Y"
CODEC_PRIORITY3_1="1"
# Enable PCMU
CODEC_ENABLE4_1="Y"
CODEC_PRIORITY4_1="2"
```

Setting Narrow-band Codecs (PCMA and G.729A)

```
## Codec Settings
# Disable G722
CODEC_ENABLE0_1="N"
# Enable PCMA
CODEC_ENABLE1_1="Y"
CODEC_PRIORITY1_1="1"
# Enable G729A
CODEC_ENABLE3_1="Y"
CODEC_PRIORITY3_1="1"
# Disable PCMU
CODEC_ENABLE4_1="N"
```

Setting the G.729A Codec Only

```
## Codec Settings
# Disable G722
CODEC_ENABLE0_1="N"
# Disable PCMA
CODEC_ENABLE1_1="N"
# Enable G729A
CODEC_ENABLE3_1="Y"
CODEC_PRIORITY3_1="1"
# Disable PCMU
CODEC_ENABLE4_1="N"
```

2.5.2 Example with Incorrect Descriptions

The following listing shows an example of a configuration file that contains incorrect formatting:

- 1 An improper description is entered in the first line. A configuration file must start with the designated character sequence "# Panasonic SIP Phone Standard Format File #".
- 2 Comment lines start in the middle of the lines.

Incorrect Example

```
# This is a simplified sample configuration file. — 1

#####
# Configuration Setting #
#####

CFG_STANDARD_FILE_PATH="http://config.example.com/0123456789AB.cfg"
                        # URL of this configuration file

#####
# SIP Settings #
# Suffix "_1" indicates this parameter is for "line 1". #
#####

SIP_RGSTR_ADDR_1="registrar.example.com" # IP Address or FQDN of SIP registrar server — 2
SIP_PRXY_ADDR_1="proxy.example.com"     # IP Address or FQDN of proxy server
```

Section 3

Phone User Interface Programming

This section explains how to configure the unit by entering direct commands through the phone user interface.





3.1 Phone User Interface Programming

This section provides information about the features that can be configured directly from the unit, but that are not mentioned in the Operating Instructions.





3.1.1 Opening/Closing the Web Port

To access the Web user interface, you must open the unit's Web port beforehand.

To open the unit's Web port

1. In standby mode, tap  or  to select "Basic Settings".
2. Tap "Basic Settings".
3. Tap  or  to select "Other Option".
4. Tap "Other Option".
5. Tap "Embedded Web".
6. Select "On", and then tap "OK".

To close the unit's Web port

1. In standby mode, tap  or  to select "Basic Settings".
2. Tap "Basic Settings".
3. Tap  or  to select "Other Option".
4. Tap "Other Option".
5. Tap "Embedded Web".
6. Select "off", and then tap "OK".

Section 4

Web User Interface Programming

This section provides information about the settings available in the Web user interface.

4.1 Web User Interface Setting List

The following tables show all the settings that you can configure from the Web user interface and the access levels. For details about each setting, see the reference pages listed.

For details about setting up Web user interface programming, see **1.1.6 Web User Interface Programming**.

Status

Menu Item	Section Title	Setting	Access Level ^{*1}		Ref.
			U	A	
Version Information	Version Information	Model	✓	✓	page 58
		IPL Version	✓	✓	page 58
		Firmware Version	✓	✓	page 58
Network Status	Network Common	MAC Address	✓	✓	page 59
		Ethernet Link Status	✓	✓	page 59
		IP Address Mode	✓	✓	page 59
	IPv4	Connection Mode	✓	✓	page 59
		IP Address	✓	✓	page 60
		Subnet Mask	✓	✓	page 60
		Default Gateway	✓	✓	page 60
		DNS1	✓	✓	page 60
		DNS2	✓	✓	page 60
		IPv6	Connection Mode	✓	✓
	IP Address		✓	✓	page 61
	Prefix		✓	✓	page 61
	Default Gateway		✓	✓	page 61
	DNS1		✓	✓	page 61
	DNS2		✓	✓	page 61
	VLAN	Setting Mode	✓	✓	page 61
		LAN Port VLAN ID	✓	✓	page 62
		LAN Port VLAN Priority	✓	✓	page 62
		PC Port VLAN ID	✓	✓	page 62
		PC Port VLAN Priority	✓	✓	page 62
VoIP Status	VoIP Status	Line No.	✓	✓	page 62
		Phone Number	✓	✓	page 62
		VoIP Status	✓	✓	page 63

*1 The access levels are abbreviated as follows:
U: User; A: Administrator

A check mark indicates that the setting is available for that access level.

Network

Menu Item	Section Title	Setting	Access Level ¹		Ref.
			U	A	
Basic Network Settings	IP Addressing Mode	IP Addressing Mode ²		✓	page 64
	IPv4	Connection Mode ²		✓	page 64
		DHCP Host Name ³		✓	page 64
		IP Address ²		✓	page 64
		Subnet Mask ²		✓	page 65
		Default Gateway ²		✓	page 65
		Auto DNS via DHCP ²		✓	page 65
		DNS1 ²		✓	page 65
		DNS2 ²		✓	page 66
	IPv6	Connection Mode ²		✓	page 66
		IP Address ²		✓	page 66
		Prefix ²		✓	page 66
		Default Gateway ²		✓	page 67
		Auto DNS via DHCP ²		✓	page 67
		DNS1 ²		✓	page 67
		DNS2 ²		✓	page 67
Ethernet Port Settings	Link Speed/Duplex Mode	LAN Port ²		✓	page 68
		PC Port ²		✓	page 68
	LLDP	Enable LLDP ²		✓	page 69
		Packet Interval ³		✓	page 69
		PC VLAN ID ²		✓	page 69
		PC Priority ²		✓	page 69
	VLAN	Enable VLAN ²		✓	page 70
		IP Phone VLAN ID ²		✓	page 70
		IP Phone Priority ²		✓	page 70
		PC VLAN ID ²		✓	page 70
		PC Priority ²		✓	page 70
HTTP Client Settings	HTTP Client	HTTP Version ³		✓	page 71
		HTTP User Agent ³		✓	page 71
		Authentication ID ²		✓	page 72
		Authentication Password ²		✓	page 72

4.1 Web User Interface Setting List

Menu Item	Section Title	Setting	Access Level ¹		Ref.
			U	A	
	Proxy Server	Enable Proxy ³		✓	page 72
		Proxy Server Address ³		✓	page 72
		Proxy Server Port ³		✓	page 73
STUN Settings	STUN	Server Address ³		✓	page 73
		Port ³		✓	page 73
		Binding Interval ³		✓	page 74
Multicast Paging Settings	Multicast Paging	Group 1–5	–	–	–
		- IPv4 Address ³		✓	page 74
		- IPv6 Address ³		✓	page 74
		- Port ³		✓	page 75
		- Priority ³ (Group 1–3 only)		✓	page 75
		- Label ³		✓	page 75
		- Enable Transmission ³		✓	page 75
LDAP Settings	LDAP	Enable LDAP ³		✓	page 76
		Server Address ³		✓	page 76
		Port ³		✓	page 76
		User ID ³		✓	page 76
		Password ³		✓	page 77
		Max Hits ³		✓	page 77
		Name Filter ³		✓	page 77
		Number Filter ³		✓	page 77
		Name Attributes ³		✓	page 77
		Number Attributes ³		✓	page 77
		Distinguished Name(Base DN) ²		✓	page 78
		Enable DNS SRV lookup ³		✓	page 78
Xtended Service Settings	Xtended Service	Enable Xtended Service ³		✓	page 78
		Server Address ³		✓	page 78
		Port ³		✓	page 79
		Protocol ³		✓	page 79
		SIP Credentials ³		✓	page 79
	Xtended Service Settings	Line 1–16	–	–	–
		User ID ²		✓	page 80

Menu Item	Section Title	Setting	Access Level ¹		Ref.	
			U	A		
		Password ²		✓	page 80	
		Enable Phonebook ³		✓	page 80	
		Phonebook Type ³		✓	page 80	
		Enable Call Log ³		✓	page 80	
		Enable Visual Voice Mail ³		✓	page 81	
UC Settings	Presence Feature	Enable UC ³		✓	page 81	
		Server Address ³		✓	page 81	
		Local XMPP Port ³		✓	page 82	
		User ID ²		✓	page 82	
		Password ²		✓	page 82	
XML Application Settings	XML Application	Enable XMLAPP ³		✓	page 83	
		User ID ³		✓	page 83	
		Password ³		✓	page 83	
		Local XML Port ³		✓	page 84	
		Bootup URL ³		✓	page 84	
		Initial URL ³		✓	page 84	
		Incoming Call URL ³		✓	page 84	
		Talking URL ³		✓	page 84	
		Making Call URL ³		✓	page 84	
		Call Log URL ³		✓	page 85	
		Idling URL ³		✓	page 85	
		Enable FF Key ³		✓	page 85	
		XML Phonebook	LDAP URL ³		✓	page 85
			User ID ³		✓	page 85
	Password ³			✓	page 86	
	Max Hits ³			✓	page 86	
	ACD Settings	ACD Settings	Line 1–16	–	–	–
			Enable ACD ³		✓	page 86
	Call Center Settings	Call Center Settings	Line 1–16	–	–	–
Enable Call Center ³				✓	page 87	
Disposition Code ³				✓	page 87	
Customer Originated Trace ³				✓	page 88	
Hoteling Event ³				✓	page 88	

4.1 Web User Interface Setting List

Menu Item	Section Title	Setting	Access Level ^{*1}		Ref.
			U	A	
		- User ID ^{*3}		✓	page 88
		- Password ^{*3}		✓	page 88
		Status Event ^{*3}		✓	page 88

*1 The access levels are abbreviated as follows:

U: User; A: Administrator

A check mark indicates that the setting is available for that access level.

*2 This setting can also be configured through other programming methods (phone user interface programming or configuration file programming).

*3 This setting can also be configured through configuration file programming.

System

Menu Item	Section Title	Setting	Access Level ^{*1}		Ref.
			U	A	
Language Settings	Selectable Language	IP Phone ^{*2}		✓	page 89
		Web Language ^{*2}		✓	page 90
	Language Settings	IP Phone ^{*2}	✓	✓	page 91
		Web Language ^{*2}	✓	✓	page 91
User Password Settings	User Password	Current Password	✓	✓	page 92
		New Password ^{*2}	✓	✓	page 92
		Confirm New Password	✓	✓	page 93
Admin Password Settings	Admin Password	Current Password		✓	page 93
		New Password ^{*2}		✓	page 94
		Confirm New Password		✓	page 94

Menu Item	Section Title	Setting	Access Level ¹		Ref.
			U	A	
Time Adjust Settings	Synchronization (Synchronisation)	Server Address ²		✓	page 94
		Synchronization Interval (Synchronisation Interval) ²		✓	page 95
	Time Zone	Time Zone ²		✓	page 95
	Daylight Saving Time (Summer Time)	Enable DST (Enable Summer Time) ²		✓	page 95
		DST Offset (Summer Time Offset) ²		✓	page 95
	Start Day and Time of DST (Start Day and Time of Summer Time)	Month ²		✓	page 95
		Day of Week		✓	page 96
		Time ²		✓	page 97
	End Day and Time of DST (End Day and Time of Summer Time)	Month ²		✓	page 97
		Day of Week		✓	page 97
		Time ²		✓	page 98
	Advanced Settings	IP Phone	Enable Admin Ability ²		✓
Enable IP Phone Lock ²				✓	page 99
Password for Unlocking ²				✓	page 99
Import Display File	Import Display File	File Name	✓	✓	page 99
Wait Time	Wait Time	Wait Time ²	✓	✓	page 100
Communication Camera	Communication Camera Settings [No. 1]–[No. 16]	Phone Number ²		✓	page 101
		Name ²		✓	page 101
		Ringtone [1–32] ²		✓	page 101

¹ The access levels are abbreviated as follows:

U: User; A: Administrator

A check mark indicates that the setting is available for that access level.

² This setting can also be configured through configuration file programming.

VoIP

Menu Item	Section Title	Setting	Access Level ¹		Ref.
			U	A	
SIP Settings	User Agent	User Agent ²		✓	page 102
	NAT Identity	Enable Rport (RFC 3581) ²		✓	page 102
		Enable Port Punching for SIP ²		✓	page 102

4.1 Web User Interface Setting List

Menu Item	Section Title	Setting	Access Level ¹		Ref.
			U	A	
		Enable Port Punching for RTP ²		✓	page 103
SIP Settings [Line 1]–[Line 16]	Basic	Phone Number ²		✓	page 103
		Registrar Server Address ²		✓	page 103
		Registrar Server Port ²		✓	page 104
		Proxy Server Address ²		✓	page 104
		Proxy Server Port ²		✓	page 104
		Presence Server Address ²		✓	page 104
		Presence Server Port ²		✓	page 104
		Outbound Proxy Server Address ²		✓	page 104
		Outbound Proxy Server Port ²		✓	page 105
		Service Domain ²		✓	page 105
		Authentication ID ²		✓	page 105
		Authentication Password ²		✓	page 105
	Advanced	SIP Packet QoS (DSCP) ²		✓	page 105
		Enable DNS SRV lookup ²		✓	page 106
		SRV lookup Prefix for UDP ²		✓	page 106
		SRV lookup Prefix for TCP ²		✓	page 106
		SRV lookup Prefix for TLS ²		✓	page 106
		Local SIP Port ²		✓	page 107
		SIP URI ²		✓	page 107
		T1 Timer ²		✓	page 107
		T2 Timer ²		✓	page 108
		REGISTER Expires Timer ²		✓	page 108
		Enable Session Timer (RFC 4028) ²		✓	page 108
		Session Timer Method ²		✓	page 108
		Enable 100rel (RFC 3262) ²		✓	page 109
		Enable SSAF (SIP Source Address Filter) ²		✓	page 109
		Enable c=0.0.0.0 Hold (RFC 2543) ²		✓	page 109
Transport Protocol ²		✓	page 109		

Menu Item	Section Title	Setting	Access Level ¹		Ref.
			U	A	
		TLS Mode ²		✓	page 110
VoIP Settings	RTP	RTP Packet Time ²		✓	page 111
		Minimum RTP Port Number ²		✓	page 111
		Maximum RTP Port Number ²		✓	page 111
		Telephone-event Payload Type ²		✓	page 111
	Voice Quality Report	Server Address ²		✓	page 111
		Port ²		✓	page 112
		Enable PUBLISH ²		✓	page 112
		Alert Report Trigger ²		✓	page 112
		Threshold MOS-LQ (Critical) ²		✓	page 112
		Threshold MOS-LQ (Warning) ²		✓	page 112
		Threshold Delay (Critical) ²		✓	page 113
	Threshold Delay (Warning) ²		✓	page 113	
	VoIP Settings [Line1]–[Line16]	Basic	G.722	–	–
- Enable ²				✓	page 114
- Priority ²				✓	page 114
PCMA			–	–	–
- Enable ²				✓	page 115
- Priority ²				✓	page 115
G.729A			-	-	-
- Enable ²				✓	page 115
- Priority ²				✓	page 115
PCMU			–	–	–
- Enable ²				✓	page 115
- Priority ²				✓	page 115
DTMF Type			✓	page 116	
Advanced		RTP Packet QoS (DSCP) ²		✓	page 116
		RTCP Packet QoS (DSCP) ²		✓	page 116
		Enable RTCP ²		✓	page 116
	Enable RTCP-XR ²		✓	page 116	
	RTCP&RTCP-XR Interval ²		✓	page 117	
	SRTP Mode ²		✓	page 117	

4.1 Web User Interface Setting List

Menu Item	Section Title	Setting	Access Level ¹		Ref.
			U	A	
		Enable Mixed SRTP & RTP by Conference ²		✓	page 117
		Enable Mixed SRTP & RTP by Transfer ²		✓	page 117

¹ The access levels are abbreviated as follows:

U: User; A: Administrator

A check mark indicates that the setting is available for that access level.

² This setting can also be configured through configuration file programming.

Telephone

Menu Item	Section Title	Setting	Access Level ¹		Ref.
			U	A	
Call Control	Call Control	Send SUBSCRIBE to Voice Mail Server ²		✓	page 118
		Conference Server URI ²		✓	page 118
		First-digit Timeout ²		✓	page 119
		Inter-digit Timeout ²		✓	page 119
		Timer for Dial Plan ²		✓	page 119
		Enable # Key as delimiter ²		✓	page 119
		International Call Prefix ²		✓	page 119
		Country Calling Code ²		✓	page 120
		National Access Code ²		✓	page 120
		Default Line for Outgoing ²	✓	✓	page 120
		Call Park Number ²		✓	page 120
		Enable Call Park Key ²		✓	page 121
		Park Retrieve Number ²		✓	page 121
		Directed Call Pickup ²		✓	page 121
	Emergency Call Phone Numbers	1-5 ²		✓	page 121
	Call Rejection Phone Numbers	1-30 ²	✓	✓	page 121
Call Control [Line 1]–[Line 16]	Call Features	Display Name ²		✓	page 122
		Voice Mail Access Number ²		✓	page 122
		Enable Anonymous Call ⁴	✓	✓	page 123
		Enable Block Anonymous Call ⁴	✓	✓	page 123

Menu Item	Section Title	Setting	Access Level ¹		Ref.
			U	A	
		Enable Do Not Disturb ³	✓	✓	page 123
		Enable Call Waiting ²		✓	page 123
		Enable Call Forwarding Always ³	✓	✓	page 123
		Forwarding Number (Always) ³	✓	✓	page 123
		Enable Call Forwarding Busy ³	✓	✓	page 124
		Forwarding Number (Busy) ³	✓	✓	page 124
		Enable Call Forwarding No Answer ³	✓	✓	page 124
		Forwarding Number (No Answer) ³	✓	✓	page 124
		Ring Counts (No Answer) ³	✓	✓	page 124
		Enable Shared Call ²		✓	page 124
		Enable Key Synchronization (Enable Key Synchronisation) ²		✓	page 125
		Enable Call Park Notification ²		✓	page 125
		Enable Click to Call ²		✓	page 125
		Enable Executive Setting ²		✓	page 125
		Enable Assistant Setting ²		✓	page 126
		MoH Server URI ²		✓	page 126
		Resource List URI ²		✓	page 126
		Dial Plan	Dial Plan (max 1000 columns) ²		✓
Call Even If Dial Plan Does Not Match ²			✓	page 126	
Hotline Settings	Hotline	Enable ²		✓	page 127
		Hotline Number ²	✓	✓	page 128
		Hotline Delay ²		✓	page 128
Flexible Key Settings	Flexible Key Settings	No. 1–24	—	—	—
		Type ²	✓	✓	page 129
		Parameter ²	✓	✓	page 130
		Label Name ²	✓	✓	page 130

4.1 Web User Interface Setting List

Menu Item	Section Title	Setting	Access Level ^{*1}		Ref.
			U	A	
Tone Settings	Dial Tone	Tone Frequencies		✓	page 131
		Tone Timings ^{*2}		✓	page 132
	Busy Tone	Tone Frequencies		✓	page 132
		Tone Timings ^{*2}		✓	page 132
	Ringing Tone	Tone Frequencies		✓	page 133
		Tone Timings ^{*2}		✓	page 133
	Stutter Tone	Tone Frequencies		✓	page 133
		Tone Timings ^{*2}		✓	page 134
Reorder Tone	Tone Frequencies		✓	page 134	
	Tone Timings ^{*2}		✓	page 134	
Import Phonebook	Import Phonebook	File Name	✓	✓	page 136
Export Phonebook	Export Phonebook	—	✓	✓	page 136
Video Call Settings	Default Call Mode	Default Call Mode ^{*4}		✓	page 138
	Screen Mode	Screen Mode ^{*4}		✓	page 139
	Send Image	Send Image at Start ^{*4}		✓	page 139
	Rate Settings	Bit Rate ^{*4}		✓	page 139
		Bit Rate Use ^{*4}		✓	page 139
		Frame Rate ^{*4}		✓	page 140
		Image Size ^{*4}		✓	page 140
DSS Console	DSS 1-5 Key	No. 1–200 ^{*5}	—	—	—
		Type ^{*2}	✓	✓	page 141
		Parameter ^{*2}	✓	✓	page 142
		Label Name ^{*2}	✓	✓	page 142

*1 The access levels are abbreviated as follows:

U: User; A: Administrator

A check mark indicates that the setting is available for that access level.

*2 This setting can also be configured through configuration file programming.

*3 This setting can also be configured through phone user interface programming.

*4 This setting can also be configured through other programming methods (phone user interface programming or configuration file programming).

*5 Each DSS console supports 40 keys. DSS console 1 uses keys 1-40, DSS console 2 uses keys 41-80, etc.

Maintenance

Menu Item	Section Title	Setting	Access Level ^{*1}		Ref.
			U	A	
Provisioning Maintenance	Provisioning Maintenance	Standard File URL ^{*2}		✓	page 143
		Product File URL ^{*2}		✓	page 143
		Master File URL ^{*2}		✓	page 144
		Cyclic Auto Resync ^{*2}		✓	page 144
		Resync Interval ^{*2}		✓	page 144
		Time Resync ^{*2}		✓	page 144
		Header Value for Resync Event ^{*2}		✓	page 144
Firmware Maintenance	Firmware Maintenance	Enable Firmware Update ^{*2}		✓	page 145
		Firmware File URL ^{*2}		✓	page 145
		Firmware Version ^{*2}		✓	page 146
Export Logging File	Export Logging File	Logging File Type		✓	page 146
Reset to Defaults	Reset to Carrier Defaults	The following settings will be reset to carrier default values when you click [Reset to Carrier Defaults] .		✓	page 147
Restart	Restart	Click [Restart] to proceed. Restarting will take a few moments.		✓	page 147

^{*1} The access levels are abbreviated as follows:

U: User; A: Administrator

A check mark indicates that the setting is available for that access level.

^{*2} This setting can also be configured through configuration file programming.

4.2 Status

This section provides detailed descriptions about all the settings classified under the **[Status]** tab.

4.2.1 Version Information

This screen allows you to view the current version information such as the model number and the firmware version of the unit.

4.2.2 Network Status

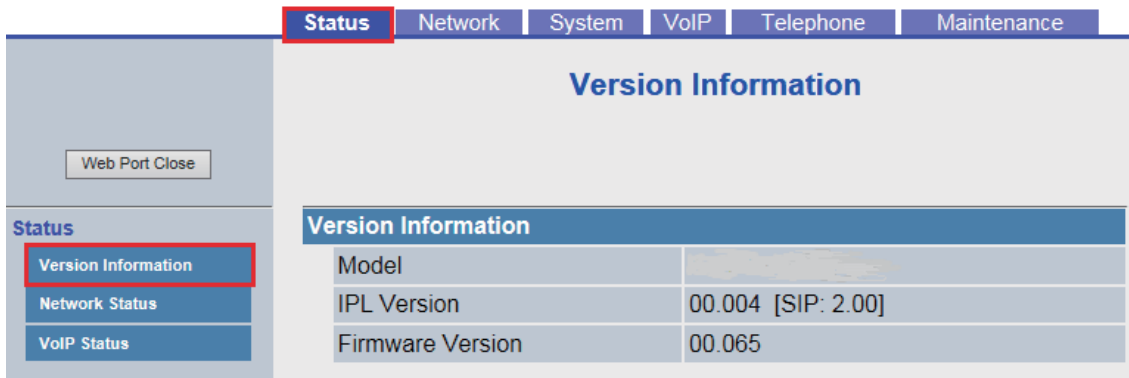

4.2.1.1 Version Information

Model

Description	Indicates the model number of the unit (reference only).
Value Range	Model number

IPL Version

Description	Indicates the version of the IPL (Initial Program Load) that runs when starting the unit and the SIP software version of the unit (reference only).
Value Range	IPL version ("nn.nnn" [n=0–9]) SIP software version ("[SIP: n.nn]" [n=0–9])

Firmware Version

Description	Indicates the version of the firmware that is currently installed on the unit (reference only).
Value Range	Firmware version ("nn.nnn" [n=0–9])

4.2.2 Network Status

This screen allows you to view the current network information of the unit, such as the MAC address, IP address, Ethernet port status, etc.

Clicking **[Refresh]** updates the information displayed on the screen.

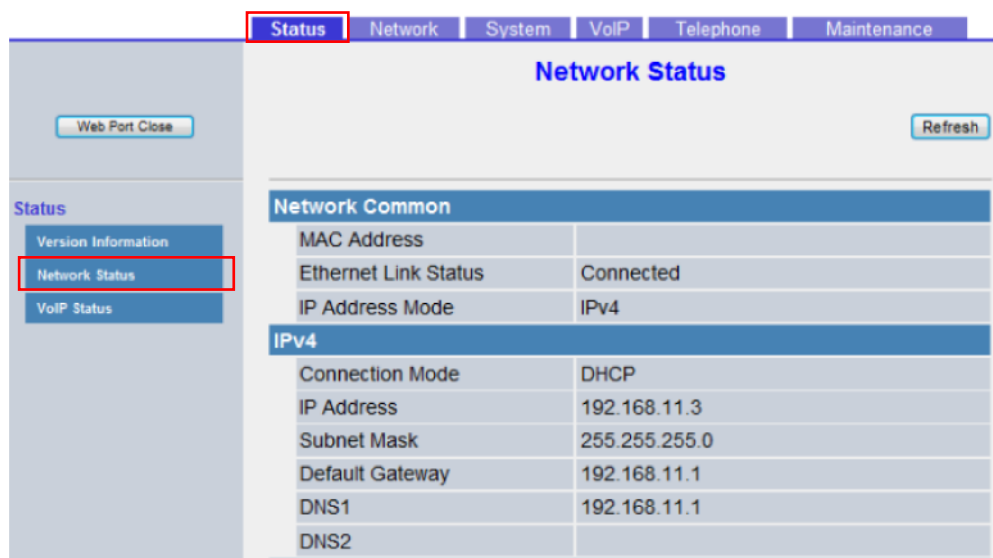

4.2.2.1 Network Common

MAC Address

Description	Indicates the MAC address of the unit (reference only).
Value Range	Not applicable.

Ethernet Link Status

Description	Indicates when either the Ethernet LAN port or the Ethernet PC port is connected (reference only).
Value Range	Connected

IP Address Mode

Description	Indicates the current IP Address Mode.
Value Range	<ul style="list-style-type: none"> • IPv4 • IPv6 • IPv4&IPv6

4.2.2.2 IPv4

Connection Mode

Description	Indicates whether the IP address of the unit is assigned automatically (DHCP) or manually (static) (reference only).
Value Range	<ul style="list-style-type: none"> • DHCP • Static

IP Address

Description	Indicates the currently assigned IP address of the unit (reference only).
Value Range	IP address

Subnet Mask

Description	Indicates the specified subnet mask for the unit (reference only).
Value Range	Subnet mask

Default Gateway

Description	Indicates the specified IP address of the default gateway for the network (reference only). Note <ul style="list-style-type: none"> If the default gateway address is not specified, this field will be left blank.
Value Range	IP address of the default gateway

DNS1

Description	Indicates the specified IP address of the primary DNS server (reference only). Note <ul style="list-style-type: none"> If the primary DNS server address is not specified, this field will be left blank.
Value Range	IP address of the primary DNS server

DNS2

Description	Indicates the specified IP address of the secondary DNS server (reference only). Note <ul style="list-style-type: none"> If the secondary DNS server address is not specified, this field will be left blank.
Value Range	IP address of the secondary DNS server

4.2.2.3 IPv6

Connection Mode

Description	Indicates whether the IP address of the unit is assigned automatically (DHCP) or manually (static) (reference only).
Value Range	<ul style="list-style-type: none"> DHCP Static Stateless Autoconfiguration

IP Address

Description	Indicates the currently assigned IP address of the unit (reference only).
Value Range	IP address

Prefix

Description	Indicates the prefix for IPv6.
Value Range	0–128

Default Gateway

Description	Indicates the specified IP address of the default gateway for the network (reference only). Note <ul style="list-style-type: none"> If the default gateway address is not specified, this field will be left blank.
Value Range	IP address of the default gateway

DNS1

Description	Indicates the specified IP address of the primary DNS server (reference only). Note <ul style="list-style-type: none"> If the primary DNS server address is not specified, this field will be left blank.
Value Range	IP address of the primary DNS server

DNS2

Description	Indicates the specified IP address of the secondary DNS server (reference only). Note <ul style="list-style-type: none"> If the secondary DNS server address is not specified, this field will be left blank.
Value Range	IP address of the secondary DNS server

4.2.2.4 VLAN

Setting Mode

Description	Indicates the specified VLAN feature (reference only).
Value Range	<ul style="list-style-type: none"> Disable LLDP Manual

4.2.3 VoIP Status

LAN Port VLAN ID

Description	Indicates the VLAN ID (reference only) for the IP Phone.
Value Range	0–4094

LAN Port VLAN Priority

Description	Indicates the priority number (reference only) for the IP Phone.
Value Range	0–7

PC Port VLAN ID

Description	Indicates the VLAN ID (reference only) for the PC.
Value Range	0–4094

PC Port VLAN Priority

Description	Indicates the priority number (reference only) for the PC.
Value Range	0–7

4.2.3 VoIP Status

This screen allows you to view the current VoIP status of each line's unit. Clicking **[Refresh]** updates the information displayed on the screen.

Line No.	Phone Number	VoIP Status
1	1000	Registered
2	2000	Registering

4.2.3.1 VoIP Status

Line No.(1–16)

Description	Indicates the line number to which a phone number is assigned (reference only).
Value Range	Line 1–Line 16

Phone Number

Description	Indicates the currently assigned phone numbers (reference only). Note <ul style="list-style-type: none">The corresponding field is blank if a line has not yet been leased or if the unit has not been configured.
Value Range	Max. 32 digits

VoIP Status

Description	Indicates the current VoIP status of each line (reference only).
Value Range	<ul style="list-style-type: none"> Registered: The unit has been registered to the SIP server, and the line can be used. Registering: The unit is being registered to the SIP server, and the line cannot be used. Blank: The line has not been leased, the unit has not been configured yet, or a SIP authentication failure has occurred. <p>Note</p> <ul style="list-style-type: none"> Immediately after starting up the unit, the phone numbers of the lines will be displayed, but the status of the line may not be displayed because the unit is still being registered to the SIP server. To display the status, wait about 30 to 60 seconds, and then click [Refresh] to obtain updated status information.

4.3 Network

This section provides detailed descriptions about all the settings classified under the **[Network]** tab.

4.3.1 Basic Network Settings

This screen allows you to change basic network settings such as whether to use a DHCP server, and the IP address of the unit.

Note

- Changes to the settings on this screen are applied when the message "Complete" appears after clicking **[Save]**. Because the IP address of the unit will probably be changed if you change these settings, you will not be able to continue using the Web user interface. To continue configuring the unit from the Web user interface, log in to the Web user interface again after confirming the newly assigned IP address of the unit using the phone user interface. In addition, if the IP address of the PC from which you try to access the Web user interface has been changed, close the Web port once by selecting "Off" for "Embedded Web" on the unit (→ see **Opening/Closing the Web Port** in **1.1.6.3 Before Accessing the Web User Interface**).

The screenshot shows the 'Basic Network Settings' page. At the top, there are tabs for Status, Network (highlighted), System, VoIP, Telephone, and Maintenance. Below the tabs is a 'Web Port Close' button. On the left, a sidebar lists network-related settings: Basic Network Settings (highlighted), Ethernet Port Settings, HTTP Client Settings, STUN Settings, Multicast Paging Settings, and LDAP Settings. The main content area is titled 'Basic Network Settings' and contains the following configuration options:

- IP Addressing Mode:** IP Addressing Mode is set to IPv4, IPv6, or IPv4 & IPv6.
- IPv4:**
 - Connection Mode: DHCP, Static
 - DHCP Host Name: {MODEL}
 - IP Address: 192.168.0.154
 - Subnet Mask: 255.255.255.0

4.3.1.1 IP Addressing Mode

IP Addressing Mode

Description	Selects the IP addressing mode.
Value Range	<ul style="list-style-type: none"> • IPv4 • IPv6 • IPv4&IPv6
Default Value	IPv4
Configuration File Reference	IP_ADDR_MODE

4.3.1.2 IPv4

Connection Mode

Description	Selects the IP address setting mode for IPv4.
Value Range	<ul style="list-style-type: none"> • DHCP • Static
Default Value	DHCP
Configuration File Reference	CONNECTION_TYPE

DHCP Host Name

Description	<p>Specifies the host name to option12 in DHCPv4 or option15 in DHCPv6.</p> <p>Note</p> <ul style="list-style-type: none"> • This setting is available only when [Connection Mode] is set to [DHCP].
Value Range	<p>Max. 64 characters</p> <p>Note</p> <ul style="list-style-type: none"> • If "{MODEL}" is included in this parameter, it will be replaced with the unit's model name.
Default Value	{MODEL}
Configuration File Reference	DHCP_HOST_NAME

IP Address

Description	<p>Specifies the IP address for IPv4.</p> <p>Note</p> <ul style="list-style-type: none"> • This setting is available only when [Connection Mode] is set to [Static].
Value Range	<p>Max. 15 characters</p> <p>n.n.n.n [n=0–255]</p>
Default Value	Not stored.

Configuration File Reference	STATIC_IP_ADDRESS
------------------------------	-------------------

Subnet Mask

Description	Specifies the subnet mask for IPv4. Note <ul style="list-style-type: none"> This setting is available only when [Connection Mode] is set to [Static].
Value Range	Max. 15 characters n.n.n.n [n=0–255]
Default Value	Not stored.
Configuration File Reference	STATIC_SUBNET

Default Gateway

Description	Specifies the default gateway for IPv4. Note <ul style="list-style-type: none"> This setting is available only when [Connection Mode] is set to [Static].
Value Range	Max. 15 characters n.n.n.n [n=0–255]
Default Value	Not stored.
Configuration File Reference	STATIC_GATEWAY

Auto DNS via DHCP

Description	Selects whether to enable or disable the DNS server obtained by DHCPv4. Note <ul style="list-style-type: none"> This setting is available only when [Connection Mode] is set to [DHCP].
Value Range	<ul style="list-style-type: none"> Yes: Use DNS obtained by DHCPv4 No: Not use (use static DNS)
Default Value	Yes
Configuration File Reference	DHCP_DNS_ENABLE

DNS1

Description	Specifies the IP address of primary DNS server for IPv4.
Value Range	Max. 15 characters n.n.n.n [n=0–255]
Default Value	Not stored.
Configuration File Reference	USER_DNS1_ADDR

DNS2

Description	Specifies the IP address of secondary DNS server for IPv4.
Value Range	Max. 15 characters n.n.n.n [n=0–255]
Default Value	Not stored.
Configuration File Reference	USER_DNS2_ADDR

4.3.1.3 IPv6

Connection Mode

Description	Selects the IP address setting mode for IPv6.
Value Range	<ul style="list-style-type: none"> • DHCP • Static • Stateless Autoconfiguration
Default Value	DHCP
Configuration File Reference	CONNECTION_TYPE_IPV6

IP Address

Description	<p>Specifies the IP address for IPv6.</p> <p>Note</p> <ul style="list-style-type: none"> • This setting is available only when [Connection Mode] is set to [Static].
Value Range	Max. 39 characters n:n:n:n:n:n [n=0-FFFF, abbreviation available]
Default Value	Not stored.
Configuration File Reference	STATIC_IP_ADDRESS_IPV6

Prefix

Description	<p>Specifies the prefix for IPv6.</p> <p>Note</p> <ul style="list-style-type: none"> • This setting is available only when [Connection Mode] is set to [Static].
Value Range	0–128
Default Value	64
Configuration File Reference	PREFIX_IPV6

Default Gateway

Description	Specifies the default gateway for IPv6. Note <ul style="list-style-type: none"> This setting is available only when [Connection Mode] is set to [Static].
Value Range	Max. 39 characters n:n:n:n:n:n:n [n=0-FFFF, abbreviation available]
Default Value	Not stored.
Configuration File Reference	STATIC_GATEWAY_IPV6

Auto DNS via DHCP

Description	Selects whether to enable or disable the DNS server obtained by DHCPv6. Note <ul style="list-style-type: none"> This setting is available only when [Connection Mode] is set to [DHCP].
Value Range	<ul style="list-style-type: none"> Yes: Use DNS obtained by DHCPv6 No: Not use (use static DNS)
Default Value	Yes
Configuration File Reference	DHCP_DNS_ENABLE_IPV6

DNS1

Description	Specifies the IP address of primary DNS server for IPv6.
Value Range	Max. 39 characters n:n:n:n:n:n:n [n=0-FFFF, abbreviation available]
Default Value	Not stored.
Configuration File Reference	USER_DNS1_ADDR_IPV6

DNS2

Description	Specifies the IP address of secondary DNS server for IPv6.
Value Range	Max. 39 characters n:n:n:n:n:n:n [n=0-FFFF, abbreviation available]
Default Value	Not stored.
Configuration File Reference	USER_DNS2_ADDR_IPV6

4.3.2 Ethernet Port Settings

This screen allows you to change the connection mode of the Ethernet ports, LLDP and the VLAN settings.

4.3.2 Ethernet Port Settings

Note

- When you change the settings on this screen and click **[Save]**, after the message "Complete" has been displayed, the unit will restart automatically with the new settings applied. If a unit is on a call when "Complete" has been displayed, the unit will restart after the unit returns to idle.

The screenshot shows the 'Ethernet Port Settings' configuration page. The 'Network' tab is active. The 'Ethernet Port Settings' menu item is highlighted. The 'Link Speed/Duplex Mode' section shows 'LAN Port' and 'PC Port' both set to 'Auto Negotiation'. The 'LLDP' section shows 'Enable LLDP' set to 'Yes', 'Packet Interval' set to '30 seconds', and 'PC' settings for 'VLAN ID' (0) and 'Priority' (0). The 'VLAN' section shows 'Enable VLAN' set to 'No'.

4.3.2.1 Link Speed/Duplex Mode

LAN Port

Description	Selects the connection mode (link speed and duplex mode) of the LAN port.
Value Range	<ul style="list-style-type: none"> Auto Negotiation 100Mbps/Full Duplex 100Mbps/Half Duplex 10Mbps/Full Duplex 10Mbps/Half Duplex
Default Value	Auto Negotiation
Configuration File Reference	PHY_MODE_LAN

PC Port

Description	Selects the connection mode (link speed and duplex mode) of the PC port.
Value Range	<ul style="list-style-type: none"> Auto Negotiation 100Mbps/Full Duplex 100Mbps/Half Duplex 10Mbps/Full Duplex 10Mbps/Half Duplex
Default Value	Auto Negotiation

Configuration File Reference	PHY_MODE_PC
------------------------------	-------------

4.3.2.2 LLDP

Enable LLDP

Description	Selects whether to enable or disable the LLDP-MED feature. Note <ul style="list-style-type: none"> You should specify "Yes" for only one of "Enable LLDP", or "Enable VLAN". If "Yes" is specified for two or more of the parameters above, the settings are prioritized as follows: "Enable VLAN" > "Enable LLDP". Therefore, if "Yes" is specified for both "Enable VLAN" and "Enable LLDP", the VLAN-related settings are used.
Value Range	<ul style="list-style-type: none"> Yes No
Default Value	Yes
Configuration File Reference	LLDP_ENABLE

Packet Interval

Description	Specifies the interval, in seconds, between sending each LLDP frame.
Value Range	1–3600
Default Value	30
Configuration File Reference	LLDP_INTERVAL

PC VLAN ID

Description	Specifies the VLAN ID for the PC when LLDP is on.
Value Range	0–4094
Default Value	0
Configuration File Reference	LLDP_VLAN_ID_PC

PC Priority

Description	Specifies the VLAN Priority for the PC when LLDP is on.
Value Range	0–7
Default Value	0
Configuration File Reference	LLDP_VLAN_PRI_PC

4.3.2.3 VLAN

Enable VLAN

Description	Selects whether to use the VLAN feature to perform VoIP communication securely. Note <ul style="list-style-type: none"> You should specify "Yes" for only one of "Enable LLDP", or "Enable VLAN". If "Yes" is specified for two or more of the parameters above, the settings are prioritized as follows: "Enable VLAN" > "Enable LLDP". Therefore, if "Yes" is specified for both "Enable VLAN" and "Enable LLDP", the VLAN-related settings are used.
Value Range	<ul style="list-style-type: none"> Yes No
Default Value	No
Configuration File Reference	VLAN_ENABLE

IP Phone VLAN ID

Description	Specifies the VLAN ID for the IP Phone.
Value Range	0–4094
Default Value	2
Configuration File Reference	VLAN_ID_IP_PHONE

IP Phone Priority

Description	Selects the priority for the IP Phone.
Value Range	0–7
Default Value	7
Configuration File Reference	VLAN_PRI_IP_PHONE

PC VLAN ID

Description	Specifies the VLAN ID for the PC.
Value Range	0–4094
Default Value	1
Configuration File Reference	VLAN_ID_PC

PC Priority

Description	Selects the priority for the PC.
Value Range	0–7
Default Value	0

Configuration File Reference	VLAN_PRI_PC
------------------------------	-------------

4.3.3 HTTP Client Settings

This screen allows you to change the HTTP client settings for the unit in order to access the HTTP server of your phone system and download configuration files.

4.3.3.1 HTTP Client

HTTP Version

Description	Selects which version of the HTTP protocol to use for HTTP communication.
Value Range	<ul style="list-style-type: none"> • HTTP/1.0 • HTTP/1.1 <p>Note</p> <ul style="list-style-type: none"> • For this unit, it is strongly recommended that you select [HTTP/1.0]. However, if the HTTP server does not function well with HTTP/1.0, try changing the setting [HTTP/1.1].
Default Value	HTTP/1.0
Configuration File Reference	HTTP_VER

HTTP User Agent

Description	Specifies the text string to send as the user agent in the header of HTTP requests.
--------------------	---

4.3.3 HTTP Client Settings

Value Range	Max. 64 characters Note <ul style="list-style-type: none">• If "{mac}" is included in this parameter, it will be replaced with the unit's MAC address in lower-case.• If "{MAC}" is included in this parameter, it will be replaced with the unit's MAC address in upper-case.• If "{MODEL}" is included in this parameter, it will be replaced with the unit's model name.• If "{fwver}" is included in this parameter, it will be replaced with the firmware version of the unit.
Default Value	Panasonic_{MODEL}/{fwver} {mac}
Configuration File Reference	HTTP_USER_AGENT

Authentication ID

Description	Specifies the ID for the User account. If set, this name must be entered to access the Web user interface at the User access level.
Value Range	Max. 128 characters
Default Value	Not stored.
Configuration File Reference	HTTP_AUTH_ID

Authentication Password

Description	Specifies the password for the User account. If set, this password must be entered to access the Web user interface at the User access level.
Value Range	Max. 128 characters
Default Value	Not stored.
Configuration File Reference	HTTP_AUTH_PASS

4.3.3.2 Proxy Server

Enable Proxy

Description	Selects whether to enable or disable the HTTP proxy feature.
Value Range	<ul style="list-style-type: none">• Yes• No
Default Value	No
Configuration File Reference	HTTP_PROXY_ENABLE

Proxy Server Address

Description	Specifies the IP address or FQDN of the proxy server.
Value Range	Max. 256 characters
Default Value	Not stored.

Configuration File Reference	HTTP_PROXY_ADDR
-------------------------------------	-----------------

Proxy Server Port

Description	Specifies the port number of the proxy server.
Value Range	1–65535
Default Value	8080
Configuration File Reference	HTTP_PROXY_PORT

4.3.4 STUN Settings

This screen allows you to change the STUN Settings.

4.3.4.1 STUN

STUN: Simple Traversal of UDP through NATs

Server Address

Description	Specifies the host name or IP address of the STUN server for the CPE to send Binding Requests.
Value Range	Max. 256 characters
Default Value	Not stored.
Configuration File Reference	STUN_SERV_ADDR

Port

Description	Specifies the port number of the STUN server for the CPE to send Binding Requests.
Value Range	1–65535
Default Value	3478
Configuration File Reference	STUN_SERV_PORT

4.3.5 Multicast Paging Settings

Binding Interval

Description	Specifies the interval of the sending binding request.
Value Range	60–86400
Default Value	300
Configuration File Reference	STUN_INTVL

4.3.5 Multicast Paging Settings

This screen allows you to change the Multicast Paging Settings for each channel Group.

The screenshot shows the 'Multicast Paging Settings' page. At the top, there are tabs for 'Status', 'Network', 'System', 'VoIP', 'Telephone', and 'Maintenance'. The 'Network' tab is active. On the left, a sidebar menu lists various settings, with 'Multicast Paging Settings' highlighted. The main area is titled 'Multicast Paging Settings' and shows configuration for 'Group 5'. The settings include:

- IPv4 Address: [224.0.0.0-239.255.255.255]
- IPv6 Address: [FF00::/8]
- Port: 0 [0-65535, 0:Disable]
- Label: []
- Enable Transmission: Yes No

4.3.5.1 Multicast Paging

IPv4 Address (Group 1–5)

Description	Specifies the address for multi-cast paging for each channel group. {Priority: Group 5 > Group 4 > Group 3, Group2, Group1 (depending on the configuration)}
Value Range	224.0.0.0–239.255.255.255
Default Value	Not stored.
Configuration File Reference	MPAGE_ADDRm

IPv6 Address (Group 1–5)

Description	Specifies the IPv6 address for multi-cast paging for each channel group. {Priority: Group 5 > Group 4 > Group 3, Group2, Group1 (depending on the configuration)}
Value Range	FF00::/8
Default Value	Not stored.
Configuration File Reference	MPAGE_IPV6_ADDRm

Port (Group 1–5)

Description	Specifies the port number for multi-cast paging for each channel group.
Value Range	0–65535 0: Disable
Default Value	0
Configuration File Reference	MPAGE_PORTm

Priority (Group 1–3)

Description	Selects the priority of the low priority channel group. The priority of multi-cast paging group1-3 is lower than the talking. Priority 4 is higher than Priority 5.
Value Range	4, 5
Default Value	5
Configuration File Reference	MPAGE_PRIORITYm

Label (Group 1–5)

Description	Specifies a label for each channel group.
Value Range	Max. 24 characters
Default Value	Not stored.
Configuration File Reference	MPAGE_LABELm

Enable Transmission (Group 1–5)

Description	Selects the sending multi-cast paging.
Value Range	<ul style="list-style-type: none"> • Yes • No
Default Value	No
Configuration File Reference	MPAGE_SEND_ENABLEm

4.3.6 LDAP Settings

This screen allows you to change the LDAP Settings.

4.3.6 LDAP Settings

The screenshot shows a web-based configuration interface with a top navigation bar containing 'Status', 'Network', 'System', 'VoIP', 'Telephone', and 'Maintenance'. The 'Network' tab is selected. On the left, a sidebar lists various network settings, with 'LDAP Settings' highlighted in red. The main content area is titled 'LDAP Settings' and contains a form with the following fields:

LDAP	
Enable LDAP	<input type="radio"/> Yes <input checked="" type="radio"/> No
Server Address	<input type="text"/>
Port	<input type="text" value="389"/> [1-65535]
User ID	<input type="text"/>
Password	<input type="password"/>
Max Hits	<input type="text" value="20"/> [20-500]

4.3.6.1 LDAP

Enable LDAP

Description	Selects whether to enable or disable the LDAP service.
Value Range	<ul style="list-style-type: none">• Yes• No
Default Value	No
Configuration File Reference	LDAP_ENABLE

Server Address

Description	Specifies the server host of LDAP.
Value Range	Max. 256 characters
Default Value	Not stored.
Configuration File Reference	LDAP_SERVER

Port

Description	Specifies the port of server.
Value Range	1–65535
Default Value	389
Configuration File Reference	LDAP_SERVER_PORT

User ID

Description	Specifies the authentication ID required to access the LDAP server.
Value Range	Max. 128 characters
Default Value	Not stored.
Configuration File Reference	LDAP_USERID

Password

Description	Specifies the authentication password required to access the LDAP server.
Value Range	Max. 128 characters
Default Value	Not stored.
Configuration File Reference	LDAP_PASSWORD

Max Hits

Description	Specifies the maximum number of search results to be returned by the LDAP server.
Value Range	20–500
Default Value	20
Configuration File Reference	LDAP_MAXRECORD

Name Filter

Description	Specifies the name filter which is the search criteria for name look up.
Value Range	Max. 256 characters
Default Value	((cn=%)(sn=%))
Configuration File Reference	LDAP_NAME_FILTER

Number Filter

Description	Specifies the number filter which is the search criteria for number look up.
Value Range	Max. 256 characters
Default Value	((telephoneNumber=%)(mobile=%)(homePhone=%))
Configuration File Reference	LDAP_NUMB_FILTER

Name Attributes

Description	Specifies the name attributes of each record which are to be returned in the LDAP search result.
Value Range	Max. 256 characters
Default Value	cn,sn
Configuration File Reference	LDAP_NAME_ATTRIBUTE

Number Attributes

Description	Specifies the number attributes of each record which are to be returned in the LDAP search result.
Value Range	Max. 256 characters
Default Value	telephoneNumber,mobile,homePhone
Configuration File Reference	LDAP_NUMB_ATTRIBUTE

Distinguished Name(Base DN)

Description	Specifies the entry information on the screen.
Value Range	Max. 256 characters
Default Value	Not stored.
Configuration File Reference	LDAP_BASEDN

Enable DNS SRV lookup

Description	Selects whether to request the DNS server to translate domain names into IP addresses using the SRV record.
Value Range	<ul style="list-style-type: none"> • Yes • No
Default Value	No
Configuration File Reference	LDAP_DNSSRV_ENABLE

4.3.7 Xtended Service Settings

This screen allows you to change the Xtended Service Settings.

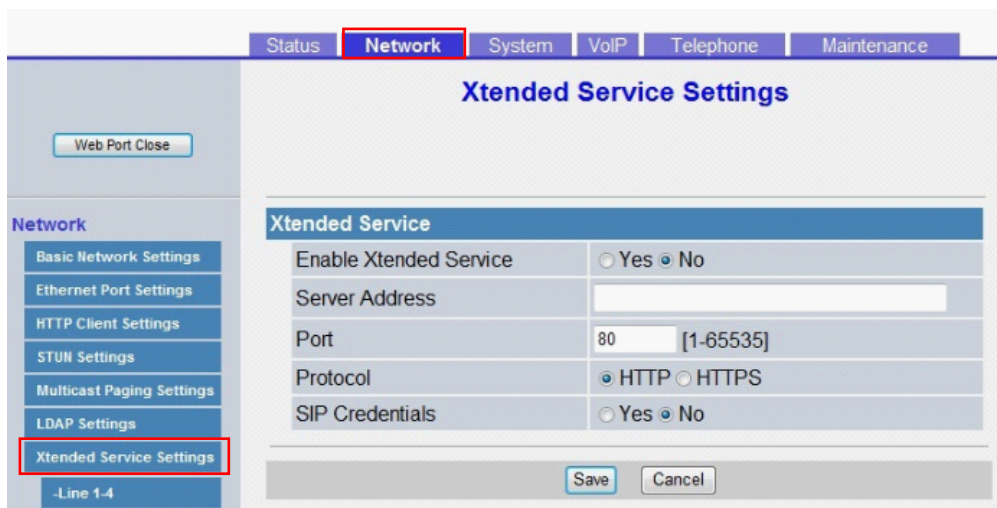

4.3.7.1 Xtended Service

Enable Xtended Service

Description	Selects whether to enable or disable the Xsi service.
Value Range	<ul style="list-style-type: none"> • Yes • No
Default Value	No
Configuration File Reference	XSI_ENABLE

Server Address

Description	Specifies the IP address or FQDN of the Xsi server.
--------------------	---

Value Range	Max. 256 characters
Default Value	Not stored.
Configuration File Reference	XSI_SERVER

Port

Description	Specifies the port of the Xsi server.
Value Range	1–65535
Default Value	80
Configuration File Reference	XSI_SERVER_PORT

Protocol

Description	Selects the type of the Xsi server.
Value Range	HTTP, HTTPS
Default Value	HTTP
Configuration File Reference	XSI_SERVER_TYPE

SIP Credentials

Description	Selects whether to enable or disable the XSI SIP Credentials feature.
Value Range	<ul style="list-style-type: none"> • Yes • No
Default Value	No
Configuration File Reference	XSI_SIP_CREDENTIALS_ENABLE

4.3.7.2 Xtended Service Settings [Line 1]–[Line 16]

The screenshot shows a web-based configuration interface. At the top, there are tabs for Status, Network (highlighted in red), System, VoIP, Telephone, and Maintenance. Below the tabs, there is a section titled "Xtended Service Settings [Line 1 - 4]". On the left side, there is a sidebar menu with "Network" selected, and "Xtended Service Settings" is highlighted in red. The main content area shows the configuration for "Line 1". It includes fields for "User ID" and "Password" (masked with dots), and radio buttons for "Enable Phonebook" (set to No), "Enable Call Log" (set to No), and "Enable Visual Voice Mail" (set to No). A dropdown menu for "Phonebook Type" is set to "Group". Below this, there is another "User ID" field for a second line.

User ID

Description	Specifies the authentication ID required to access the Xsi server.
Value Range	Max. 128 characters
Default Value	Not stored.
Configuration File Reference	XSI_USERID_n

Password

Description	Specifies the authentication password required to access the Xsi server.
Value Range	Max. 128 characters
Default Value	Not stored.
Configuration File Reference	XSI_PASSWORD_n

Enable Phonebook

Description	Selects whether to enable or disable the Xsi phonebook service.
Value Range	<ul style="list-style-type: none"> • Yes • No
Default Value	No
Configuration File Reference	XSI_PHONEBOOK_ENABLE_n

Phonebook Type

Description	Selects the type of Xsi phonebook.
Value Range	<ul style="list-style-type: none"> • Group • GroupCommon • Enterprise • EnterpriseCommon • Personal
Default Value	Group
Configuration File Reference	XSI_PHONEBOOK_TYPE_n

Enable Call Log

Description	Selects whether to enable or disable the Xsi call log service.
Value Range	<ul style="list-style-type: none"> • Yes • No
Default Value	No
Configuration File Reference	XSI_CALLLOG_ENABLE_n

Enable Visual Voice Mail

Description	Selects whether to enable or disable the Visual Voice Mail feature of the selected line.
Value Range	<ul style="list-style-type: none"> • Yes • No
Default Value	No
Configuration File Reference	XSI_VISUAL_VM_ENABLE_n

4.3.8 UC Settings

This screen allows you to change the UC Settings.

The screenshot shows a web interface with a top navigation bar containing tabs: Status, Network (highlighted), System, VoIP, Telephone, and Maintenance. Below the navigation bar is a sidebar with a 'Web Port Close' button and a 'Network' section containing various settings categories. The 'UC Settings' category is highlighted with a red box. The main content area is titled 'UC Settings' and contains a 'Presence Feature' section. This section includes a radio button for 'Enable UC' (set to 'No'), a text input for 'Server Address', a text input for 'Local XMPP Port' with the value '5222' and a range '[1-65535]', a text input for 'User ID', and a password field. At the bottom of the section are 'Save' and 'Cancel' buttons.

4.3.8.1 Presence Feature

Enable UC

Description	Selects whether to enable the UC service.
Value Range	<ul style="list-style-type: none"> • Yes • No
Default Value	No
Configuration File Reference	UC_ENABLE

Server Address

Description	Specifies the IP address or FQDN of the XMPP server.
--------------------	--

4.3.9 XML Application Settings

Value Range	Max. 256 characters
Default Value	Not stored.
Configuration File Reference	XMPP_SERVER

Local XMPP Port

Description	Specifies the local XMPP port.
Value Range	1–65535
Default Value	5222
Configuration File Reference	XMPP_PORT

User ID

Description	Specifies the authentication ID required to access the UC server.
Value Range	Max. 128 characters
Default Value	Not stored.
Configuration File Reference	UC_USERID

Password

Description	Specifies the authentication password required to access the UC server.
Value Range	Max. 128 characters
Default Value	Not stored.
Configuration File Reference	UC_PASSWORD

4.3.9 XML Application Settings

This screen allows you to configure the various URLs used with the XML application feature.

The screenshot shows the 'XML Application Settings' page. At the top, there are navigation tabs: Status, Network (highlighted), System, VoIP, Telephone, and Maintenance. Below the tabs is a 'Web Port Close' button. On the left, a 'Network' sidebar contains several sub-menus, with 'XML Application Settings' highlighted. The main content area is titled 'XML Application' and contains the following settings:

XML Application	
Enable XMLAPP	<input type="radio"/> Yes <input checked="" type="radio"/> No
User ID	<input type="text"/>
Password	<input type="password"/>
Local XML Port	<input type="text" value="6666"/> [1-65535]
Bootup URL	<input type="text"/>
Initial URL	<input type="text"/>
Incoming Call URL	<input type="text"/>
Talking URL	<input type="text"/>
Making Call URL	<input type="text"/>
Call Log URL	<input type="text"/>
Idling URL	<input type="text"/>
Enable FF Key	<input type="radio"/> Yes <input checked="" type="radio"/> No

4.3.9.1 XML Application

Enable XMLAPP

Description	Selects whether to enable or disable the XML application feature.
Value Range	<ul style="list-style-type: none"> • Yes • No
Default Value	No
Configuration File Reference	XMLAPP_ENABLE

User ID

Description	Specifies the authentication ID required to access the XML application server.
Value Range	Max. 128 characters
Default Value	Not stored.
Configuration File Reference	XMLAPP_USERID

Password

Description	Specifies the authentication password used to access the XML application server.
Value Range	Max. 128 characters
Default Value	Not stored.

4.3.9 XML Application Settings

Configuration File Reference	XMLAPP_USERPASS
-------------------------------------	-----------------

Local XML Port

Description	Specifies the local HTTP port for XML application.
Value Range	1–65535
Default Value	6666
Configuration File Reference	XML_HTTPD_PORT

Bootup URL

Description	Specifies the URL that is accessed when the unit starts up, to check for XML data.
Value Range	Max. 256 characters
Default Value	Not stored.
Configuration File Reference	XMLAPP_START_URL

Initial URL

Description	Specifies the URL that is accessed when the application is started from the unit's menu, to check for XML data.
Value Range	Max. 256 characters
Default Value	Not stored.
Configuration File Reference	XMLAPP_INITIAL_URL

Incoming Call URL

Description	Specifies the URL that is accessed when the unit receives a call, to check for XML data.
Value Range	Max. 256 characters
Default Value	Not stored.
Configuration File Reference	XMLAPP_INCOMING_URL

Talking URL

Description	Specifies the URL that is accessed when the unit is on a call, to check for XML data.
Value Range	Max. 256 characters
Default Value	Not stored.
Configuration File Reference	XMLAPP_TALKING_URL

Making Call URL

Description	Specifies the URL that is accessed when the unit makes a call, to check for XML data.
Value Range	Max. 256 characters
Default Value	Not stored.

Configuration File Reference	XMLAPP_MAKECALL_URL
-------------------------------------	---------------------

Call Log URL

Description	Specifies the URL that is accessed when the call log is accessed, to check for XML data.
Value Range	Max. 256 characters
Default Value	Not stored.
Configuration File Reference	XMLAPP_CALLLOG_URL

Idling URL

Description	Specifies the URL that is accessed when the unit is idle, to check for XML data.
Value Range	Max. 256 characters
Default Value	Not stored.
Configuration File Reference	XMLAPP_IDLING_URL

Enable FF Key

Description	Specifies whether to enable the XML application or operate the telephone normally, when the corresponding button is pressed.
Value Range	<ul style="list-style-type: none"> • Yes • No
Default Value	No
Configuration File Reference	XMLAPP_FFKEY_ENABLE

4.3.9.2 XML Phonebook

LDAP URL

Description	Specifies the URL that is accessed when the phonebook is accessed, to check for XML data.
Value Range	Max. 256 characters
Default Value	Not stored.
Configuration File Reference	XMLAPP_LDAP_URL

User ID

Description	Specifies the authentication ID required to access the LDAP server.
Value Range	Max. 128 characters
Default Value	Not stored.
Configuration File Reference	XMLAPP_LDAP_USERID

4.3.10 ACD Settings [Line1]–[Line16]

Password

Description	Specifies the authentication password used to access the LDAP server.
Value Range	Max. 128 characters
Default Value	Not stored.
Configuration File Reference	XMLAPP_LDAP_USERPASS

Max Hits

Description	Specifies the maximum number of search results to be returned by the LDAP server.
Value Range	20–500
Default Value	20
Configuration File Reference	XMLAPP_LDAP_MAXRECORD

4.3.10 ACD Settings [Line1]–[Line16]

The screenshot shows a web interface with a navigation bar at the top containing tabs: Status, Network (highlighted), System, VoIP, Telephone, and Maintenance. Below the navigation bar is a header for 'ACD Settings'. On the left, there is a sidebar menu with categories: Network, UC Settings, and XML Application Settings. Under 'Network', several sub-items are listed, with 'ACD Settings' highlighted. The main content area contains a table titled 'ACD Settings' with 14 rows, one for each line (Line 1 to Line 14). Each row has three columns: 'Line', 'Enable ACD', and a radio button selection between 'Yes' and 'No'. In all rows, the 'No' radio button is selected.

Line	Enable ACD	Selection
Line 1	Enable ACD	<input type="radio"/> Yes <input checked="" type="radio"/> No
Line 2	Enable ACD	<input type="radio"/> Yes <input checked="" type="radio"/> No
Line 3	Enable ACD	<input type="radio"/> Yes <input checked="" type="radio"/> No
Line 4	Enable ACD	<input type="radio"/> Yes <input checked="" type="radio"/> No
Line 5	Enable ACD	<input type="radio"/> Yes <input checked="" type="radio"/> No
Line 6	Enable ACD	<input type="radio"/> Yes <input checked="" type="radio"/> No
Line 7	Enable ACD	<input type="radio"/> Yes <input checked="" type="radio"/> No
Line 8	Enable ACD	<input type="radio"/> Yes <input checked="" type="radio"/> No
Line 9	Enable ACD	<input type="radio"/> Yes <input checked="" type="radio"/> No
Line 10	Enable ACD	<input type="radio"/> Yes <input checked="" type="radio"/> No
Line 11	Enable ACD	<input type="radio"/> Yes <input checked="" type="radio"/> No
Line 12	Enable ACD	<input type="radio"/> Yes <input checked="" type="radio"/> No
Line 13	Enable ACD	<input type="radio"/> Yes <input checked="" type="radio"/> No
Line 14	Enable ACD	<input type="radio"/> Yes <input checked="" type="radio"/> No

Enable ACD

Description	Selects whether to enable the ACD.
Value Range	<ul style="list-style-type: none"> • Yes • No

Default Value	No
Configuration File Reference	ACD_ENABLE_n

4.3.11 Call Center Settings [Line1]–[Line16]

Status **Network** System VoIP Telephone Maintenance

Call Center Settings [Line 1 - 4]

Web Port Close

Network

- Basic Network Settings
- Ethernet Port Settings
- HTTP Client Settings
- STUN Settings
- Multicast Paging Settings
- LDAP Settings
- Extended Service Settings
- Line 1-4
- Line 5-8
- Line 9-12
- Line 13-16
- UC Settings
- XML Application Settings
- ACD Settings
- Call Center Settings
- Line 1-4

Call Center Settings [Line 1 - 4]

Line	Setting	Value
Line 1	Enable Call Center	<input type="radio"/> Yes <input checked="" type="radio"/> No
	Disposition Code	<input type="radio"/> Yes <input checked="" type="radio"/> No
	Customer Originated Trace	<input type="radio"/> Yes <input checked="" type="radio"/> No
	Hoteling Event	<input type="radio"/> Yes <input checked="" type="radio"/> No
	- User ID	<input type="text"/>
	- Password	<input type="password"/>
Line 2	Status Event	<input type="radio"/> Yes <input checked="" type="radio"/> No
	Enable Call Center	<input type="radio"/> Yes <input checked="" type="radio"/> No
	Disposition Code	<input type="radio"/> Yes <input checked="" type="radio"/> No
	Customer Originated Trace	<input type="radio"/> Yes <input checked="" type="radio"/> No
	Hoteling Event	<input type="radio"/> Yes <input checked="" type="radio"/> No
	- User ID	<input type="text"/>
- Password	<input type="password"/>	
Status Event	<input type="radio"/> Yes <input checked="" type="radio"/> No	

Enable Call Center

Description	Selects whether to add menu items for Call Center.
Value Range	<ul style="list-style-type: none"> • Yes • No
Default Value	No
Configuration File Reference	CALL_CENTER_ENABLE_n

Disposition Code

Description	Selects whether to enable the Disposition Code.
Value Range	<ul style="list-style-type: none"> • Yes • No
Default Value	No
Configuration File Reference	CC_DISPOSITION_CODE_ENABLE_n

Customer Originated Trace

Description	Selects whether to enable the Customer Originated Trace.
Value Range	<ul style="list-style-type: none"> • Yes • No
Default Value	No
Configuration File Reference	CC_CUSTOMER_ORG_TRACE_ENABLE_n

Hoteling Event

Description	Selects whether to enable the Hoteling Event.
Value Range	<ul style="list-style-type: none"> • Yes • No
Default Value	No
Configuration File Reference	CC_HOTELING_EVENT_n

- User ID

Description	Specifies the authentication ID required to access the Hoteling service.
Value Range	Max. 32 characters
Default Value	Not stored.
Configuration File Reference	HOTELING_USERID_n

- Password

Description	Specifies the authentication password required to access the Hoteling service.
Value Range	Max. 128 characters
Default Value	Not stored.
Configuration File Reference	HOTELING_PASSWORD_n

Status Event

Description	Selects whether to enable the Status Event.
Value Range	<ul style="list-style-type: none"> • Yes • No
Default Value	No
Configuration File Reference	CC_STATUS_EVENT_ENABLE_n

4.4 System

This section provides detailed descriptions about all the settings classified under the **[System]** tab.

4.4.1 Language Settings

This screen allows you to select the language used for the Web user interface. The language setting is only applicable when you log in to the Web user interface as User.

Note

- If you change the language while logged in to the Web user interface with the User account, the language will be changed after the message "Complete" is displayed. If you are logged in with the Administrator account, the language will be changed when a user logs in to the Web user interface as User.
- The language used for the Web user interface for the Administrator account is always English.
- The language used for the unit remains unchanged even if the language for the Web user interface is changed.

The screenshot shows the 'Language Settings' configuration page. The 'System' tab is active. In the left sidebar, 'Language Settings' is highlighted. The main content area is titled 'Language Settings' and contains two sections: 'Selectable Language' and 'Language Settings'. The 'Selectable Language' section has two rows: 'IP Phone' and 'Web Language', each with a text input field containing 'en,de,es,fr,it,sv,nl,pt,cs' and a label 'RFC3066 code'. The 'Language Settings' section has two rows: 'IP Phone' and 'Web Language', each with a dropdown menu currently set to 'en'. At the bottom of the form are 'Save' and 'Cancel' buttons.

4.4.1.1 Selectable Language

IP Phone

Description	Specifies the selectable language on the unit. Up to 10 languages separated by commas can be registered. (e.g., "en,es,fr,de,it,nl,pt")
--------------------	---

4.4.1 Language Settings

Value Range	<ul style="list-style-type: none">• en: English• es: Spanish• fr: French• de: German• it: Italian• da: Danish• nl: Dutch• sv: Swedish• fi: Finnish• el: Greek• hu: Hungarian• pt: Portuguese• pl: Polish• sk: Slovakian• cs: Czech• sh: Croatian• ru: Russian• uk: Ukrainian• tr: Turkish• no: Norwegian• ro: Romanian• ct: Custom• kk: Kazakh• me: Montenegrin
Default Value	Depends on the country or area.
Configuration File Reference	AVAILABLE_LANGUAGE

Web Language

Description	Specifies the selectable language on the Web. Up to 10 languages separated by commas can be registered. (e.g., "en,es,fr,de,it,nl,pt")
--------------------	---

Value Range	<ul style="list-style-type: none"> • en: English • es: Spanish • fr: French • de: German • it: Italian • nl: Dutch • el: Greek • hu: Hungarian • pt: Portuguese • pl: Polish • sk: Slovakian • cs: Czech • sh: Croatian • ru: Russian • uk: Ukrainian • tr: Turkish • ro: Romanian • ct: Custom • kk: Kazakh • me: Montenegrin
Default Value	Depends on the country or area.
Configuration File Reference	AVAILABLE_LANGUAGE_WEB

4.4.1.2 Language Settings

IP Phone

Description	Selects the default language on the unit. You can select a language from the languages set in IP Phone in 4.4.1.1 Selectable Language .
Value Range	en, es, fr, de, it, da, nl, sv, fi, el, hu, pt, pl, sk, cs, sh, ru, uk, tr, no, ro, ct, kk, me → see IP Phone in 4.4.1.1 Selectable Language
Default Value	en
Configuration File Reference	DEFAULT_LANGUAGE

Web Language

Description	Selects the default language on the web. You can select a language from the languages set in Web Language in 4.4.1.1 Selectable Language .
Value Range	en, es, fr, de, it, nl, el, hu, pt, pl, sk, cs, sh, ru, uk, tr, ro, ct, kk, me → see Web Language in 4.4.1.1 Selectable Language

4.4.2 User Password Settings

Default Value	en
Configuration File Reference	WEB_LANGUAGE

4.4.2 User Password Settings

This screen allows you to change the password used to authenticate the User account when logging in to the Web user interface.

Note

- For security reasons, the characters entered for the password are masked by special characters, which differ depending on the Web browser.
- After you change the user password, the next time you access the Web user interface, the authentication dialog box appears. Three consecutive login failures will result in an error ("401 Unauthorized"). This restriction only applies the first time you attempt to log in after changing the password. In all other circumstances, an error occurs after 3 unsuccessful login attempts.

4.4.2.1 User Password

Current Password

Description	Specifies the current password to use to authenticate the User account when logging in to the Web user interface.
Value Range	6–64 characters (except !, ", #, \$, %, &, ', (,), @, *, +, ,, /, :, ;, <, =, >, ?, [,], ^, \, {, , }, ~, \ and space)
Default Value	Not stored.

New Password

Description	Specifies the new password to use to authenticate the User account when logging in to the Web user interface.
Value Range	6–64 characters (except !, ", #, \$, %, &, ', (,), @, *, +, ,, /, :, ;, <, =, >, ?, [,], ^, \, {, , }, ~, \ and space) Note <ul style="list-style-type: none"> A hyphen (-) cannot be used as the first character.

Default Value	Not stored. Note <ul style="list-style-type: none"> When a user logs in to the Web user interface for the first time, after clicking OK on the authentication dialog box, the [Initial User Password Settings] screen is displayed automatically to make the user set a password.
Configuration File Reference	USER_PASS

Confirm New Password

Description	Specifies the same password that you entered in [New Password] for confirmation.
Value Range	6–64 characters (except !, ", #, \$, %, &, ', (,), @, *, +, ,, /, :, ;, <, =, >, ?, [,], ^, `, {, , }, ~, \ and space)
Default Value	Not stored.

4.4.3 Admin Password Settings

This screen allows you to change the password used to authenticate the Administrator account when logging in to the Web user interface.

Note

- For security reasons, the characters entered for the password are masked by special characters, which differ depending on the Web browser.
- After you change the administrator password, the next time you access the Web user interface, the authentication dialog box appears. Three consecutive login failures will result in an error ("401 Unauthorized"). This restriction only applies the first time you attempt to log in after changing the password. In all other circumstances, an error occurs after 3 unsuccessful login attempts.

The screenshot displays the 'Admin Password Settings' page. At the top, there are tabs for 'Status', 'Network', 'System' (which is selected and highlighted in red), 'VoIP', 'Telephone', and 'Maintenance'. Below the tabs is a 'Web Port Close' button. On the left side, there is a 'System' menu with options: 'Language Settings', 'User Password Settings', 'Admin Password Settings' (highlighted with a red box), 'Time Adjust Settings', 'Advanced Settings', and 'Import Display File'. The main content area is titled 'Admin Password Settings' and contains three input fields: 'Current Password', 'New Password' (with a '6-64 characters' label), and 'Confirm New Password'. At the bottom of the form are 'Save' and 'Cancel' buttons.

4.4.3.1 Admin Password

Current Password

Description	Specifies the current password to use to authenticate the Administrator account when logging in to the Web user interface.
--------------------	--

4.4.4 Time Adjust Settings

Value Range	6–64 characters (except !, ", #, \$, %, &, ', (,), @, *, +, ,, /, :, ;, <, =, >, ?, [,], ^, `, {, , }, ~, \ and space)
Default Value	adminpass

New Password

Description	Specifies the new password to use to authenticate the Administrator account when logging in to the Web user interface.
Value Range	6–64 characters (except !, ", #, \$, %, &, ', (,), @, *, +, ,, /, :, ;, <, =, >, ?, [,], ^, `, {, , }, ~, \ and space) Note <ul style="list-style-type: none"> A hyphen (-) cannot be used as the first character.
Default Value	Not stored.
Configuration File Reference	ADMIN_PASS

Confirm New Password

Description	Specifies the same password that you entered in [New Password] for confirmation.
Value Range	6–64 characters (except !, ", #, \$, %, &, ', (,), @, *, +, ,, /, :, ;, <, =, >, ?, [,], ^, `, {, , }, ~, \ and space)
Default Value	Not stored.

4.4.4 Time Adjust Settings

This screen allows you to enable automatic clock adjustment using an NTP server and configure the settings for DST (Daylight Saving Time), also known as Summer Time.

4.4.4.1 Synchronization (Synchronisation)

Server Address

Description	Specifies the IP address or FQDN of NTP server.
--------------------	---

Value Range	Max. 256 characters
Default Value	Not stored.
Configuration File Reference	NTP_ADDR

Synchronization Interval (Synchronisation Interval)

Description	Specifies the interval, in seconds, between synchronizations with the NTP server.
Value Range	10–86400
Default Value	43200
Configuration File Reference	TIME_QUERY_INTVL

4.4.4.2 Time Zone

Time Zone

Description	Selects your time zone.
Value Range	GMT -12:00–GMT +13:00
Default Value	GMT
Configuration File Reference	TIME_ZONE

4.4.4.3 Daylight Saving Time (Summer Time)

Enable DST (Enable Summer Time)

Description	Selects whether to enable Daylight Saving Time (Summer Time).
Value Range	<ul style="list-style-type: none"> • Yes • No
Default Value	No
Configuration File Reference	DST_ENABLE

DST Offset (Summer Time Offset)

Description	Specifies the amount of time, in minutes, to change the time when "DST_ENABLE" is set to "Y".
Value Range	0–720 (min)
Default Value	60
Configuration File Reference	DST_OFFSET

4.4.4.4 Start Day and Time of DST (Start Day and Time of Summer Time)

Month

Description	Selects the month in which DST (Summer Time) starts.
--------------------	--

4.4.4 Time Adjust Settings

Value Range	<ul style="list-style-type: none">• January• February• March• April• May• June• July• August• September• October• November• December
Default Value	March
Configuration File Reference	DST_START_MONTH

Day of Week

Using the 2 following settings, specify on which day of the selected month DST (Summer Time) starts. For example, to specify the second Sunday, select **[Second]** and **[Sunday]**.

Description	Selects the number of the week on which DST (Summer Time) starts.
Value Range	<ul style="list-style-type: none">• First• Second• Third• Fourth• Last
Default Value	Second
Configuration File Reference	DST_START_ORDINAL_DAY

Description	Selects the day of the week on which DST (Summer Time) starts.
Value Range	<ul style="list-style-type: none">• Sunday• Monday• Tuesday• Wednesday• Thursday• Friday• Saturday
Default Value	Sunday
Configuration File Reference	DST_START_DAY_OF_WEEK

Time

Description	Specifies the start time of DST (Summer Time) in minutes after 12:00 AM.
Value Range	0–1439 (min)
Default Value	120
Configuration File Reference	DST_START_TIME

4.4.4.5 End Day and Time of DST (End Day and Time of Summer Time)

Month

Description	Selects the month in which DST (Summer Time) ends.
Value Range	<ul style="list-style-type: none"> • January • February • March • April • May • June • July • August • September • October • November • December
Default Value	October
Configuration File Reference	DST_STOP_MONTH

Day of Week

Using the 2 following settings, specify on which day of the selected month DST (Summer Time) ends. For example, to specify the second Sunday, select **[Second]** and **[Sunday]**.

Description	Selects the number of the week on which DST (Summer Time) ends.
Value Range	<ul style="list-style-type: none"> • First • Second • Third • Fourth • Last
Default Value	Second
Configuration File Reference	DST_STOP_ORDINAL_DAY

4.4.5 Advanced Settings

Description	Selects the day of the week on which DST (Summer Time) ends.
Value Range	<ul style="list-style-type: none"> • Sunday • Monday • Tuesday • Wednesday • Thursday • Friday • Saturday
Default Value	Sunday
Configuration File Reference	DST_STOP_DAY_OF_WEEK

Time

Description	Specifies the end time of DST (Summer Time) in minutes after 12:00 AM.
Value Range	0–1439 (min)
Default Value	120
Configuration File Reference	DST_STOP_TIME

4.4.5 Advanced Settings

This screen allows you to change the Soft Key function settings.



4.4.5.1 IP Phone

Enable Admin Ability

Description	Selects whether to enable admin rights for the unit.
Value Range	<ul style="list-style-type: none"> • Yes • No
Default Value	Yes

Configuration File Reference	ADMIN_ABILITY_ENABLE
------------------------------	----------------------

Enable IP Phone Lock

Description	Selects whether to enable locking the unit.
Value Range	<ul style="list-style-type: none"> • Yes • No
Default Value	No
Configuration File Reference	SYS_LOCK_ENABLE

Password for Unlocking

Description	Specifies the password for unlocking the unit.
Value Range	Null, 4 digits (0–9)
Default Value	Not stored.
Configuration File Reference	SYS_LOCK_PASSWORD

4.4.6 Import Display File

This screen allows you to specify the file of the screen saver to import.

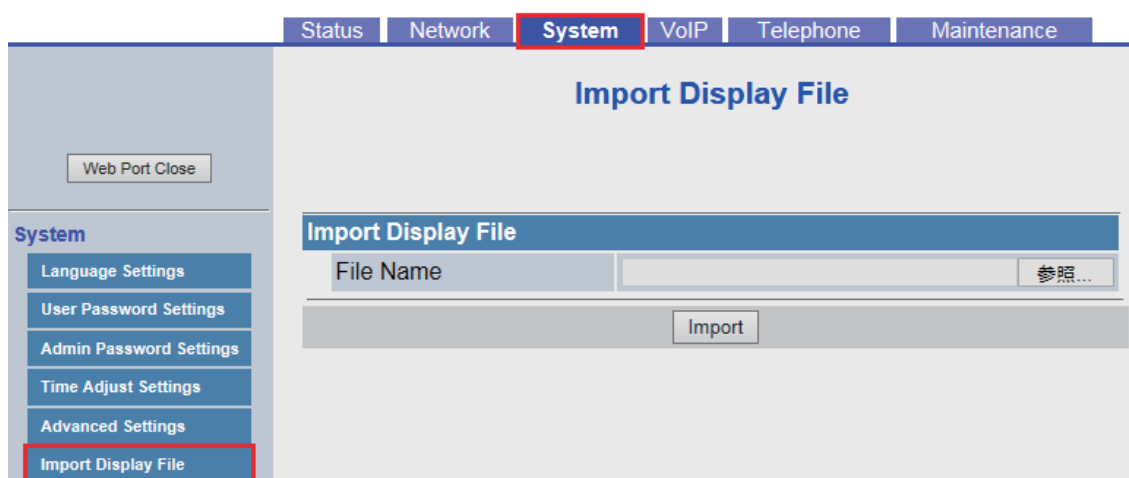

4.4.6.1 Import Display File

File Name

Description	Specifies the file of the screen saver to import.
Value Range	Max. 384 characters
Default Value	Not stored.

4.4.7 Wait Time

This screen allows you to specify the time to wait for the screen saver to display.

4.4.8 Communication Camera

The screenshot shows the 'Wait Time' configuration page. At the top, there are tabs for 'Status', 'Network', 'System' (highlighted), 'VoIP', 'Telephone', and 'Maintenance'. Below the tabs is a 'Web Port Close' button. On the left, a 'System' menu lists various settings, with '- Wait Time' highlighted. The main content area is titled 'Wait Time' and contains a form with a 'Wait Time' label, a dropdown menu set to '0', and the text 'seconds [0: Off]'. Below the form are 'Save' and 'Cancel' buttons.

4.4.7.1 Wait Time

Wait Time

Description	Specifies the time, in seconds, to wait for the screen saver to display.
Value Range	0, 10, 30, 60, 180, 300 (sec) [0:off]
Default Value	0

4.4.8 Communication Camera

This screen allows you to change the Communication Camera settings.

The screenshot shows the 'Communication Camera' configuration page. At the top, there are tabs for 'Status', 'Network', 'System' (highlighted), 'VoIP', 'Telephone', and 'Maintenance'. Below the tabs is a 'Web Port Close' button. On the left, a 'System' menu lists various settings, with 'Communication Camera' highlighted. The main content area is titled 'Communication Camera' and contains a table titled 'Communication Camera Settings'. The table has four columns: 'No.', 'Phone Number', 'Name', and 'Ringtone [1 - 32]'. There are seven rows, each with a number from 1 to 7 in the 'No.' column, empty input fields for 'Phone Number' and 'Name', and a dropdown menu set to '10' in the 'Ringtone' column.

4.4.8.1 Communication Camera Settings [No. 1]–[No. 16]

Phone Number

Description	Specifies the phone number of each Communication Camera.
Value Range	Max. 32 characters (except &, ", ', :, ;, <, >)
Default Value	Not stored.
Configuration File Reference	COMM_CAMERA_NUMBERx

Name

Description	Specifies the name of each Communication Camera.
Value Range	Max. 24 characters
Default Value	Not stored.
Configuration File Reference	COMM_CAMERA_NAMEx

Ringtone [1 - 32]

Description	Specifies the ringtone of each Communication Camera.
Value Range	1–32 (10: doorbell)
Default Value	10
Configuration File Reference	COMM_CAMERA_RINGTONE_SETTINGx

4.5 VoIP

This section provides detailed descriptions about all the settings classified under the **[VoIP]** tab.

4.5.1 SIP Settings

This screen allows you to change the SIP settings that are common to all lines.

The screenshot shows the 'SIP Settings' configuration page. The top navigation bar includes tabs for Status, Network, System, **VoIP**, Telephone, and Maintenance. The 'VoIP' tab is active. On the left, a sidebar lists 'SIP Settings' under the 'VoIP' category, with a list of lines from Line 1 to Line 9. The main content area is titled 'SIP Settings' and contains the following configuration options:

- User Agent:** A text field containing 'Panasonic-{{MODEL}}/{{fwver}} ({{mac}})'. The 'User Agent' label is highlighted in blue.
- NAT Identity:**
 - Enable Rport (RFC 3581):** Radio buttons for 'Yes' and 'No', with 'No' selected.
 - Enable Port Punching for SIP:** A text field with '0' and the label 'seconds [10-300, 0: Disable]'. The label is highlighted in blue.
 - Enable Port Punching for RTP:** A text field with '0' and the label 'seconds [10-300, 0: Disable]'. The label is highlighted in blue.

At the bottom of the configuration area, there are 'Save' and 'Cancel' buttons.

4.5.1.1 User Agent

User Agent

Description	Specifies the text string to send as the user agent in the headers of SIP messages.
Value Range	Max. 64 characters Note <ul style="list-style-type: none"> • If "{mac}" is included in this field, it will be replaced with the unit's MAC address in lower-case. • If "{MAC}" is included in this field, it will be replaced with the unit's MAC address in upper-case. • If "{MODEL}" is included in this field, it will be replaced with the unit's model name. • If "{fwver}" is included in this field, it will be replaced with the firmware version of the unit. • If "{sipver}" is included in this parameter, it will be replaced with the SIP software version of the unit.
Default Value	Panasonic-{MODEL}/{fwver} ({mac})
Configuration File Reference	SIP_USER_AGENT

4.5.1.2 NAT Identity

Enable Rport (RFC 3581)

Description	Selects whether to add the 'rport' parameter to the top Via header field value of requests generated.
Value Range	<ul style="list-style-type: none"> • Yes • No
Default Value	No
Configuration File Reference	SIP_ADD_RPORT

Enable Port Punching for SIP

Description	Specifies the interval, in seconds, between transmissions of the Keep Alive packet in order to maintain the NAT binding information for SIP packet.
Value Range	0, 10–300 0: Disable
Default Value	0
Configuration File Reference	PORT_PUNCH_INTVL

Enable Port Punching for RTP

Description	Specifies the interval, in seconds, between transmissions of the Keep Alive packet in order to maintain the NAT binding information for RTP packet.
Value Range	0, 10–300 0: Disable
Default Value	0
Configuration File Reference	RTP_PORT_PUNCH_INTVL

4.5.2 SIP Settings [Line 1]–[Line 16]

This screen allows you to change the SIP settings that are specific to each line.

4.5.2.1 Basic

Phone Number

Description	Specifies the phone number to use as the user ID required for registration to the SIP registrar server. Note <ul style="list-style-type: none"> When registering using a user ID that is not a phone number, you should use the [SIP URI] setting.
Value Range	Max. 32 characters
Default Value	Not stored.
Configuration File Reference	PHONE_NUMBER_n

Registrar Server Address

Description	Specifies the IP address or FQDN of the SIP registrar server.
--------------------	---

4.5.2 SIP Settings [Line 1]–[Line 16]

Value Range	Max. 256 characters
Default Value	Not stored.
Configuration File Reference	SIP_RGSTR_ADDR_n

Registrar Server Port

Description	Specifies the port number to use for communication with the SIP registrar server.
Value Range	1–65535
Default Value	5060
Configuration File Reference	SIP_RGSTR_PORT_n

Proxy Server Address

Description	Specifies the IP address or FQDN of the SIP proxy server.
Value Range	Max. 256 characters
Default Value	Not stored.
Configuration File Reference	SIP_PRXY_ADDR_n

Proxy Server Port

Description	Specifies the port number to use for communication with the SIP proxy server.
Value Range	1–65535
Default Value	5060
Configuration File Reference	SIP_PRXY_PORT_n

Presence Server Address

Description	Specifies the IP address or FQDN of the SIP presence server.
Value Range	Max. 256 characters
Default Value	Not stored.
Configuration File Reference	SIP_PR SNC_ADDR_n

Presence Server Port

Description	Specifies the port number to use for communication with the SIP presence server.
Value Range	1–65535
Default Value	5060
Configuration File Reference	SIP_PR SNC_PORT_n

Outbound Proxy Server Address

Description	Specifies the IP address or FQDN of the SIP outbound proxy server.
Value Range	Max. 256 characters

Default Value	Not stored.
Configuration File Reference	SIP_OUTPROXY_ADDR_n

Outbound Proxy Server Port

Description	Specifies the port number to use for communication with the SIP outbound proxy server.
Value Range	1–65535
Default Value	5060
Configuration File Reference	SIP_OUTPROXY_PORT_n

Service Domain

Description	Specifies the domain name provided by your phone system dealer/ service provider. The domain name is the part of the SIP URI that comes after the "@" symbol.
Value Range	Max. 256 characters
Default Value	Not stored.
Configuration File Reference	SIP_SVCDOMAIN_n

Authentication ID

Description	Specifies the authentication ID required to access the SIP server.
Value Range	Max. 128 characters
Default Value	Not stored.
Configuration File Reference	SIP_AUTHID_n

Authentication Password

Description	Specifies the authentication password used to access the SIP server.
Value Range	Max. 128 characters
Default Value	Not stored.
Configuration File Reference	SIP_PASS_n

4.5.2.2 Advanced

SIP Packet QoS (DSCP)

Description	Specifies the DSCP (Differentiated Services Code Point) level of DiffServ applied to SIP packets.
Value Range	0–63
Default Value	0
Configuration File Reference	DSCP_SIP_n

Enable DNS SRV lookup

Description	Selects whether to request the DNS server to translate domain names into IP addresses using the SRV record.
Value Range	<ul style="list-style-type: none"> • Yes • No <p>Note</p> <ul style="list-style-type: none"> • If you select [Yes], the unit will perform a DNS SRV lookup for a SIP registrar server, SIP proxy server, SIP outbound proxy server, or SIP presence server. If you select [No], the unit will not perform a DNS SRV lookup for a SIP registrar server, SIP proxy server, SIP outbound proxy server, or SIP presence server.
Default Value	Yes
Configuration File Reference	SIP_DNSSRV_ENA_n

SRV lookup Prefix for UDP

Description	Specifies a prefix to add to the domain name when performing a DNS SRV lookup using UDP.
	<p>Note</p> <ul style="list-style-type: none"> • This setting is available only when [Enable DNS SRV lookup] is set to [Yes].
Value Range	Max. 32 characters
Default Value	_sip._udp.
Configuration File Reference	SIP_UDP_SRV_PREFIX_n

SRV lookup Prefix for TCP

Description	Specifies a prefix to add to the domain name when performing a DNS SRV lookup using TCP.
	<p>Note</p> <ul style="list-style-type: none"> • This setting is available only when [Enable DNS SRV lookup] is set to [Yes].
Value Range	Max. 32 characters
Default Value	_sip._tcp.
Configuration File Reference	SIP_TCP_SRV_PREFIX_n

SRV lookup Prefix for TLS

Description	Specifies a prefix to add to the domain name when performing a DNS SRV lookup using TLS.
	<p>Note</p> <ul style="list-style-type: none"> • This setting is available only when [Enable DNS SRV lookup] is set to [Yes].

Value Range	Max. 32 characters
Default Value	_sips._tls.
Configuration File Reference	SIP_TLS_SRV_PREFIX_n

Local SIP Port

Description	Specifies the source port number used by the unit for SIP communication.
Value Range	1024–49151
Default Value	5060 (for Line 1) 5070 (for Line 2) 5080 (for Line 3) 5090 (for Line 4) 5100 (for Line 5) 5110 (for Line 6) 5120 (for Line 7) 5130 (for Line 8) 5140 (for Line 9) 5150 (for Line 10) 5160 (for Line 11) 5170 (for Line 12) 5180 (for Line 13) 5190 (for Line 14) 5200 (for Line 15) 5210 (for Line 16)
Configuration File Reference	SIP_SRC_PORT_n

SIP URI

Description	Specifies the unique ID used by the SIP registrar server, which consists of "sip:", a user part, the "@" symbol, and a host part, for example, "sip:user@example.com", "2405551111_1". Note <ul style="list-style-type: none"> When registering using a user ID that is not a phone number, you should use this setting. In a SIP URI, the user part ("user" in the example above) can contain up to 63 characters, and the host part ("example.com" in the example above) can contain up to 316 characters.
Value Range	Max. 384 characters
Default Value	Not stored.
Configuration File Reference	SIP_URI_n

T1 Timer

Description	Specifies the default interval, in milliseconds, between transmissions of SIP messages.
--------------------	---

4.5.2 SIP Settings [Line 1]–[Line 16]

Value Range	<ul style="list-style-type: none">• 250• 500• 1000• 2000• 4000
Default Value	500
Configuration File Reference	SIP_TIMER_T1_n

T2 Timer

Description	Specifies the maximum interval, in seconds, between transmissions of SIP messages.
Value Range	<ul style="list-style-type: none">• 2• 4• 8• 16• 32
Default Value	4
Configuration File Reference	SIP_TIMER_T2_n

REGISTER Expires Timer

Description	Specifies the length of time, in seconds, that the registration remains valid. This value is set in the "Expires" header of the REGISTER request.
Value Range	1–4294967295
Default Value	3600
Configuration File Reference	REG_EXPIRE_TIME_n

Enable Session Timer (RFC 4028)

Description	Specifies the length of time, in seconds, that the unit waits before terminating SIP sessions when no reply to repeated requests is received.
Value Range	0, 60–65535
Default Value	0
Configuration File Reference	SIP_SESSION_TIME_n

Session Timer Method

Description	Selects the refreshing method of SIP sessions.
Value Range	<ul style="list-style-type: none">• INVITE• UPDATE• INVITE/UPDATE

Default Value	INVITE
Configuration File Reference	SIP_SESSION_METHOD_n

Enable 100rel (RFC 3262)

Description	Specifies whether to add the option tag 100rel to the "Supported" header of the INVITE message.
Value Range	<ul style="list-style-type: none"> • Yes • No <p>Note</p> <ul style="list-style-type: none"> • If you select [Yes], the Reliability of Provisional Responses function will be enabled. The option tag 100rel will be added to the "Supported" header of the INVITE message and to the "Require" header of the "1xx" provisional message. If you select [No], the option tag 100rel will not be used.
Default Value	Yes
Configuration File Reference	SIP_100REL_ENABLE_n

Enable SSAF (SIP Source Address Filter)

Description	Selects whether to enable SSAF for the SIP servers (registrar server, proxy server, and presence server).
Value Range	<ul style="list-style-type: none"> • Yes • No
Default Value	No
Configuration File Reference	SIP_DETECT_SSAF_n

Enable c=0.0.0.0 Hold (RFC 2543)

Description	Selects whether to enable the RFC 2543 Call Hold feature on this line.
Value Range	<ul style="list-style-type: none"> • Yes • No <p>Note</p> <ul style="list-style-type: none"> • If you select [Yes], the "c=0.0.0.0" syntax will be set in SDP when sending a re-INVITE message to hold the call. If you select [No], the "c=x.x.x.x" syntax will be set in SDP.
Default Value	Yes
Configuration File Reference	RFC2543_HOLD_ENABLE_n

Transport Protocol

Description	Selects which transport layer protocol to use for sending SIP packets.
--------------------	--

4.5.3 VoIP Settings

Value Range	<ul style="list-style-type: none"> • UDP • TCP • TLS
Default Value	UDP
Configuration File Reference	SIP_TRANSPORT_n

TLS Mode

Description	Select the secure SIP protocol.
Value Range	<ul style="list-style-type: none"> • SIPS • SIP-TLS
Default Value	SIPS
Configuration File Reference	SIP_TLS_MODE_n

4.5.3 VoIP Settings

This screen allows you to change the VoIP settings that are common to all lines.

The screenshot shows the VoIP Settings configuration page. The navigation bar includes tabs for Status, Network, System, VoIP, Telephone, and Maintenance. The VoIP tab is active. The sidebar on the left shows a list of lines (Line 1 to Line 16) and a 'VoIP Settings' option, which is highlighted. The main content area is titled 'VoIP Settings' and contains the following configuration options:

RTP

- RTP Packet Time: 20 milliseconds
- Minimum RTP Port Number: 16000 [1024-59598: Even Number Only]
- Maximum RTP Port Number: 20000 [1424-59998: Even Number Only]
- Telephone-event Payload Type: 101 [96-127]

Voice Quality Report

- Server Address: [Empty field]
- Port: 5060 [1-65535]
- Enable PUBLISH: Disable
- Alert Report Trigger: Warning Critical
- Threshold MOS-LQ (Critical): 0 [0-40]
- Threshold MOS-LQ (Warning): 0 [0-40]
- Threshold Delay (Critical): 0 milliseconds [0-2000]
- Threshold Delay (Warning): 0 milliseconds [0-2000]

At the bottom of the form, there are 'Save' and 'Cancel' buttons.

4.5.3.1 RTP

RTP Packet Time

Description	Selects the interval, in milliseconds, between transmissions of RTP packets.
Value Range	<ul style="list-style-type: none"> • 20 • 30 • 40 • 60
Default Value	20
Configuration File Reference	RTP_PTIME

Minimum RTP Port Number

Description	Specifies the lowest port number that the unit will use for RTP packets.
Value Range	1024–59598 (even number only)
Default Value	16000
Configuration File Reference	RTP_PORT_MIN

Maximum RTP Port Number

Description	Specifies the highest port number that the unit will use for RTP packets.
Value Range	1424–59998 (even number only)
Default Value	20000
Configuration File Reference	RTP_PORT_MAX

Telephone-event Payload Type

Description	<p>Specifies the RFC 2833 payload type for DTMF tones.</p> <p>Note</p> <ul style="list-style-type: none"> • This setting is available only when [DTMF Type] is set to [RFC2833].
Value Range	96–127
Default Value	101
Configuration File Reference	TELEVENT_PAYLOAD

4.5.3.2 Voice Quality Report

Server Address

Description	Specifies the IP address or FQDN of the collector server.
Value Range	Max. 256 characters

4.5.3 VoIP Settings

Default Value	Not stored.
Configuration File Reference	VQREPORT_COLLECTOR_ADDRESS

Port

Description	Specifies the port of the collector server.
Value Range	1–65535
Default Value	5060
Configuration File Reference	VQREPORT_COLLECTOR_PORT

Enable PUBLISH

Description	Selects the sending type of the VQ report using PUBLISH.
Value Range	<ul style="list-style-type: none">• Disable• End of Session Report Using PUBLISH• Interval report Using PUBLISH• Alert Report Using PUBLISH
Default Value	Disable
Configuration File Reference	VQREPORT_SEND

Alert Report Trigger

Description	Selects the trigger to notify the VQ report.
Value Range	<ul style="list-style-type: none">• Warning• Critical
Default Value	Warning
Configuration File Reference	ALERT_REPORT_TRIGGER

Threshold MOS-LQ (Critical)

Description	Specifies the criteria (critical) to send the VQ report when the MOSQ occurs.
Value Range	0–40
Default Value	0
Configuration File Reference	ALERT_REPORT_MOSQ_CRITICAL

Threshold MOS-LQ (Warning)

Description	Specifies the criteria (warning) to send the VQ report when the MOSQ occurs.
Value Range	0–40
Default Value	0
Configuration File Reference	ALERT_REPORT_MOSQ_WARNING

Threshold Delay (Critical)

Description	Specifies the criteria (critical) to send the VQ report when a delay occurs.
Value Range	0–2000
Default Value	0
Configuration File Reference	ALERT_REPORT_DELAY_CRITICAL

Threshold Delay (Warning)

Description	Specifies the criteria (warning) to send the VQ report when a delay occurs.
Value Range	0–2000
Default Value	0
Configuration File Reference	ALERT_REPORT_DELAY_WARNING

4.5.4 VoIP Settings [Line 1]–[Line 16]

This screen allows you to change the VoIP settings that are specific to each line.

4.5.4 VoIP Settings [Line 1]–[Line 16]

4.5.4.1 Basic

G.722 Enable

Description	Selects whether to enable the G.722 codec for voice data transmission.
Value Range	<ul style="list-style-type: none"> • Yes • No
Default Value	Yes
Configuration File Reference	CODEC_ENABLEx_n

G.722 Priority

Description	Specifies the numerical order usage priority for the G.722 codec.
Value Range	1–255
Default Value	1
Configuration File Reference	CODEC_PRIORITYx_n

PCMA Enable

Description	Selects whether to enable the PCMA codec for voice data transmission.
Value Range	<ul style="list-style-type: none"> • Yes • No
Default Value	Yes
Configuration File Reference	CODEC_ENABLEx_n

PCMA Priority

Description	Specifies the numerical order usage priority for the PCMA codec.
Value Range	1–255
Default Value	1
Configuration File Reference	CODEC_PRIORITYx_n

G.729A Enable

Description	Selects whether to enable the G.729A codec for voice data transmission.
Value Range	<ul style="list-style-type: none"> • Yes • No
Default Value	Yes
Configuration File Reference	CODEC_ENABLEx_n

G.729A Priority

Description	Specifies the numerical order usage priority for the G.729A codec.
Value Range	1–255
Default Value	1
Configuration File Reference	CODEC_PRIORITYx_n

PCMU Enable

Description	Selects whether to enable the PCMU codec for voice data transmission.
Value Range	<ul style="list-style-type: none"> • Yes • No
Default Value	Yes
Configuration File Reference	CODEC_ENABLEx_n

PCMU Priority

Description	Specifies the numerical order usage priority for the PCMU codec.
Value Range	1–255

4.5.4 VoIP Settings [Line 1]–[Line 16]

Default Value	1
Configuration File Reference	CODEC_PRIORITYx_n

DTMF Type

Description	Selects the method for transmitting DTMF (Dual Tone Multi-Frequency) tones.
Value Range	<ul style="list-style-type: none">• RFC2833• Inband• SIP INFO <p>Note</p> <ul style="list-style-type: none">• RFC2833 refers to Outband DTMF.• Inband referes to Inband DTMF.
Default Value	RFC2833
Configuration File Reference	DTMF_METHOD_n

4.5.4.2 Advanced

RTP Packet QoS (DSCP)

Description	Specifies the DSCP level of DiffServ applied to RTP packets.
Value Range	0–63
Default Value	0
Configuration File Reference	DSCP_RTP_n

RTCP Packet QoS (DSCP)

Description	Specifies the DSCP level of DiffServ applied to RTCP/RTCP-XR packets.
Value Range	0–63
Default Value	0
Configuration File Reference	DSCP_RTCP_n

Enable RTCP

Description	Selects whether to enable or disable RTCP.
Value Range	<ul style="list-style-type: none">• Yes• No
Default Value	No
Configuration File Reference	RTCP_ENABLE_n

Enable RTCP-XR

Description	Selects whether to enable or disable RTCP-XR.
-------------	---

Value Range	<ul style="list-style-type: none"> • Yes • No
Default Value	No
Configuration File Reference	RTCPXR_ENABLE_n

RTCP&RTCP-XR Interval

Description	Specifies the interval, in seconds, between RTCP/RTCP-XR packets.
Value Range	5–65535
Default Value	5
Configuration File Reference	RTCP_INTVL_n

SRTP Mode

Description	Selects the mode of SRTP feature.
Value Range	<ul style="list-style-type: none"> • SRTP • RTP/SRTP <p>Note</p> <ul style="list-style-type: none"> • SRTP: Use only SRTP for outgoing and incoming calls. • RTP/SRTP: Use only RTP for outgoing calls, and RTP or SRTP for incoming calls.
Default Value	RTP/SRTP
Configuration File Reference	SRTP_CONNECT_MODE_n

Enable Mixed SRTP & RTP by Conference

Description	Selects whether to allow conferences where each participant can use either SRTP or RTP.
Value Range	<ul style="list-style-type: none"> • Yes • No
Default Value	No
Configuration File Reference	SRTP_MIX_CONFERENCE_ENABLE_n

Enable Mixed SRTP & RTP by Transfer

Description	Selects whether to allow call transfers between a user who is using SRTP and a user who is using RTP.
Value Range	<ul style="list-style-type: none"> • Yes • No
Default Value	No
Configuration File Reference	SRTP_MIX_TRANSFER_ENABLE_n

4.6 Telephone

This section provides detailed descriptions about all the settings classified under the **[Telephone]** tab.

4.6.1 Call Control

This screen allows you to configure various call features that are common to all lines.

Call Control	
Send SUBSCRIBE to Voice Mail Server	<input type="radio"/> Yes <input checked="" type="radio"/> No
Conference Server URI	<input type="text"/>
First-digit Timeout	<input type="text" value="30"/> seconds [1-600]
Inter-digit Timeout	<input type="text" value="5"/> seconds [1-15]
Timer for Dial Plan	<input type="text" value="5"/> seconds [1-15]
Enable # Key as delimiter	<input checked="" type="radio"/> Yes <input type="radio"/> No
International Call Prefix	<input type="text"/>

4.6.1.1 Call Control

Send SUBSCRIBE to Voice Mail Server

Description	Selects whether to send the SUBSCRIBE request to a voice mail server. Note <ul style="list-style-type: none"> Your phone system must support voice mail.
Value Range	<ul style="list-style-type: none"> Yes No
Default Value	No
Configuration File Reference	VM_SUBSCRIBE_ENABLE

Conference Server URI

Description	Specifies the URI for a conference server, which consists of "sip:", a user part, the "@" symbol, and a host part, for example, "sip:conference@example.com". Note <ul style="list-style-type: none"> Availability depends on your phone system.
Value Range	Max. 256 characters

Default Value	Not stored.
Configuration File Reference	CONFERENCE_SERVER_URI

First-digit Timeout

Description	Specifies the length of time, in seconds, within which the first digits of a dial number must be dialed.
Value Range	1–600 (s)
Default Value	30
Configuration File Reference	FIRSTDIGIT_TIM

Inter-digit Timeout

Description	Specifies the length of time, in seconds, within which subsequent digits of a dial number must be dialed.
Value Range	1–15 (s)
Default Value	5
Configuration File Reference	INTDIGIT_TIM

Timer for Dial Plan

Description	Specifies the length of time, in seconds, that the unit waits when a "T" or "t" has been entered in the dial plan.
Value Range	1–15 (s)
Default Value	5
Configuration File Reference	MACRODIGIT_TIM

Enable # Key as delimiter

Description	Selects whether the # key is treated as a regular dialed digit or a delimiter, when dialed as or after the second digit.
Value Range	<ul style="list-style-type: none"> • Yes: # is treated as the end of dialing delimiter. • No: # is treated as a regular dialed digit.
Default Value	Yes
Configuration File Reference	POUND_KEY_DELIMITER_ENABLE

International Call Prefix

Description	Specifies the number to be shown in the place of the first "+" symbol when the phone number for incoming international calls contains "+".
Value Range	Max. 8 characters (consisting of 0–9, *, and #)
Default Value	Not stored.
Configuration File Reference	INTERNATIONAL_ACCESS_CODE

Country Calling Code

Description	Specifies the country/area calling code to be used for comparative purposes when dialing a number from the incoming call log that contains a "+" symbol.
Value Range	Max. 8 characters (consisting of 0–9, *, and #)
Default Value	Not stored.
Configuration File Reference	COUNTRY_CALLING_CODE

National Access Code

Description	When dialing a number from the incoming call log that contains a "+" symbol and the country calling code matches, the country calling code is removed and the national access code is added.
Value Range	Max. 8 characters (consisting of 0–9, *, and #)
Default Value	Not stored.
Configuration File Reference	NATIONAL_ACCESS_CODE

Default Line for Outgoing

Description	Selects the line used to make an outgoing call when no line is specified in the dialing operation.
Value Range	<ul style="list-style-type: none"> • Line 1 • Line 2 • Line 3 • Line 4 • Line 5 • Line 6 • Line 7 • Line 8 • Line 9 • Line 10 • Line 11 • Line 12 • Line 13 • Line 14 • Line 15 • Line 16
Default Value	Line 1
Configuration File Reference	DEFAULT_LINE_SELECT

Call Park Number

Description	Specifies the call parking number.
--------------------	------------------------------------

Value Range	0–4 digits (0–9, *, #)
Default Value	Not stored.
Configuration File Reference	NUM_PLAN_PARKING

Enable Call Park Key

Description	Selects whether to display "Call Park" in the Call Parking Func menu.
Value Range	<ul style="list-style-type: none"> • Yes • No
Default Value	No
Configuration File Reference	CALLPARK_KEY_ENABLE

Park Retrieve Number

Description	Specifies the call park retrieve number.
Value Range	0–4 digits (0–9, *, #)
Default Value	Not stored.
Configuration File Reference	NUM_PLAN_PARK_RETRIEVING

Directed Call Pickup

Description	Specifies the feature number assigned to a BLF for performing call pickup.
Value Range	0–4 digits (0–9, *, #)
Default Value	Not stored.
Configuration File Reference	NUM_PLAN_PICKUP_DIRECT

4.6.1.2 Emergency Call Phone Numbers

1–5

Description	Specifies the phone numbers used for making emergency calls. A user can dial any of the specified phone numbers at any time regardless of any restrictions imposed on the unit. A maximum of 5 phone numbers can be specified.
Value Range	Max. 32 characters (except &, ", ', : ; , <, >)
Default Value	Not stored.
Configuration File Reference	EMERGENCY_CALLx

4.6.1.3 Call Rejection Phone Numbers

1–30

Description	Specifies the phone numbers to reject incoming calls from. A maximum of 30 phone numbers can be specified.
Value Range	Max. 32 characters (except &, ", ', : ; , <, >)

4.6.2 Call Control [Line 1]–[Line 16]

Default Value	Not stored.
Configuration File Reference	CALL_REJECTIONx

4.6.2 Call Control [Line 1]–[Line 16]

This screen allows you to configure various call features that are specific to each line.

Call Features	
Display Name	<input type="text"/>
Voice Mail Access Number	<input type="text"/>
Enable Anonymous Call	<input type="radio"/> Yes <input checked="" type="radio"/> No
Enable Block Anonymous Call	<input type="radio"/> Yes <input checked="" type="radio"/> No
Enable Do Not Disturb	<input type="radio"/> Yes <input checked="" type="radio"/> No
Enable Call Waiting	<input checked="" type="radio"/> Yes <input type="radio"/> No
Enable Call Forwarding Always	<input type="radio"/> Yes <input checked="" type="radio"/> No
Forwarding Number (Always)	<input type="text"/>

4.6.2.1 Call Features

Display Name

Description	Specifies the name to display as the caller on the other party's phone when you make a call.
Value Range	Max. 24 characters Note <ul style="list-style-type: none"> You can use Unicode characters for this setting.
Default Value	Not stored.
Configuration File Reference	DISPLAY_NAME_n

Voice Mail Access Number

Description	Specifies the phone number used to access the voice mail server. Note <ul style="list-style-type: none"> Your phone system must support voice mail.
Value Range	Max. 32 characters
Default Value	Not stored.
Configuration File Reference	VM_NUMBER_n

Enable Anonymous Call

Description	Selects whether to make calls without transmitting the phone number to the called party.
Value Range	<ul style="list-style-type: none"> • Yes • No
Default Value	No
Configuration File Reference	ANONYMOUS_CALL_ENABLE_n

Enable Block Anonymous Call

Description	Selects whether to accept or reject the incoming call without the called party's phone number.
Value Range	<ul style="list-style-type: none"> • Yes • No
Default Value	No
Configuration File Reference	BLOCK_ANONYMOUS_CALL_ENABLE_n

Enable Do Not Disturb

Description	Selects whether to reject the all incoming calls.
Value Range	<ul style="list-style-type: none"> • Yes • No
Default Value	No

Enable Call Waiting

Description	Selects whether to enable Call Waiting.
Value Range	<ul style="list-style-type: none"> • Yes • No
Default Value	Yes
Configuration File Reference	CW_ENABLE_n

Enable Call Forwarding Always

Description	Selects whether to forward all incoming calls to a specified destination.
Value Range	<ul style="list-style-type: none"> • Yes • No
Default Value	No

Forwarding Number (Always)

Description	Specifies the phone number of the destination to forward all incoming calls to.
Value Range	Max. 32 characters

Default Value	Not stored.
---------------	-------------

Enable Call Forwarding Busy

Description	Selects whether to forward incoming calls to a specified destination when the line is in use.
Value Range	<ul style="list-style-type: none"> • Yes • No
Default Value	No

Forwarding Number (Busy)

Description	Specifies the phone number of the destination to forward calls to when the line is in use.
Value Range	Max. 32 characters
Default Value	Not stored.

Enable Call Forwarding No Answer

Description	Selects whether to forward incoming calls to a specified destination when a call is not answered after it has rung a specified number of times.
Value Range	<ul style="list-style-type: none"> • Yes • No
Default Value	No

Forwarding Number (No Answer)

Description	Specifies the phone number of the destination to forward calls to when a call is not answered after it has rung a specified number of times.
Value Range	Max. 32 characters
Default Value	Not stored.

Ring Counts (No Answer)

Description	Specifies the number of times that an incoming call rings until the call is forwarded.
Value Range	0, 2–20
Default Value	3

Enable Shared Call

Description	<p>Selects whether to enable the Shared Call feature of the SIP server, which is used to share one line among the units.</p> <p>Note</p> <ul style="list-style-type: none"> • Availability depends on your phone system.
-------------	--

Value Range	<ul style="list-style-type: none"> • Yes • No <p>Note</p> <ul style="list-style-type: none"> • If you select [Yes], the SIP server will control the line by using a shared-call signaling method. If you select [No], the SIP server will control the line by using a standard signaling method.
Default Value	No
Configuration File Reference	SHARED_CALL_ENABLE_n

Enable Key Synchronization (Enable Key Synchronisation)

Description	Selects whether to synchronize the Do Not Disturb and Call Forward settings.
	<p>Note</p> <ul style="list-style-type: none"> • Even if you select [Yes], this feature may not function properly if your phone system does not support it. Before you configure this setting, consult your phone system dealer/service provider.
Value Range	<ul style="list-style-type: none"> • Yes • No
Default Value	No
Configuration File Reference	FWD_DND_SYNCHRO_ENABLE_n

Enable Call Park Notification

Description	Selects whether to respond to call park notifications from the server.
Value Range	<ul style="list-style-type: none"> • Yes • No
Default Value	No
Configuration File Reference	CALLPARK_NOTIFICATION_ENABLE_n

Enable Click to Call

Description	Selects whether to enable Click to Dial/Answer/Hold functions.
Value Range	<ul style="list-style-type: none"> • Yes • No
Default Value	No
Configuration File Reference	CLICKTO_ENABLE_n

Enable Executive Setting

Description	Selects whether to enable or disable the Executive Call Filtering feature of the selected line.
--------------------	---

4.6.2 Call Control [Line 1]–[Line 16]

Value Range	<ul style="list-style-type: none">• Yes• No
Default Value	No
Configuration File Reference	BS_EXECUTIVE_SETTING_ENABLE_n

Enable Assistant Setting

Description	Selects whether to enable the Executive-Assistant Call Filtering feature and the Executive-Assistant Divert feature of the selected line.
Value Range	<ul style="list-style-type: none">• Yes• No
Default Value	No
Configuration File Reference	BS_ASSISTANT_SETTING_ENABLE_n

MoH Server URI

Description	Specifies MoH server URI for each line.
Value Range	Max. 384 characters
Default Value	Not stored.
Configuration File Reference	MOH_SERVER_URI_n

Resource List URI

Description	Specifies the URI for the resource list, which consists of "sip:", a user part, the "@" symbol, and a host part.
Value Range	Max. 256 characters
Default Value	Not stored.
Configuration File Reference	RESOURCELIST_URI_n

4.6.2.2 Dial Plan

Dial Plan (max 1000 columns)

Description	Specifies a dial format, such as specific phone numbers, that control which numbers can be dialed or how to handle the call when making a call. For details, see 6.2 Dial Plan .
Value Range	Max. 1000 characters
Default Value	Not stored.
Configuration File Reference	DIAL_PLAN_n

Call Even If Dial Plan Does Not Match

Description	Selects whether to make a call even if the dialed number does not match any of the dial formats specified in [Dial Plan] .
--------------------	---

Value Range	<ul style="list-style-type: none"> • Yes • No <p>Note</p> <ul style="list-style-type: none"> • If you select [Yes], calls will be made even if the dialed number does not match the dial formats specified in [Dial Plan] (i.e., dial plan filtering is disabled). If you select [No], calls will not be made if the dialed number does not match one of the dial formats specified in [Dial Plan] (i.e., dial plan filtering is enabled).
Default Value	Yes
Configuration File Reference	DIAL_PLAN_NOT_MATCH_ENABLE_n

4.6.3 Hotline Settings

The screenshot shows a web interface with a top navigation bar containing tabs: Status, Network, System, VoIP, Telephone (highlighted), and Maintenance. Below the navigation bar is a sidebar with a 'Web Port Close' button and a 'Telephone' section containing a list of lines from Line 1 to Line 16, with 'Hotline Settings' highlighted at the bottom. The main content area is titled 'Hotline Settings' and contains a 'Hotline' configuration box. This box has three rows: 'Enable' with radio buttons for 'Yes' and 'No'; 'Hotline Number' with a text input field; and 'Hotline Delay' with a text input field containing '2' and the label 'seconds [0-10]'. At the bottom of the configuration box are 'Save' and 'Cancel' buttons.

4.6.3.1 Hotline

Enable

Description	Selects whether to enable or disable the Hot line feature.
--------------------	--

4.6.4 Flexible Key Settings (No. 1–24)

Value Range	<ul style="list-style-type: none">• Yes• No
Default Value	No
Configuration File Reference	HOTLINE_ENABLE

Hotline Number

Description	Specifies the Hot line number.
Value Range	Max. 32 characters
Default Value	Not stored.
Configuration File Reference	HOTLINE_NUMBER

Hotline Delay

Description	Specifies a time after off hook for Hot line.
Value Range	0–10 (s)
Default Value	2
Configuration File Reference	HOTLINE_TIM

4.6.4 Flexible Key Settings (No. 1–24)

This screen allows you to configure various features for each flexible key.

Status Network System VoIP **Telephone** Maintenance

Web Port Close

Telephone

Call Control

- Line 1
- Line 2
- Line 3
- Line 4
- Line 5
- Line 6
- Line 7
- Line 8
- Line 9
- Line 10
- Line 11
- Line 12
- Line 13
- Line 14
- Line 15
- Line 16

Hotline Settings

Flexible Key Settings

Flexible Key Settings			
No.	Type	Parameter	Label Name
1	<input type="text"/>	<input type="text"/>	<input type="text"/>
2	<input type="text"/>	<input type="text"/>	<input type="text"/>
3	<input type="text"/>	<input type="text"/>	<input type="text"/>
4	<input type="text"/>	<input type="text"/>	<input type="text"/>
5	<input type="text"/>	<input type="text"/>	<input type="text"/>
6	<input type="text"/>	<input type="text"/>	<input type="text"/>
7	<input type="text"/>	<input type="text"/>	<input type="text"/>
8	<input type="text"/>	<input type="text"/>	<input type="text"/>
9	<input type="text"/>	<input type="text"/>	<input type="text"/>
10	<input type="text"/>	<input type="text"/>	<input type="text"/>
11	<input type="text"/>	<input type="text"/>	<input type="text"/>
12	<input type="text"/>	<input type="text"/>	<input type="text"/>
13	<input type="text"/>	<input type="text"/>	<input type="text"/>
14	<input type="text"/>	<input type="text"/>	<input type="text"/>
15	<input type="text"/>	<input type="text"/>	<input type="text"/>
16	<input type="text"/>	<input type="text"/>	<input type="text"/>
17	<input type="text"/>	<input type="text"/>	<input type="text"/>

4.6.4.1 Flexible Key Settings

Type

Description	Selects the feature to be assigned to each flexible key.
--------------------	--

4.6.5 Tone Settings

Value Range	<ul style="list-style-type: none">• One Touch Dial• BLF• Line• ACD• Wrap Up• Line Status• Call Forward• Phonebook• Call History• Simultaneous Ring• Hoteling (Hospitality)• Transfer• Blind Transfer• Conference• Directed Call Pickup• Call Park• Call Park Retrieve• Network Camera
Default Value	Not stored.
Configuration File Reference	FLEX_BUTTON_FACILITY_ACTx

Parameter

Description	Specifies the necessary values for the features assigned to flexible keys.
Value Range	Max. 35 characters
Default Value	Not stored.
Configuration File Reference	FLEX_BUTTON_FACILITY_ARGx

Label Name

Description	Specifies the message to be displayed on the screen when the flexible key is pressed.
Value Range	Max. 20 characters
Default Value	Not stored.
Configuration File Reference	FLEX_BUTTON_LABELx

4.6.5 Tone Settings

This screen allows you to configure the dual-tone frequencies and ringtone patterns of each tone.

The screenshot shows the 'Tone Settings' configuration page. The navigation tabs are Status, Network, System, VoIP, Telephone (selected), and Maintenance. The left sidebar includes 'Web Port Close', 'Telephone', 'Call Control', and a list of lines from 1 to 16. The 'Tone Settings' option is highlighted in the sidebar. The main content area contains the following settings:

Section	Tone Frequencies	Tone Timings
Dial Tone	350,440	60,0
Busy Tone	480,620	60,500,440
Ringing Tone	440,480	60,2000,3940
Stutter Tone	350,440	560,100,100,100,100,100,100,100,100,100,100
Reorder Tone	480,620	60,250,190

At the bottom of the main area are 'Save' and 'Cancel' buttons.

4.6.5.1 Dial Tone

Tone Frequencies

Description	Specifies the dual-tone frequencies, in hertz, of dial tones using 2 whole numbers separated by a comma.
Value Range	0, 200–2000 (0: No tone) Note <ul style="list-style-type: none"> If the value for this setting is "350,440", the unit will use a mixed signal of a 350 Hz tone and a 440 Hz tone.
Default Value	350,440
Configuration File Reference	DIAL_TONE1_FRQ

Tone Timings

Description	Specifies the pattern, in milliseconds, of dial tones using up to 10 whole numbers (off 1, on 1, off 2, on 2...) separated by commas. Note <ul style="list-style-type: none"> The unit will not play the tone for the duration of the first value, play it for the duration of the second value, stop it for the duration of the third value, play it again for the duration of the fourth value, and so on. The whole sequence will then repeat. For example, if the value for this setting is "100,100,100,0", the unit will not play the tone for 100 ms, play it for 100 ms, stop it for 100 ms, and then play it continuously. It is recommended that you set a value of 60 milliseconds or more for the first value (off 1).
Value Range	0–16000 (0: Infinite time) Note <ul style="list-style-type: none"> Avoid setting 1–50 for any of the values.
Default Value	60,0
Configuration File Reference	DIAL_TONE1_TIMING

4.6.5.2 Busy Tone

Tone Frequencies

Description	Specifies the dual-tone frequencies, in hertz, of busy tones using 2 whole numbers separated by a comma.
Value Range	0, 200–2000 (0: No tone) Note <ul style="list-style-type: none"> If the value for this setting is "480,620", the unit will use a mixed signal of a 480 Hz tone and a 620 Hz tone.
Default Value	480,620
Configuration File Reference	BUSY_TONE_FRQ

Tone Timings

Description	Specifies the pattern, in milliseconds, of busy tones using up to 10 whole numbers (off 1, on 1, off 2, on 2...) separated by commas.
Value Range	0–16000 (0: Infinite time) Note <ul style="list-style-type: none"> Avoid setting 1–50 for any of the values.
Default Value	60,500,440
Configuration File Reference	BUSY_TONE_TIMING

4.6.5.3 Ringing Tone

Tone Frequencies

Description	Specifies the dual-tone frequencies, in hertz, of ringback tones using 2 whole numbers separated by a comma.
Value Range	0, 200–2000 (0: No tone) Note <ul style="list-style-type: none"> If the value for this setting is "440,480", the unit will use a mixed signal of a 440 Hz tone and a 480 Hz tone.
Default Value	440,480
Configuration File Reference	RINGBACK_TONE_FRQ

Tone Timings

Description	Specifies the pattern, in milliseconds, of ringback tones using up to 10 whole numbers (off 1, on 1, off 2, on 2...) separated by commas. Note <ul style="list-style-type: none"> It is recommended that you set a value of 60 milliseconds or more for the first value (off 1).
Value Range	0–16000 (0: Infinite time) Note <ul style="list-style-type: none"> Avoid setting 1–50 for any of the values.
Default Value	60,2000,3940
Configuration File Reference	RINGBACK_TONE_TIMING

4.6.5.4 Stutter Tone

Tone Frequencies

Description	Specifies the dual-tone frequencies, in hertz, of stutter dial tones to notify that a voice mail is waiting, using 2 whole numbers separated by a comma.
Value Range	0, 200–2000 (0: No tone) Note <ul style="list-style-type: none"> If the value for this setting is "350,440", the unit will use a mixed signal of a 350 Hz tone and a 440 Hz tone.
Default Value	350,440
Configuration File Reference	DIAL_TONE4_FRQ

Tone Timings

Description	Specifies the pattern, in milliseconds, of stutter dial tones to notify that a voice mail is waiting, using up to 22 whole numbers (off 1, on 1, off 2, on 2...) separated by commas. Note <ul style="list-style-type: none"> It is recommended that you set a value of 560 milliseconds or more for the first value (off 1).
Value Range	0–16000 (0: Infinite time) Note <ul style="list-style-type: none"> Avoid setting 1–50 for any of the values.
Default Value	560,100,100,100,100,100,100,100,100,100,100,100,100,100,100,100,100,100,100,100,0
Configuration File Reference	DIAL_TONE4_TIMING

4.6.5.5 Reorder Tone

Tone Frequencies

Description	Specifies the dual-tone frequencies, in hertz, of reorder tones using 2 whole numbers separated by a comma.
Value Range	0, 200–2000 (0: No tone) Note <ul style="list-style-type: none"> If the value for this setting is "480,620", the unit will use a mixed signal of a 480 Hz tone and a 620 Hz tone.
Default Value	480,620
Configuration File Reference	REORDER_TONE_FRQ

Tone Timings

Description	Specifies the pattern, in milliseconds, of reorder tones using up to 10 whole numbers (off 1, on 1, off 2, on 2...) separated by commas. Note <ul style="list-style-type: none"> It is recommended that you set a value of 60 milliseconds or more for the first value (off 1).
Value Range	0–16000 (0: Infinite time)
Default Value	60,250,190 Note <ul style="list-style-type: none"> Avoid setting 1–50 for any of the values.
Configuration File Reference	REORDER_TONE_TIMING

4.6.6 Import Phonebook

This screen allows you to import phonebook data from a PC to the specified unit. For details, see **6.1.1 Import/Export Operation**.

Note

- If the existing phonebook data has an entry with the same name and phone number as an imported entry, the imported entry is not added as a new entry.
- When you begin transferring the phonebook data, the "Now Processing File Data" screen is displayed, and the screen is periodically reloaded. Depending on your Web browser, the screen might not reload automatically, and you will need to click the text "HERE" before the timer expires in order for the import operation to function properly.

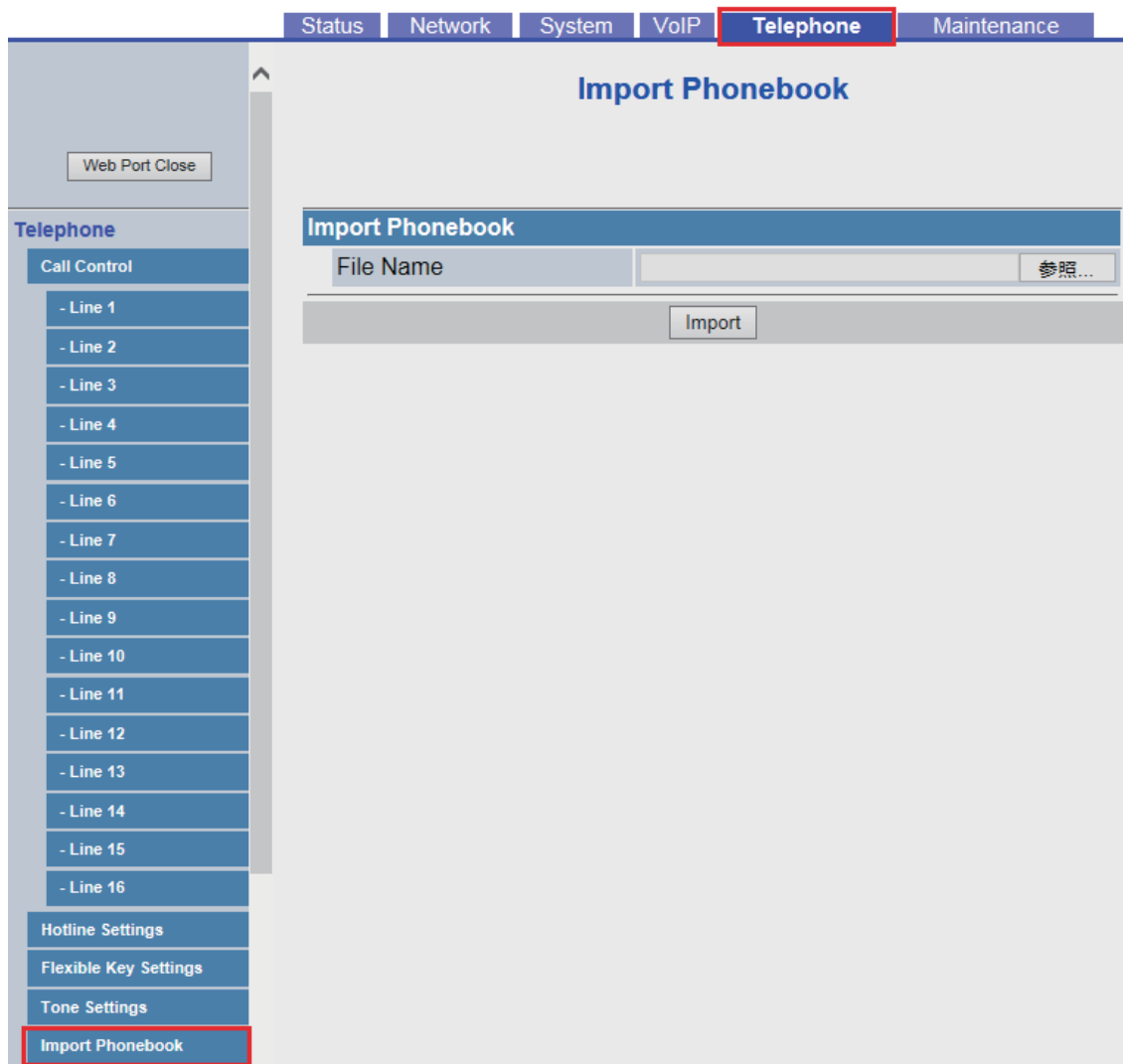

4.6.6.1 Import Phonebook

File Name

Description	Specifies the path of the TSV (Tab-separated Value) file to import from the PC.
Value Range	No limitation Note <ul style="list-style-type: none"> There are no limitations for the field entry. However, it is recommended that paths of less than 256 characters be used: longer paths may cause longer data transfer times and result in an internal error.
Default Value	Not stored.

4.6.7 Export Phonebook

This screen allows you to save the phonebook data stored in the unit as a TSV file on a PC. For details, see **6.1.1 Import/Export Operation**.

Note

- When you begin transferring the phonebook data, the "Now Processing File Data" screen is displayed, and the screen is periodically reloaded. Click the text "HERE" in the message to display the **[Export Phonebook]** screen again. If you do not, the "Now Processing File Data" screen remains displayed even if the export is complete. Depending on your Web browser, the screen might not reload automatically, and you will need to click the text "HERE" before the timer expires in order for the export operation to function properly.
- Depending on the security settings of your Web browser, pop-up menus might be blocked at the time of export. The security warning window may be displayed on another screen even if the Pop-up Blocker settings are set to enable, and the file may not be exported successfully. In this case, try the export operation again or disable the Pop-up Blocker feature of your Web browser.

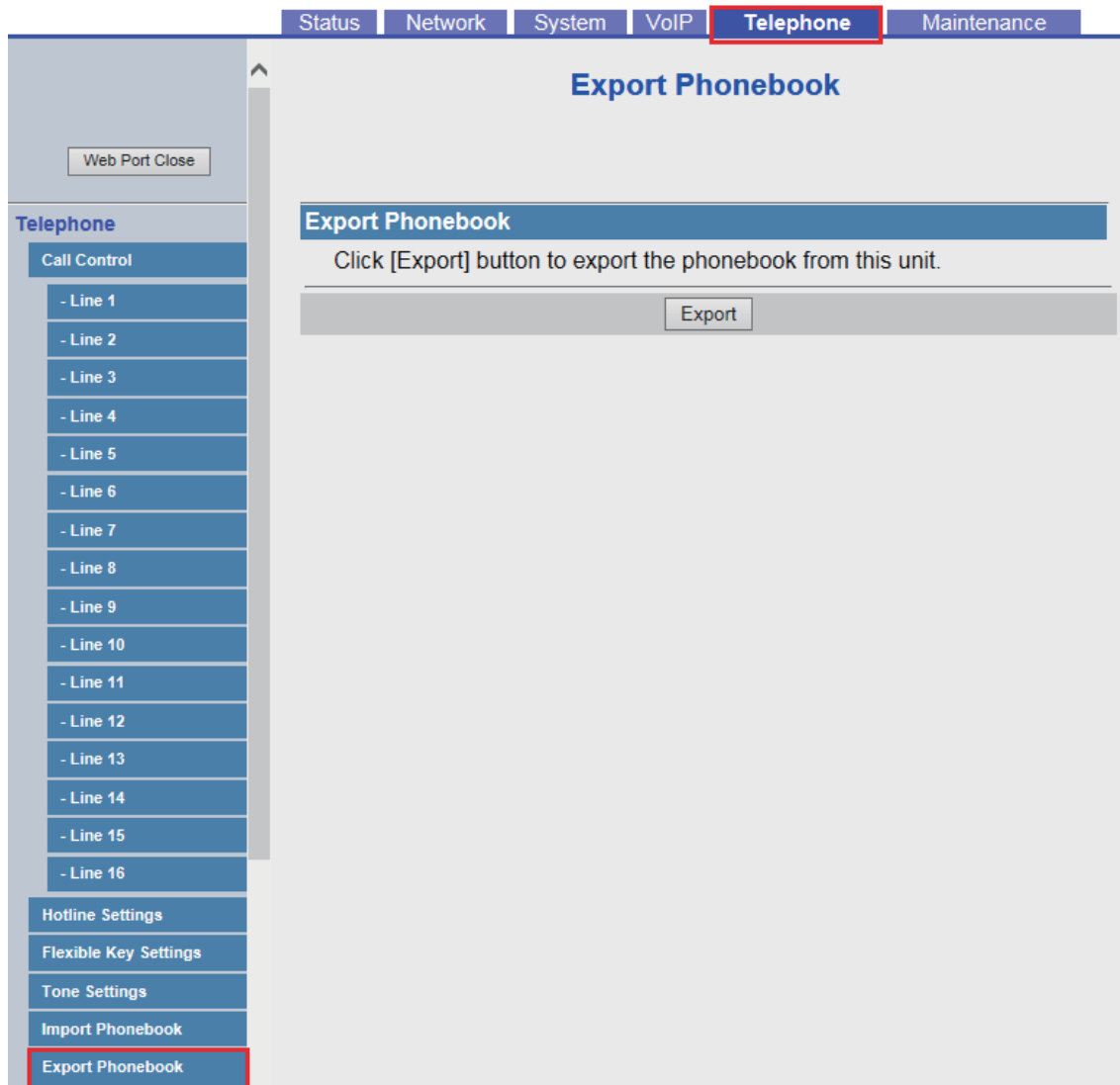

4.6.7.1 Export Phonebook

Export Phonebook

Click [**Export**] button to export the phonebook from this unit.

4.6.8 Video Call Settings

This screen allows you to change the Video Call settings.

4.6.8 Video Call Settings

4.6.8.1 Default Call Mode

Default Call Mode

Description	Selects the default call type when you make a call by going off hook, etc.
Value Range	<ul style="list-style-type: none"> • Voice • Video
Default Value	Voice
Configuration File Reference	DEFAULT_CALL_MODE

4.6.8.2 Screen Mode

Screen Mode

Description	Selects the mode for the video screen.
Value Range	<ul style="list-style-type: none"> • Normal • Split
Default Value	Normal
Configuration File Reference	VIDEO_SCREEN_MODE

4.6.8.3 Send Image

Send Image at Start

Description	Selects whether the video is automatically sent when you start a video call.
Value Range	<ul style="list-style-type: none"> • Yes • No
Default Value	Yes
Configuration File Reference	VIDEO_SEND_IMAGE_ENABLE

4.6.8.4 Rate Settings

Bit Rate

Description	Selects the bit rate for the video when you make a video call.
Value Range	<ul style="list-style-type: none"> • 128 • 256 • 384 • 512 • 768 • 1024 • 2048
Default Value	2048
Configuration File Reference	VIDEO_BIT_RATE

Bit Rate Use

Description	Selects whether the specified bit rate is treated as the maximum bit rate or a fixed bit rate.
Value Range	<ul style="list-style-type: none"> • Maximum • Fixed
Default Value	Maximum
Configuration File Reference	VIDEO_BIT_RATE_USE

Frame Rate

Description	Selects the frame rate for the video when you make a video call.
Value Range	<ul style="list-style-type: none"> • 15 • 30
Default Value	30
Configuration File Reference	VIDEO_FRAME_RATE

Image Size

Description	Selects the size for video images when you make a video call.
Value Range	<ul style="list-style-type: none"> • QCIF • QVGA • CIF • HVGAW • VGA
Default Value	HVGAW
Configuration File Reference	VIDEO_IMAGE_SIZE

4.6.9 DSS Console

This screen allows you to configure various features for each DSS console key. Each DSS console supports 40 keys. DSS console 1 uses keys 1-40, DSS console 2 uses keys 41-80, etc.

Status | Network | System | VoIP | **Telephone** | Maintenance

DSS Console

Web Port Close

Telephone

Call Control

- Line 1
- Line 2
- Line 3
- Line 4
- Line 5
- Line 6
- Line 7
- Line 8
- Line 9
- Line 10
- Line 11
- Line 12
- Line 13
- Line 14
- Line 15
- Line 16

Hotline Settings

Flexible Key Settings

Tone Settings

Import Phonebook

Export Phonebook

Video Call Settings

DSS Console

- DSS Console
- DSS 1 Key (001-020)

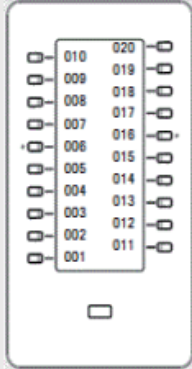

(1)

DSS 1 Key (001-020)			
No.	Type	Parameter	Label Name
001	<input type="text"/>	<input type="text"/>	<input type="text"/>
002	<input type="text"/>	<input type="text"/>	<input type="text"/>
003	<input type="text"/>	<input type="text"/>	<input type="text"/>
004	<input type="text"/>	<input type="text"/>	<input type="text"/>
005	<input type="text"/>	<input type="text"/>	<input type="text"/>
006	<input type="text"/>	<input type="text"/>	<input type="text"/>
007	<input type="text"/>	<input type="text"/>	<input type="text"/>
008	<input type="text"/>	<input type="text"/>	<input type="text"/>
009	<input type="text"/>	<input type="text"/>	<input type="text"/>
010	<input type="text"/>	<input type="text"/>	<input type="text"/>
011	<input type="text"/>	<input type="text"/>	<input type="text"/>
012	<input type="text"/>	<input type="text"/>	<input type="text"/>
013	<input type="text"/>	<input type="text"/>	<input type="text"/>

4.6.9.1 DSS 1-5 Key (No. 1–200)

Type

Description	
	Selects the feature to be assigned to each DSS console key.

Value Range	<ul style="list-style-type: none"> • One Touch Dial • BLF • Line • ACD • Wrap Up • Line Status • Call Forward • Phonebook • Call History • Simultaneous Ring • Hoteling (Hospitality) • Transfer • Blind Transfer • Conference • Directed Call Pickup • Call Park • Call Park Retrieve • Network Camera
Default Value	Not stored.
Configuration File Reference	DSS_BUTTON_FACILITY_ACTx

Parameter

Description	Specifies the necessary values for the features assigned to DSS console keys.
Value Range	Max. 35 characters
Default Value	Not stored.
Configuration File Reference	DSS_BUTTON_FACILITY_ARGx

Label Name

Description	Specifies the message to be displayed on the screen when the DSS console key is pressed.
Value Range	Max. 20 characters
Default Value	Not stored.
Configuration File Reference	DSS_BUTTON_LABELx

4.7 Maintenance

This section provides detailed descriptions about all the settings classified under the **[Maintenance]** tab.

4.7.1 Provisioning Maintenance

This screen allows you to change the provisioning setup to download the configuration files from the provisioning server of your phone system.

4.7.1.1 Provisioning Maintenance

Standard File URL

Description	Specifies the URL of the standard configuration file, which is used when every unit needs different settings.
Value Range	Max. 384 characters Note <ul style="list-style-type: none"> For details about the formats, see 2.1.3 Server Address Formats.
Default Value	Not stored.
Configuration File Reference	CFG_STANDARD_FILE_PATH

Product File URL

Description	Specifies the URL of the product configuration file, which is used when all units with the same model number need the same settings.
Value Range	Max. 384 characters Note <ul style="list-style-type: none"> For details about the formats, see 2.1.3 Server Address Formats.
Default Value	Not stored.
Configuration File Reference	CFG_PRODUCT_FILE_PATH

Master File URL

Description	Specifies the URL of the master configuration file, which is used when all units need the same settings.
Value Range	Max. 384 characters Note <ul style="list-style-type: none"> • For details about the formats, see 2.1.3 Server Address Formats.
Default Value	Not stored.
Configuration File Reference	CFG_MASTER_FILE_PATH

Cyclic Auto Resync

Description	Selects whether the unit periodically checks for updates of configuration files.
Value Range	<ul style="list-style-type: none"> • Yes • No
Default Value	No
Configuration File Reference	CFG_CYCLIC

Resync Interval

Description	Specifies the interval, in minutes, between periodic checks for updates of the configuration files.
Value Range	1–40320
Default Value	10080
Configuration File Reference	CFG_CYCLIC_INTVL

Time Resync

Description	Specifies the time (hour:minute) that the unit checks for updates of configuration files.
Value Range	00:00–23:59
Default Value	Not stored.
Configuration File Reference	CFG_RESYNC_TIME

Header Value for Resync Event

Description	Specifies the value of the "Event" header sent from the SIP server to the unit so that the unit can access the configuration files on the provisioning server.
Value Range	Max. 15 characters
Default Value	check-sync
Configuration File Reference	CFG_RESYNC_FROM_SIP

4.7.2 Firmware Maintenance

This screen allows you to perform firmware updates automatically.

4.7.2.1 Firmware Maintenance

Enable Firmware Update

Description	Selects whether to perform firmware updates when the unit detects a newer version of firmware. Note <ul style="list-style-type: none"> Firmware updates using TR-069 can be performed regardless of this setting.
Value Range	<ul style="list-style-type: none"> Yes No
Default Value	Yes
Configuration File Reference	FIRM_UPGRADE_ENABLE

Firmware File URL

Description	Specifies the URI where the firmware file is stored. Note <ul style="list-style-type: none"> This setting is available only when [Enable Firmware Update] is set to [Yes].
Value Range	Max. 384 characters Note <ul style="list-style-type: none"> If "{fwver}" is included in this parameter, it will be replaced with the value specified in [Firmware Version]. For details about the formats, see 2.1.3 Server Address Formats.
Default Value	Not stored.
Configuration File Reference	FIRM_FILE_PATH

Firmware Version

Description	Specifies the new firmware version of the unit.
Value Range	6 characters xx.xxx [x=0–9]
Default Value	Not stored.
Configuration File Reference	FIRM_VERSION

4.7.3 Export Logging File

This screen allows you to specify the Logging File to export when logging.

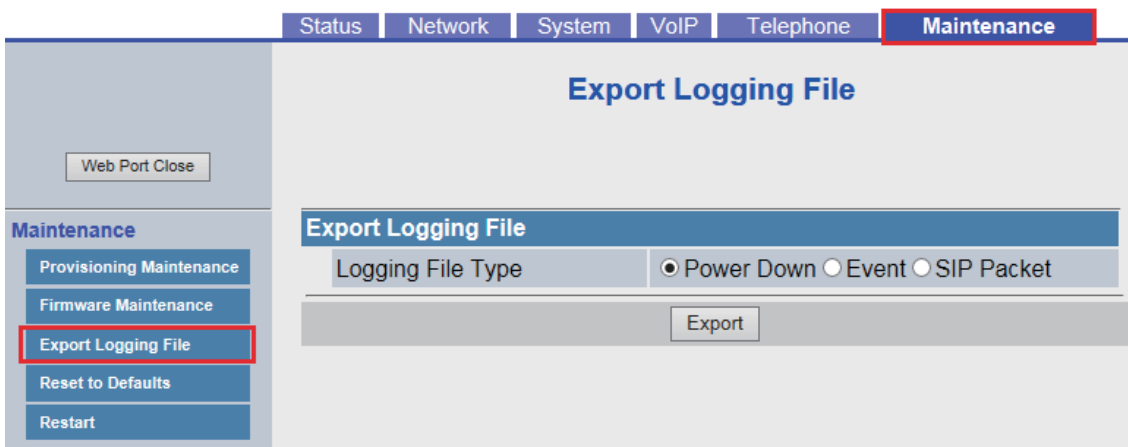

4.7.3.1 Export Logging File

Logging File Type

Description	Selects the Logging File Type setting.
Value Range	<ul style="list-style-type: none"> • Power Down • Event • SIP Packet <p>Note</p> <ul style="list-style-type: none"> • The line break code for the log file is <LF>. • If a file is exported when Power Down is selected, the saved file is power.log. • If a file is exported when Event is selected, the saved file is event_log.txt. • If a file is exported when SIP Packet is selected, the saved file is sip_trace_log.txt.
Default Value	Power Down

4.7.4 Reset to Defaults

This screen allows you to reset the carrier default settings made through the Web user interface to their default values by clicking **[Reset to Carrier Defaults]**. After you click this button, a dialog box is displayed, asking whether you want to reset the settings. Click **OK** to reset, or **Cancel** not to.

Notice

- After resetting the settings, the unit will restart even if it is being accessed through the phone user interface, or on calls.

Note

- You can specify carrier default using configuration parameter extensions. Those parameters will be reset to the specified carrier default values (see **Parameter Extensions**).

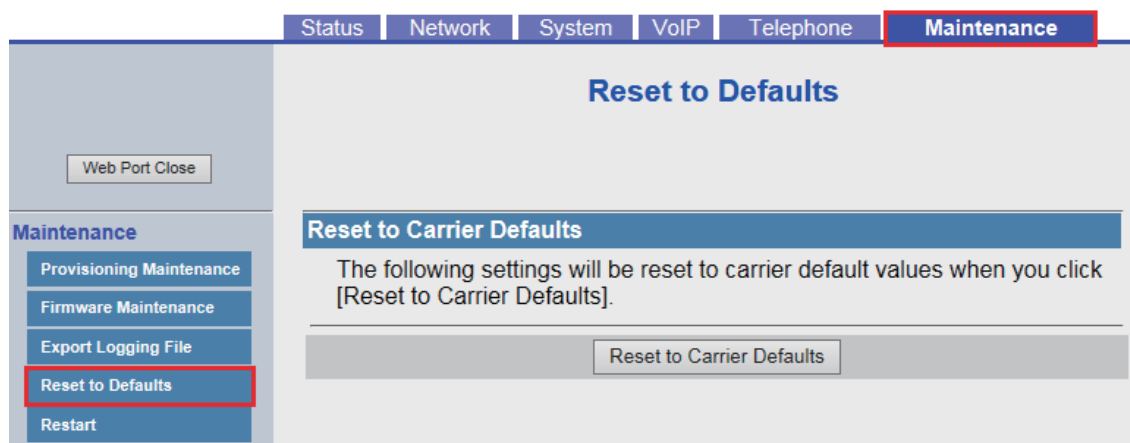

4.7.5 Restart

This screen allows you to restart the unit by clicking **[Restart]**. After you click this button, a dialog box is displayed, asking whether you want to restart the unit. Click **OK** to perform a restart, or **Cancel** not to.

Notice

- The unit will restart even if it is being accessed through the phone user interface, or on calls.

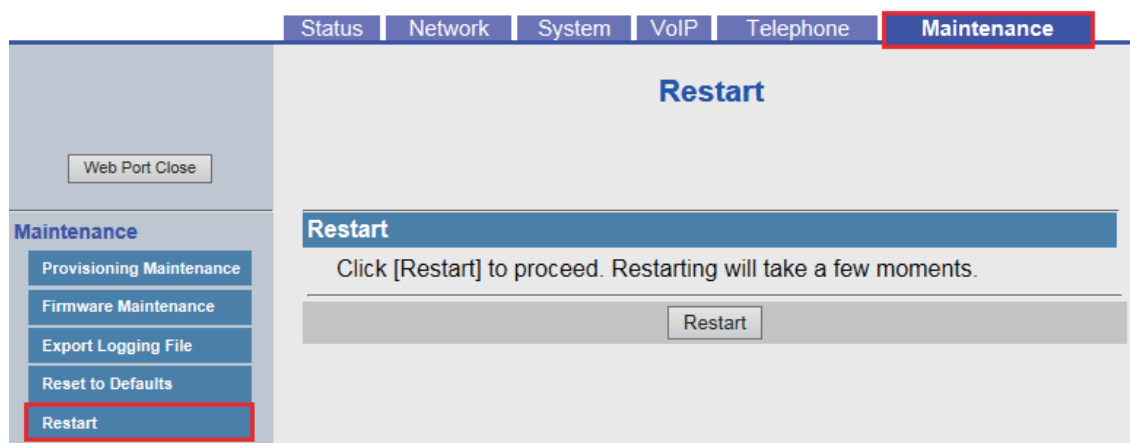

4.7.5 Restart

Section 5

Configuration File Programming

This section provides information about the configuration parameters used in the configuration files.

5.1 Configuration File Parameter List

The following tables show all the parameters that can be programmed using configuration file programming. For details about each parameter, see the reference pages listed.

For details about configuration file specifications, see [2.4 Configuration File Specifications](#).

System Settings

Parameter Name	Ref.
FACTORY_RESET_ENABLE	page 170
BUTTON_LOCATION_SETTING	page 170
SYS_HOME_MENU_ICONx	page 170
FWD_DND_MENU_ENABLE	page 171
BLOCK_ANONY_MENU_ENABLE	page 171
ANONY_CALL_MENU_ENABLE	page 171
TIME_ZONE_SET_ENABLE	page 172
DISPLAY_CALL_KEY_ENABLE	page 172

Basic Network Settings

Parameter Name	Ref.
IP_ADDR_MODE ¹	page 172
CONNECTION_TYPE ¹	page 172
STATIC_IP_ADDRESS ¹	page 172
STATIC_SUBNET ¹	page 173
STATIC_GATEWAY ¹	page 173
USER_DNS1_ADDR ¹	page 173
USER_DNS2_ADDR ¹	page 174
DHCP_DNS_ENABLE ¹	page 174
DHCP_HOST_NAME ²	page 174
DHCP_VENDOR_CLASS	page 175
CONNECTION_TYPE_IPV6 ¹	page 175
STATIC_IP_ADDRESS_IPV6 ¹	page 175
PREFIX_IPV6 ¹	page 175
STATIC_GATEWAY_IPV6 ¹	page 176
USER_DNS1_ADDR_IPV6 ¹	page 176
USER_DNS2_ADDR_IPV6 ¹	page 176
DHCP_DNS_ENABLE_IPV6 ¹	page 176

Ethernet Port Settings

Parameter Name	Ref.
PHY_MODE_LAN ¹	page 176
PHY_MODE_PC ¹	page 177
VLAN_ENABLE ¹	page 177
VLAN_ID_IP_PHONE ¹	page 177
VLAN_PRI_IP_PHONE ¹	page 178
VLAN_ID_PC ¹	page 178
VLAN_PRI_PC ¹	page 178
LLDP_ENABLE ¹	page 178
LLDP_INTERVAL ²	page 179
LLDP_VLAN_ID_PC ¹	page 179
LLDP_VLAN_PRI_PC ¹	page 179

Pre-Provisioning Settings

Parameter Name	Ref.
SIPPNP_PROV_ENABLE	page 179
OPTION66_ENABLE	page 179
OPTION159_PROV_ENABLE	page 180
OPTION160_PROV_ENABLE	page 180
DHCPV6_OPTION17_PROV_ENABLE	page 180

Provisioning Settings

Parameter Name	Ref.
CFG_STANDARD_FILE_PATH ²	page 180
CFG_PRODUCT_FILE_PATH ²	page 181
CFG_MASTER_FILE_PATH ²	page 181
CFG_CYCLIC ²	page 182
CFG_CYCLIC_INTVL ²	page 182
CFG_RESYNC_TIME ²	page 182
CFG_RTRY_INTVL	page 182
CFG_RESYNC_FROM_SIP ²	page 183
CFG_RESYNC_ACTION	page 183
CFG_FILE_KEY2	page 183
CFG_FILE_KEY3	page 183
CFG_FILE_KEY_LENGTH	page 184

5.1 Configuration File Parameter List

Parameter Name	Ref.
CFG_ROOT_CERTIFICATE_PATH	page 184
CFG_CLIENT_CERT_PATH	page 184
CFG_PKEY_PATH	page 184
HTTP_SSL_VERIFY	page 185
CFG_RESYNC_DURATION	page 185

Firmware Update Settings

Parameter Name	Ref.
FIRM_UPGRADE_ENABLE ²	page 185
FIRM_FILE_PATH ²	page 186
FIRM_VERSION	page 186
FWDL_RANDOM_DURATION	page 186

HTTP Settings

Parameter Name	Ref.
HTTP_VER ²	page 187
HTTP_USER_AGENT ²	page 187
HTTP_AUTH_ID ¹	page 187
HTTP_AUTH_PASS ¹	page 188
HTTP_PROXY_ENABLE ²	page 188
HTTP_PROXY_ADDR ²	page 188
HTTP_PROXY_PORT ²	page 188
HTTP_PROXY_ID	page 188
HTTP_PROXY_PASS	page 188

HTTPD/WEB Settings

Parameter Name	Ref.
HTTPD_LISTEN_PORT	page 189
HTTPD_PORTOPEN_AUTO	page 189
HTTPD_PORTCLOSE_TM	page 189
USER_ID	page 189
USER_PASS ²	page 190
ADMIN_ID	page 190
ADMIN_PASS ²	page 190

TR-069 Settings

Parameter Name	Ref.
ACS_URL	page 191
ACS_USER_ID	page 191
ACS_PASS	page 191
PERIODIC_INFORM_ENABLE	page 191
PERIODIC_INFORM_INTERVAL	page 192
PERIODIC_INFORM_TIME	page 192
CON_REQ_USER_ID	page 192
CON_REQ_PASS	page 193
ANNEX_G_STUN_ENABLE	page 193
ANNEX_G_STUN_SERV_ADDR	page 193
ANNEX_G_STUN_SERV_PORT	page 193
ANNEX_G_STUN_USER_ID	page 194
ANNEX_G_STUN_PASS	page 194
ANNEX_G_STUN_MAX_KEEP_ALIVE	page 194
ANNEX_G_STUN_MIN_KEEP_ALIVE	page 195
UDP_CON_REQ_ADDR_NOTIFY_LIMIT	page 195
DEVICE_PROVISIONING_CODE	page 195

XML Settings

Parameter Name	Ref.
XMLAPP_ENABLE ²	page 195
XMLAPP_USERID ²	page 195
XMLAPP_USERPASS ²	page 196
XMLAPP_LDAP_URL ²	page 196
XMLAPP_LDAP_USERID ²	page 196
XMLAPP_LDAP_USERPASS ²	page 196
XMLAPP_NPB_SEARCH_TIMER	page 196
XMLAPP_LDAP_MAXRECORD ²	page 197
XML_HTTPD_PORT ²	page 197
XML_ERROR_INFORMATION	page 197
XMLAPP_START_URL ²	page 197
XMLAPP_INITIAL_URL ²	page 197
XMLAPP_INCOMING_URL ²	page 198
XMLAPP_TALKING_URL ²	page 198

5.1 Configuration File Parameter List

Parameter Name	Ref.
XMLAPP_MAKECALL_URL ²	page 198
XMLAPP_CALLLOG_URL ²	page 198
XMLAPP_IDLING_URL ²	page 198
XMLAPP_FFKEY_ENABLE ²	page 199
XMLAPP_STATUSBAR_ENABLE	page 199
XMLAPP_URL_FLEX_BUTTONx	page 199
SYS_HOME_MENU_XML_NAMEx	page 199
SYS_HOME_MENU_XML_URLx	page 199
SYS_HOME_MENU_XML_ICONx	page 200

XSI Settings

Parameter Name	Ref.
XSI_ENABLE ²	page 200
XSI_SERVER ²	page 200
XSI_SERVER_TYPE ²	page 201
XSI_SERVER_PORT ²	page 201
XSI_USERID_n ¹	page 201
XSI_PASSWORD_n ¹	page 201
XSI_PHONEBOOK_ENABLE_n ²	page 201
XSI_PHONEBOOK_CYCLIC_INTVL	page 202
XSI_PHONEBOOK_RESYNC_DURATION	page 202
XSI_PHONEBOOK_TYPE_n ²	page 202
XSI_CALLLOG_ENABLE_n ²	page 202
XSI_VISUAL_VM_ENABLE_n ²	page 203
XSI_SIP_CREDENTIALS_ENABLE ²	page 203
BSD_MULTI_TYPE_ENABLE	page 203
BSD_GROUP_ENABLE_n	page 203
BSD_GROUPCOM_ENABLE_n	page 204
BSD_ENTERPRISE_ENABLE_n	page 204
BSD_ENTERPRISECOM_ENABLE_n	page 204
BSD_PERSONAL_ENABLE_n	page 204

XMPP (UC-ONE) Settings

Parameter Name	Ref.
UC_ENABLE ²	page 205

Parameter Name	Ref.
UC_USERID ^{*1}	page 205
UC_PASSWORD ^{*1}	page 205
XMPP_SERVER ^{*2}	page 205
XMPP_PORT ^{*2}	page 205
XMPP_TLS_VERIFY	page 206
XMPP_ROOT_CERT_PATH	page 206
XMPP_CLIENT_CERT_PATH	page 206
XMPP_PKEY_PATH	page 206
UC_DNSSRV_ENA	page 207
UC_TCP_SRV_PREFIX	page 207
UC_USERID_CASE_SENSITIVE	page 207

LDAP Settings

Parameter Name	Ref.
LDAP_ENABLE ^{*2}	page 207
LDAP_DNSSRV_ENABLE ^{*2}	page 207
LDAP_SERVER ^{*2}	page 208
LDAP_SERVER_PORT ^{*2}	page 208
LDAP_MAXRECORD ^{*2}	page 208
LDAP_NUMB_SEARCH_TIMER	page 208
LDAP_NAME_SEARCH_TIMER	page 208
LDAP_USERID ^{*2}	page 208
LDAP_PASSWORD ^{*2}	page 209
LDAP_NAME_FILTER ^{*2}	page 209
LDAP_NUMB_FILTER ^{*2}	page 209
LDAP_NAME_ATTRIBUTE ^{*2}	page 209
LDAP_NUMB_ATTRIBUTE ^{*2}	page 209
LDAP_BASEDN ^{*2}	page 210
LDAP_SSL_VERIFY	page 210
LDAP_ROOT_CERT_PATH	page 210
LDAP_CLIENT_CERT_PATH	page 210
LDAP_PKEY_PATH	page 210
LDAP_DISPLAY_FORMAT	page 211

Call Center Settings

Parameter Name	Ref.
CALL_CENTER_ENABLE_n ²	page 211
ACD_ENABLE_n ²	page 211
ACD_LOGIN_CONDITION_n	page 211
ACD_LOGOUT_CONDITION_n	page 212
CC_DISPOSITION_CODE_ENABLE_n ²	page 212
CC_CUSTOMER_ORG_TRACE_ENABLE_n ²	page 212
CC_HOTELING_EVENT_n ²	page 212
HOTELING_USERID_n ²	page 213
HOTELING_PASSWORD_n ²	page 213
CC_STATUS_EVENT_ENABLE_n ²	page 213

SNMP Settings

Parameter Name	Ref.
SNMP_ENABLE	page 214
SNMP_TRUST_IP	page 214
SNMP_TRUST_PORT	page 214
SNMP_RO_COMMUNITY_STRING	page 214
SNMP_SECURITY_TYPE	page 214
SNMP_SECURITY_USER	page 214
SNMP_AUTH_TYPE	page 215
SNMP_AUTH_PASSWORD	page 215
SNMP_ENCRYPT_TYPE	page 215
SNMP_ENCRYPT_PASSWORD	page 215

Multicast Paging Settings

Parameter Name	Ref.
MPAGE_ADDRm ²	page 215
MPAGE_IPV6_ADDRm ²	page 216
MPAGE_PORTm ²	page 216
MPAGE_PRIORITYm ²	page 216
MPAGE_LABELm ²	page 216
MPAGE_SEND_ENABLEm ²	page 217
MPAGE_CODEC	page 217
MPAGE_SP_VOL_EMERGENCY	page 217

Parameter Name	Ref.
MPAGE_SP_VOL_PRIORITY	page 217
MPAGE_DND_ENABLE	page 217
MPAGE_FUNCKEY_ENABLE	page 218

NTP Settings

Parameter Name	Ref.
NTP_ADDR ²	page 218
TIME_SYNC_INTVL	page 218
TIME_QUERY_INTVL ²	page 218

Time Settings

Parameter Name	Ref.
LOCAL_TIME_ZONE_POSIX	page 218
TIME_ZONE ²	page 219
DST_ENABLE ²	page 220
DST_OFFSET ²	page 220
DST_START_MONTH ²	page 221
DST_START_ORDINAL_DAY ²	page 221
DST_START_DAY_OF_WEEK ²	page 221
DST_START_TIME ²	page 222
DST_STOP_MONTH ²	page 222
DST_STOP_ORDINAL_DAY ²	page 222
DST_STOP_DAY_OF_WEEK ²	page 223
DST_STOP_TIME ²	page 223

Network Phonebook (Common)

Parameter Name	Ref.
ONLY_NPB_ENABLE	page 224
NETWORK_SEARCH_ENABLE	page 224

Language Settings

Parameter Name	Ref.
AVAILABLE_LANGUAGE ²	page 224
DEFAULT_LANGUAGE ²	page 224
LANGUAGE_PATH _x	page 225
LANGUAGE_VER _x	page 225

5.1 Configuration File Parameter List

Parameter Name	Ref.
AVAILABLE_LANGUAGE_WEB ²	page 225
WEB_LANGUAGE ²	page 225
WEB_LANGUAGE_PATHx	page 226
WEB_LANGUAGE_VERx	page 226

NAT Settings

Parameter Name	Ref.
STUN_SERV_ADDR ²	page 226
STUN_SERV_PORT ²	page 226
STUN_2NDSERV_ADDR	page 226
STUN_2NDSERV_PORT	page 227
STUN_INTVL ²	page 227
SIP_ADD_RPORT ²	page 227
PORT_PUNCH_INTVL ²	page 227
RTP_PORT_PUNCH_INTVL ²	page 227
EXTERNAL_RTP_PORTx	page 228

SIP Settings

Parameter Name	Ref.
SIP_USER_AGENT ²	page 228
PHONE_NUMBER_n ²	page 228
SIP_URI_n ²	page 229
SIP_RGSTR_ADDR_n ²	page 229
SIP_RGSTR_PORT_n ²	page 229
SIP_PRXY_ADDR_n ²	page 230
SIP_PRXY_PORT_n ²	page 230
SIP_PRSNC_ADDR_n ²	page 230
SIP_PRSNC_PORT_n ²	page 230
SIP_OUTPROXY_ADDR_n ²	page 231
SIP_OUTPROXY_PORT_n ²	page 231
SIP_SVCDOMAIN_n ²	page 231
SIP_AUTHID_n ²	page 231
SIP_PASS_n ²	page 231
SIP_SRC_PORT_n ²	page 232
DSCP_SIP_n ²	page 232

Parameter Name	Ref.
SIP_DNSSRV_ENA_n ²	page 233
SIP_UDP_SRV_PREFIX_n ²	page 233
SIP_TCP_SRV_PREFIX_n ²	page 233
REG_EXPIRE_TIME_n ²	page 234
REG_INTERVAL_RATE_n	page 234
REG_RTX_INTVL_n	page 234
USE_DEL_REG_OPEN_n	page 234
USE_DEL_REG_CLOSE_n	page 235
SIP_SESSION_TIME_n ²	page 235
SIP_SESSION_METHOD_n ²	page 235
SIP_TIMER_T1_n ²	page 235
SIP_TIMER_T2_n ²	page 236
SIP_TIMER_T4_n	page 236
SIP_TIMER_B_n	page 236
SIP_TIMER_D_n	page 237
SIP_TIMER_F_n	page 237
SIP_TIMER_H_n	page 237
SIP_TIMER_J_n	page 237
SIP_100REL_ENABLE_n ²	page 238
SIP_18X_RTX_INTVL_n	page 238
SIP_SUBS_EXPIRE_n	page 238
SUB_INTERVAL_RATE_n	page 238
SUB_RTX_INTVL_n	page 239
SIP_P_PREFERRED_ID_n	page 239
SIP_PRIVACY_n	page 239
ADD_USER_PHONE_n	page 239
SIP_ANM_DISPNAME_n	page 240
SIP_ANM_USERNAME_n	page 240
SIP_ANM_HOSTNAME_n	page 240
SIP_DETECT_SSAF_n ²	page 241
SIP_RCV_DET_HEADER_n	page 241
SIP_RCV_DET_REQURI_n	page 241
SIP_CONTACT_ON_ACK_n	page 242
VOICE_MESSAGE_AVAILABLE	page 242
SIP_INVITE_EXPIRE_n	page 242

5.1 Configuration File Parameter List

Parameter Name	Ref.
SIP_FOVR_NORSP_n	page 242
SIP_FOVR_MAX_n	page 243
SIP_FOVR_MODE_n	page 243
SIP_FOVR_DURATION_n	page 243
SIP_ADD_ROUTE_n	page 243
SIP_REQUIRE_PORT_n	page 244
ADD_EXPIRES_HEADER_n	page 244
ADD_TRANSPORT_UDP_n	page 244
SIP_ADD_DIVERSION_n	page 245
TRANSFER_RECALL_TIM	page 245
SIGNAL_COMPRESSION_n	page 245
MAX_BREADTH_n	page 245
MUTIPART_BOUNDARY_DELIMITER_n	page 246
RFC5626_KEEPALIVE_ENABLE_n	page 246
RINGTONE_183_180_ENABLE_n	page 246
SIP_403_REG_SUB_RTX_n	page 246
SIP_FORK_MODE_n	page 247
AKA_AUTHENTICATION_ENABLE_n	page 247
RFC2543_HOLD_ENABLE_n ²	page 247
SIP_HOLD_ATTRIBUTE_n	page 247
SDP_USER_ID_n	page 248
TELEVENT_PAYLOAD ²	page 248
HOLD_SOUND_PATH_n	page 248
KEEP_EARLYMEDIA_n	page 249
RFC3327_SUPPORT_PATH	page 249
RFC4244_SUPPORT_HISTORY	page 249
RFC3319_SUPPORT_JOIN	page 249
RFC6947_DRAFT08_ALTC	page 249
RFC5627_SUPPORT_GUU_n	page 250
ESCAPECODE_CONVERSION	page 250
SIP_REPLACE_ENABLE_n	page 250
SIP_INC_INVITE_RTP_MODE_n	page 250

SIP-TLS Settings

Parameter Name	Ref.
SIP_TRANSPORT_n ²	page 251
SIP_TLS_MODE_n ²	page 251
SIP_TLS_RECONNECT_n	page 251
SIP_TLS_SRV_PREFIX_n ²	page 251
SIP_TLS_VERIFY_n	page 252
SIP_TLS_ROOT_CERT_PATH	page 252
SIP_TLS_CLIENT_CERT_PATH	page 252
SIP_TLS_PKEY_PATH	page 252
SIP_TLS_RANDOM_PORT	page 253

CODEC Settings

Parameter Name	Ref.
CODEC_G729_PARAM_n	page 253
CODEC_ENABLEx_n ²	page 253
CODEC_PRIORITYx_n ²	page 254
CODEC_G711_REQ	page 254

DTMF Settings

Parameter Name	Ref.
DTMF_METHOD_n ²	page 254
OUTBANDDTMF_VOL	page 255
INBANDDTMF_VOL	page 255
DTMF_SIGNAL_LEN	page 255
DTMF_INTDIGIT_TIM	page 255

RTP/RTCP/RTCP-XR Settings

Parameter Name	Ref.
DSCP_RTP_n ²	page 256
DSCP_RTCP_n ²	page 256
MAX_DELAY_n	page 256
MIN_DELAY_n	page 256
NOM_DELAY_n	page 257
RTP_PORT_MIN ²	page 257
RTP_PORT_MAX ²	page 257
RTP_PTIME ²	page 257

5.1 Configuration File Parameter List

Parameter Name	Ref.
RTP_TARGET_CHECK	page 258
RTCP_ENABLE_n ²	page 258
RTCP_INTVL_n ²	page 258
RTCP_SEND_BY_SDP_n	page 258
RTP_CLOSE_ENABLE_n	page 259
RTCPXR_ENABLE_n ²	page 259

SRTP Settings

Parameter Name	Ref.
SRTP_CONNECT_MODE_n ²	page 259
SRTP_MIX_CONFERENCE_ENABLE_n ²	page 260
SRTP_MIX_TRANSFER_ENABLE_n ²	page 260
SRTP_HELD_CALL_RTP_ENABLE	page 260

VQ Report by PUBLISH

Parameter Name	Ref.
VQREPORT_COLLECTOR_ADDRESS ²	page 261
VQREPORT_COLLECTOR_PORT ²	page 261
VQREPORT_SEND ²	page 261
ALERT_REPORT_TRIGGER ²	page 261
ALERT_REPORT_MOSQ_CRITICAL ²	page 262
ALERT_REPORT_MOSQ_WARNING ²	page 262
ALERT_REPORT_DELAY_CRITICAL ²	page 262
ALERT_REPORT_DELAY_WARNING ²	page 262
VQREPORT_SIGNAL_COMPRESSION	page 262

uaCSTA Settings

Parameter Name	Ref.
UACSTA_ENABLE_n	page 263
UACSTA_UNIQUE_ID	page 263
CSTA_PORT	page 263
CSTA_PRXY_ADDR	page 263
CSTA_PRXY_PORT	page 263
CSTA_RGSTR_ADDR	page 263
CSTA_RGSTR_PORT	page 264
CSTA_REG_EXPIRE_TIME	page 264

Parameter Name	Ref.
CSTA_TRANSPORT	page 264
CSTA_RGSTR_AUTHID	page 264
CSTA_RGSTR_PASS	page 264

Telephone Settings

Parameter Name	Ref.
POWER_ON_DISPLAY_LOGO_PATH	page 265
FIRSTDIGIT_TIM ²	page 265
INTDIGIT_TIM ²	page 265
POUND_KEY_DELIMITER_ENABLE ²	page 265
RINGTONE_SETTING_n ³	page 266
DISPLAY_NAME_REPLACE	page 266
NUMBER_MATCHING_LOWER_DIGIT	page 266
NUMBER_MATCHING_UPPER_DIGIT	page 266
FLASH_RECALL_TERMINATE	page 266
FLASHHOOK_CONTENT_TYPE	page 267
NUM_PLAN_PARKING ²	page 267
CALLPARK_KEY_ENABLE ²	page 267
NUM_PLAN_PARK_RETRIEVING ²	page 267
HOLD_RECALL_TIM	page 267
HOLD_TRANSFER_OPERATION	page 268
ONHOOK_TRANSFER_ENABLE	page 268
ONHOOK_HOLD_TRNS_ENABLE	page 268
BLIND_TRANSFER_ENABLE	page 268
SYS_LOCK_ENABLE ²	page 268
SYS_LOCK_PASSWORD ²	page 269
PAUSE_INPUT_ENABLE	page 269
NUM_PLAN_PICKUP_DIRECT ²	page 269
DISP_NUM_PHONEBOOK_ENABLE	page 269
WALLPAPER_WAIT_TIME ¹	page 269
CNIP_FROM_ENABLE	page 270
IDLE_DISPLAY_TYPE ³	page 270
BLE_DISPLAY_OFF_OUTGOING	page 270
SPLIT_HOLD_TRNS_ENABLE	page 270

Flexible Key Settings

Parameter Name	Ref.
FLEX_BUTTON_FACILITY_ACTx ²	page 271
FLEX_BUTTON_FACILITY_ARGx ²	page 271
FLEX_BUTTON_LABELx ²	page 272
FLEX_BUTTON_QUICK_DIALx	page 272
LONG_PRESS_KEY_SETTING_ENABLE	page 272

DSS Key Settings

Parameter Name	Ref.
DSS_BUTTON_FACILITY_ACTx ²	page 273
DSS_BUTTON_FACILITY_ARGx ²	page 273
DSS_BUTTON_LABELx ²	page 274
DSS_BUTTON_QUICK_DIALx	page 274

Tone Settings

Parameter Name	Ref.
OUTSIDE_DIAL_TONE_FRQ	page 274
OUTSIDE_DIAL_TONE_GAIN	page 274
OUTSIDE_DIAL_TONE_RPT	page 274
OUTSIDE_DIAL_TONE_TIMING	page 275
CONFIRMATION_TONE5_FRQ	page 275
CONFIRMATION_TONE5_GAIN	page 275
REORDER_TONE_ENABLE	page 275
TONE_LEN_DISCONNECT	page 275
DIAL_TONE1_FRQ ²	page 276
DIAL_TONE1_GAIN	page 276
DIAL_TONE1_RPT	page 276
DIAL_TONE1_TIMING ²	page 276
DIAL_TONE2_FRQ	page 276
DIAL_TONE2_GAIN	page 277
DIAL_TONE2_RPT	page 277
DIAL_TONE2_TIMING	page 277
DIAL_TONE4_FRQ	page 277
DIAL_TONE4_GAIN	page 277
DIAL_TONE4_RPT	page 278
DIAL_TONE4_TIMING	page 278

Parameter Name	Ref.
BUSY_TONE_FRQ ²	page 278
BUSY_TONE_GAIN	page 278
BUSY_TONE_RPT	page 279
BUSY_TONE_TIMING	page 279
REORDER_TONE_FRQ ²	page 279
REORDER_TONE_GAIN	page 279
REORDER_TONE_RPT	page 279
REORDER_TONE_TIMING ²	page 280
RINGBACK_TONE_FRQ ²	page 280
RINGBACK_TONE_GAIN	page 280
RINGBACK_TONE_RPT	page 280
RINGBACK_TONE_TIMING ²	page 281
HOLD_ALARM_FRQ	page 281
HOLD_ALARM_GAIN	page 281
CW_TONE1_FRQ	page 281
CW_TONE1_GAIN	page 281
HOLD_TONE_FRQ	page 282
HOLD_TONE_GAIN	page 282
BELL_CORE_PATTERN1_TIMING	page 282
BELL_CORE_PATTERN2_TIMING	page 282
BELL_CORE_PATTERN3_TIMING	page 282
BELL_CORE_PATTERN4_TIMING	page 283
BELL_CORE_PATTERN5_TIMING	page 283
KEY_PAD_TONE	page 283

Call Control Settings

Parameter Name	Ref.
DEFAULT_LINE_SELECT ¹	page 284
ANONYMOUS_CALL_ENABLE_n ¹	page 284
BLOCK_ANONYMOUS_CALL_ENABLE_n ¹	page 285
HOTLINE_ENABLE ²	page 285
HOTLINE_NUMBER ²	page 285
HOTLINE_TIM ²	page 285
DISPLAY_NAME_n ²	page 285
VM_SUBSCRIBE_ENABLE ²	page 286

5.1 Configuration File Parameter List

Parameter Name	Ref.
VM_NUMBER_n ²	page 286
VM_SUBSCRIBE_SPECIFIC_n	page 286
DIAL_PLAN_n ²	page 286
DIAL_PLAN_NOT_MATCH_ENABLE_n ²	page 287
MACRODIGIT_TIM ²	page 287
INTERNATIONAL_ACCESS_CODE ²	page 287
COUNTRY_CALLING_CODE ²	page 288
NATIONAL_ACCESS_CODE ²	page 288
ADMIN_ABILITY_ENABLE ²	page 288
EMERGENCY_CALLx ²	page 288
CALL_REJECTIONx ¹	page 289
CLICKTO_ENABLE_n ²	page 289
CALLPARK_NOTIFICATION_ENABLE_n ²	page 289
SHARED_CALL_ENABLE_n ²	page 289
SHARED_STOP_LINE_SEIZE ²	page 290
FWD_DND_SYNCHRO_ENABLE_n ²	page 290
FWD_SYNCHRO_FORCE_DISABLE_n	page 291
CONF_SERVER_HOLD_ENABLE	page 291
MOH_SERVER_URI_n ²	page 291
BS_EXECUTIVE_SETTING_ENABLE_n ²	page 291
BS_ASSISTANT_SETTING_ENABLE_n ²	page 292
FWD_DND_CONTROL_ENABLE	page 292
FWD_DND_SYNCHRO_MODE	page 292
HOLD_AND_CALL_ENABLE	page 292
AUTO_CALL_HOLD	page 292
SIP_RESPONSE_CODE_DND	page 293
SIP_RESPONSE_CODE_CALL_REJECT	page 293
CW_ENABLE_n ²	page 293
RETURN_VOL_SET_DEFAULT_ENABLE	page 293
CONFERENCE_SERVER_URI ²	page 293
RESOURCELIST_URI_n ²	page 294

Video Communication Settings

Parameter Name	Ref.
DEFAULT_CALL_MODE ¹	page 294

Parameter Name	Ref.
VIDEO_SCREEN_MODE ¹	page 294
VIDEO_SEND_IMAGE_ENABLE ¹	page 294
VIDEO_BIT_RATE ¹	page 295
VIDEO_BIT_RATE_USE ¹	page 295
VIDEO_FRAME_RATE ¹	page 295
VIDEO_IMAGE_SIZE ¹	page 295
H264_PAYLOAD	page 296

Network Camera Settings

Parameter Name	Ref.
NWCAMERA_DISPLAY_NAME ^{x3}	page 296
NWCAMERA_ADDR ^{x3}	page 296
NWCAMERA_PORT ^{x3}	page 296
NWCAMERA_USER_ID ^{x3}	page 297
NWCAMERA_PASS ^{x3}	page 297
NWCAMERA_PAGING_PHONE_NAME ^{x3}	page 297
NWCAMERA_PAGING_PHONE_NUMBER ^{x3}	page 297
NWCAMERA_LINK_PHONE _m NAME ^{x3}	page 298
NWCAMERA_LINK_PHONE _m NUMBER ^{x3}	page 298
NWCAMERA_STREAM ^{x3}	page 298
NWCAMERA_ALARM_NOTIFICATION ³	page 298
NWCAMERA_ALARM_DISARM_TIME ³	page 299
NWCAMERA_ALARM_PORT ³	page 299

Communication Camera Settings

Parameter Name	Ref.
COMM_CAMERA_NUMBER ^{x2}	page 299
COMM_CAMERA_NAME ^{x2}	page 299
COMM_CAMERA_RINGTONE_SETTING ^{x2}	page 299
DTMF_CONTROL_UP_CAMERA _x	page 300
DTMF_CONTROL_DOWN_CAMERA _x	page 300
DTMF_CONTROL_LEFT_CAMERA _x	page 300
DTMF_CONTROL_RIGHT_CAMERA _x	page 300
DTMF_CONTROL_OPEN_CAMERA _x	page 301
DTMF_CONTROL_ZOOMUP_CAMERA _x	page 301

5.2 General Information on the Configuration Files

Parameter Name	Ref.
DTMF_CONTROL_ZOOMDOWN_CAMERA x	page 301
DTMF_CONTROL_VOICE_CAMERA x	page 301

Logging Settings

Parameter Name	Ref.
SYSLOG_ADDR	page 302
SYSLOG_PORT	page 302
LOGGING_LEVEL_DNS	page 302
LOGGING_LEVEL_NW1	page 302
LOGGING_LEVEL_FILE	page 302
LOGGING_LEVEL_SIP	page 302
LOGGING_LEVEL_TR069	page 303
LOGGING_LEVEL_STUN	page 303
LOGGING_LEVEL_NW2	page 303
LOGGING_LEVEL_CFGPARSE	page 303

^{*1} This setting can also be configured through other programming methods (phone user interface programming or Web user interface programming).

^{*2} This setting can also be configured through the Web user interface.

^{*3} This setting can also be configured through the Phone user interface programming.

5.2 General Information on the Configuration Files

5.2.1 Configuration File Parameters

The information on each parameter that can be written in a configuration file is shown in the tables below. The information includes parameter name (as the title of the table), value format, description, permitted value range, default value of each parameter, phone user interface reference, and Web user interface reference.

Parameter Name

This is the system-predefined parameter name and cannot be changed.

Note

- Certain parameter names end with "n". This signifies that these settings can be made to each line individually. The number of lines available varies depending on the phone being used, as follows:
 - KX-HDV430: 1–16

Value Format

Each parameter value is categorized into Integer, Boolean, or String. Some parameters require a composite form such as "Comma-separated Integer" or "Comma-separated String".

- **Integer:** a numerical value, described as a sequence of numerical characters, optionally preceded by a "-" (minus)
An empty string is not allowed.

- **Boolean:** "Y" or "N"
- **String:** sequence of alphanumerical characters
For details about available characters, see **5.2.2 Characters Available for String Values**.
- **Comma-separated Integer:** a list of integers, separated by commas
No space characters are allowed.
- **Comma-separated String:** a list of strings, separated by commas
No space characters are allowed.
- **IPADDR:** IPv4 address format.
- **IPADDR-V6:** IPv6 address format (can be abbreviated).

Description

Describes the details of the parameter.

Value Range

Indicates the permitted value range of the parameter.

Default Value

Indicates the factory default value of the parameter.

Actual default values may vary depending on your phone system dealer/service provider.

Phone User Interface Reference

Provides the reference page of the corresponding parameter in phone user interface programming.

Web User Interface Reference

Provides the reference page of the corresponding parameter in Web user interface programming.

5.2.2 Characters Available for String Values

Unless noted otherwise in "Value Range", only ASCII characters can be used for parameter values. Unicode characters can also be used in some parameter values.

Available ASCII characters are shown on a white background in the following table:

	00	01	02	03	04	05	06	07	08	09	0A	0B	0C	0D	0E	0F
20	SP	!	"	#	\$	%	&	'	()	*	+	,	-	.	/
30	0	1	2	3	4	5	6	7	8	9	:	;	<	=	>	?
40	@	A	B	C	D	E	F	G	H	I	J	K	L	M	N	O
50	P	Q	R	S	T	U	V	W	X	Y	Z	[\]	^	_
60	`	a	b	c	d	e	f	g	h	i	j	k	l	m	n	o
70	p	q	r	s	t	u	v	w	x	y	z	{		}	~	

5.3 System Settings

5.3.1 System Settings

FACTORY_RESET_ENABLE

Value Format	BOOLEAN
Description	Specifies whether to enable or disable the operation of factory default and carrier default.
Value Range	<ul style="list-style-type: none"> • \mathcal{Y}: Enable factory reset operation • \mathcal{N}: Disable
Default Value	\mathcal{Y}

BUTTON_LOCATION_SETTING

Value Format	INTEGER
Description	Specifies the order (normal or reverse) of flexible keys and DSS keys.
Value Range	<ul style="list-style-type: none"> • 0: Normal • 1: Reverse
Default Value	0

SYS_HOME_MENU_ICONx

Value Format	INTEGER
Description	x=1–20 Specifies an arrangement of the icons on the Home menu.
Value Range	0: Original position 1: None 2: Function 3: Phonebook 4: Call History 5: Voice Message 6: FWD/DND 7: Application 8: Basic Settings 9: System Settings 10: Advanced Settings 11: Line Status 12: Presence 13: Call Center/Call Centre 14: Paging 15: Network Camera 16: Comm. Camera 17: XML shortcut1 18: XML shortcut2 19: XML shortcut3 20: XML shortcut4 21: XML shortcut5 22: XML shortcut6

Default Value	0
---------------	---

Location numbers (x=1–20) of the icons on the Home menu



FWD_DND_MENU_ENABLE

Value Format	BOOLEAN
Description	Specifies whether the "FWD/DND" setting is displayed in the menu.
Value Range	<ul style="list-style-type: none"> • Y: Displayed • N: Not displayed
Default Value	Y

BLOCK_ANONY_MENU_ENABLE

Value Format	BOOLEAN
Description	Specifies whether the "Block Anonymous" setting is displayed in the menu.
Value Range	<ul style="list-style-type: none"> • Y: Displayed • N: Not displayed
Default Value	Y

ANONY_CALL_MENU_ENABLE

Value Format	BOOLEAN
Description	Specifies whether the "Anonymous Call" setting is displayed in the menu.
Value Range	<ul style="list-style-type: none"> • Y: Displayed • N: Not displayed
Default Value	Y

TIME_ZONE_SET_ENABLE

Value Format	BOOLEAN
Description	Specifies whether the "Time Zone" setting is displayed in the menu.
Value Range	<ul style="list-style-type: none"> • Y: Displayed • N: Not displayed
Default Value	N

DISPLAY_CALL_KEY_ENABLE

Value Format	BOOLEAN
Description	Specifies whether call information is displayed on Line and BLF program/DSS keys.
Value Range	<ul style="list-style-type: none"> • Y: Displayed • N: Not displayed
Default Value	N

5.3.2 Basic Network Settings

IP_ADDR_MODE

Value Format	INTEGER
Description	Specifies the IP addressing mode.
Value Range	<ul style="list-style-type: none"> • 0: IPv4 • 1: IPv6 • 2: IPv4&IPv6
Default Value	0
Web User Interface Reference	IP Addressing Mode

CONNECTION_TYPE

Value Format	INTEGER
Description	Specifies whether to assign the IP address automatically (DHCP) or manually (static) for IPv4.
Value Range	<ul style="list-style-type: none"> • 0: Static • 1: DHCP
Default Value	1
Web User Interface Reference	Connection Mode

STATIC_IP_ADDRESS

Value Format	IPADDR
---------------------	--------

Description	Specifies the IP address for the unit for IPv4. Note <ul style="list-style-type: none"> • This setting is available only when "CONNECTION_TYPE" is set to "0". • When you specify this parameter, you must specify "STATIC_SUBNET" together in a configuration file.
Value Range	Max. 15 characters n.n.n.n [n=0–255]
Default Value	Empty string
Web User Interface Reference	IP Address

STATIC_SUBNET

Value Format	IPADDR
Description	Specifies the subnet mask for IPv4. Note <ul style="list-style-type: none"> • This setting is available only when "CONNECTION_TYPE" is set to "0". • When you specify this parameter, you must specify "STATIC_IP_ADDRESS" together in a configuration file.
Value Range	Max. 15 characters n.n.n.n [n=0–255]
Default Value	Empty string
Web User Interface Reference	Subnet Mask

STATIC_GATEWAY

Value Format	IPADDR
Description	Specifies the IP address of the default gateway for the IPv4 network where the unit is connected. Note <ul style="list-style-type: none"> • This setting is available only when "CONNECTION_TYPE" is set to "0". • When you specify this parameter, you must specify "STATIC_IP_ADDRESS" and "STATIC_SUBNET" together in a configuration file.
Value Range	Max. 15 characters n.n.n.n [n=0–255]
Default Value	Empty string
Web User Interface Reference	Default Gateway

USER_DNS1_ADDR

Value Format	IPADDR
---------------------	--------

5.3.2 Basic Network Settings

Description	Specifies the IP address of the primary DNS server for IPv4. Note <ul style="list-style-type: none">This setting is available only when "CONNECTION_TYPE" is set to "0".
Value Range	Max. 15 characters n.n.n.n [n=0–255]
Default Value	Empty string
Web User Interface Reference	DNS1

USER_DNS2_ADDR

Value Format	IPADDR
Description	Specifies the IP address of the secondary DNS server for IPv4. Note <ul style="list-style-type: none">This setting is available only when "CONNECTION_TYPE" is set to "0".
Value Range	Max. 15 characters n.n.n.n [n=0–255]
Default Value	Empty string
Web User Interface Reference	DNS2

DHCP_DNS_ENABLE

Value Format	BOOLEAN
Description	Specifies whether to enable or disable using the DNS server obtained by DHCPv4. Note <ul style="list-style-type: none">This setting is available only when "CONNECTION_TYPE" is set to "1".
Value Range	<ul style="list-style-type: none">ⓧ: Not use (use static DNS)Ⓝ: Use DNS obtained by DHCPv4
Default Value	Ⓝ
Web User Interface Reference	Auto DNS via DHCP

DHCP_HOST_NAME

Value Format	STRING
Description	Specifies the host name to option12 in DHCPv4 or option15 in DHCPv6.

Value Range	Max. 64 characters Note <ul style="list-style-type: none">If "{MODEL}" is included in this parameter, it will be replaced with the unit's model name.
Default Value	{MODEL}
Web User Interface Reference	DHCP Host Name

DHCP_VENDOR_CLASS

Value Format	STRING
Description	Specifies the vendor class to option60 in DHCPv4 or option16 in DHCPv6.
Value Range	Max. 64 characters
Default Value	Panasonic

CONNECTION_TYPE_IPV6

Value Format	INTEGER
Description	Specifies the IP address setting mode for IPv6.
Value Range	<ul style="list-style-type: none"> 0: Static 1: DHCP 2: Stateless Autoconfiguration
Default Value	1
Web User Interface Reference	Connection Mode

STATIC_IP_ADDRESS_IPV6

Value Format	IPADDR-V6
Description	Specifies the IP address for IPv6.
Value Range	Max. 39 characters n:n:n:n:n:n:n [n=0-FFFF, abbreviation available]
Default Value	Empty string
Web User Interface Reference	IP Address

PREFIX_IPV6

Value Format	INTEGER
Description	Specifies the prefix for IPv6.
Value Range	0–128
Default Value	64
Web User Interface Reference	Prefix

STATIC_GATEWAY_IPV6

Value Format	IPADDR-V6
Description	Specifies the default gateway for IPv6.
Value Range	Max. 39 characters n:n:n:n:n:n:n [n=0-FFFF, abbreviation available]
Default Value	Empty string
Web User Interface Reference	Default Gateway

USER_DNS1_ADDR_IPV6

Value Format	IPADDR-V6
Description	Specifies the IP address of primary DNS server for IPv6.
Value Range	Max. 39 characters n:n:n:n:n:n:n [n=0-FFFF, abbreviation available]
Default Value	Empty string
Web User Interface Reference	DNS1

USER_DNS2_ADDR_IPV6

Value Format	IPADDR-V6
Description	Specifies the IP address of secondary DNS server for IPv6.
Value Range	Max. 39 characters n:n:n:n:n:n:n [n=0-FFFF, abbreviation available]
Default Value	Empty string
Web User Interface Reference	DNS2

DHCP_DNS_ENABLE_IPV6

Value Format	BOOLEAN
Description	Specifies whether to enable or disable using the DNS server obtained by DHCPv6.
Value Range	<ul style="list-style-type: none"> • Y: Not use (use static DNS) • N: Use DNS obtained by DHCPv6
Default Value	N
Web User Interface Reference	Auto DNS via DHCP

5.3.3 Ethernet Port Settings**PHY_MODE_LAN**

Value Format	INTEGER
Description	Specifies the link speed and duplex mode of the LAN port.

Value Range	<ul style="list-style-type: none"> • 1: Auto • 2: 100Mbps/Full Duplex • 3: 100Mbps/Half Duplex • 4: 10Mbps/Full Duplex • 5: 10Mbps/Half Duplex
Default Value	1
Web User Interface Reference	LAN Port

PHY_MODE_PC

Value Format	INTEGER
Description	Specifies the link speed and duplex mode of the PC port.
Value Range	<ul style="list-style-type: none"> • 1: Auto • 2: 100Mbps/Full Duplex • 3: 100Mbps/Half Duplex • 4: 10Mbps/Full Duplex • 5: 10Mbps/Half Duplex
Default Value	1
Web User Interface Reference	PC Port

VLAN_ENABLE

Value Format	BOOLEAN
Description	<p>Specifies whether to use the VLAN feature to perform VoIP communication securely.</p> <p>Note</p> <ul style="list-style-type: none"> • You should specify "Y" for only one of "LLDP_ENABLE" or "VLAN_ENABLE". <p>If "Y" is specified for two or more of the parameters above, the settings are prioritized as follows: "VLAN_ENABLE" > "LLDP_ENABLE". Therefore, if "Y" is specified for both "VLAN_ENABLE" and "LLDP_ENABLE", the VLAN-related settings are used.</p>
Value Range	<ul style="list-style-type: none"> • Y (Enable) • N (Disable)
Default Value	N
Web User Interface Reference	Enable VLAN

VLAN_ID_IP_PHONE

Value Format	INTEGER
Description	Specifies the VLAN ID for this unit.
Value Range	0–4094

5.3.3 Ethernet Port Settings

Default Value	2
Web User Interface Reference	IP Phone VLAN ID

VLAN_PRI_IP_PHONE

Value Format	INTEGER
Description	Specifies the priority number for the unit.
Value Range	0–7
Default Value	7
Web User Interface Reference	IP Phone Priority

VLAN_ID_PC

Value Format	INTEGER
Description	Specifies the VLAN ID for the PC.
Value Range	0–4094
Default Value	1
Web User Interface Reference	PC VLAN ID

VLAN_PRI_PC

Value Format	INTEGER
Description	Specifies the priority number for the PC.
Value Range	0–7
Default Value	0
Web User Interface Reference	PC Priority

LLDP_ENABLE

Value Format	BOOLEAN
Description	<p>Specifies whether to enable or disable the LLDP-MED feature.</p> <p>Note</p> <ul style="list-style-type: none">You should specify "Y" for only one of "LLDP_ENABLE", or "VLAN_ENABLE". If "Y" is specified for two or more of the parameters above, the settings are prioritized as follows: VLAN_ENABLE > LLDP_ENABLE. Therefore, if "Y" is specified for both "VLAN_ENABLE" and "LLDP_ENABLE", the VLAN-related settings are used.
Value Range	<ul style="list-style-type: none">Y: Enable LLDP-MEDN: Disable
Default Value	Y
Web User Interface Reference	Enable LLDP

LLDP_INTERVAL

Value Format	INTEGER
Description	Specifies the interval, in seconds, between sending each LLDP frame.
Value Range	1–3600
Default Value	30
Web User Interface Reference	Packet Interval

LLDP_VLAN_ID_PC

Value Format	INTEGER
Description	Specifies the VLAN ID for the PC when LLDP is on.
Value Range	0–4094
Default Value	0
Web User Interface Reference	PC VLAN ID

LLDP_VLAN_PRI_PC

Value Format	INTEGER
Description	Specifies the VLAN Priority for the PC when LLDP is on.
Value Range	0–7
Default Value	0
Web User Interface Reference	PC Priority

5.3.4 Pre-Provisioning Settings

SIPPNP_PROV_ENABLE

Value Format	BOOLEAN
Description	Specifies whether to enable or disable the SIP PnP provisioning.
Value Range	<ul style="list-style-type: none"> • Y: Enable SIP PnP provisioning • N: Disable
Default Value	Y

OPTION66_ENABLE

Value Format	BOOLEAN
Description	<p>Specifies whether to enable or disable the DHCP option 66 provisioning.</p> <p>Note</p> <ul style="list-style-type: none"> • The unit will try to download configuration files through the TFTP server, the IP address or FQDN of which is specified in the option number 66 field.

5.3.5 Provisioning Settings

Value Range	<ul style="list-style-type: none">• Y: Enable DHCP option66 provisioning• N: Disable
Default Value	Y

OPTION159_PROV_ENABLE

Value Format	BOOLEAN
Description	Specifies whether to enable or disable the DHCP option159 provisioning.
Value Range	<ul style="list-style-type: none">• Y: Enable DHCP option159 provisioning• N: Disable
Default Value	Y

OPTION160_PROV_ENABLE

Value Format	BOOLEAN
Description	Specifies whether to enable or disable the DHCP option160 provisioning.
Value Range	<ul style="list-style-type: none">• Y: Enable DHCP option160 provisioning• N: Disable
Default Value	Y

DHCPV6_OPTION17_PROV_ENABLE

Value Format	BOOLEAN
Description	Specifies whether to enable or disable DHCPv6 option17 provisioning.
Value Range	<ul style="list-style-type: none">• Y: Enable DHCPv6 option17 provisioning• N: Disable
Default Value	Y

5.3.5 Provisioning Settings

CFG_STANDARD_FILE_PATH

Value Format	STRING
Description	Specifies the URL of the standard configuration file, which is used when every unit needs different settings.

Value Range	Max. 384 characters Note <ul style="list-style-type: none"> If this URL ends with "/" (slash), "<code>Config{mac}.cfg</code>" is automatically added at the end of the URL. For example, <code>CFG_STANDARD_FILE_PATH="http:// host/dir/"</code> becomes <code>CFG_STANDARD_FILE_PATH="http://host/dir/Config{mac}.cfg"</code>. For details about the formats, see 2.1.3 Server Address Formats.
Default Value	Empty string
Web User Interface Reference	Standard File URL

CFG_PRODUCT_FILE_PATH

Value Format	STRING
Description	Specifies the URL of the product configuration file, which is used when all units with the same model number need the same settings.
Value Range	Max. 384 characters Note <ul style="list-style-type: none"> If this URL ends with "/" (slash), "<code>{MODEL}.cfg</code>" is automatically added at the end of the URL. For example, <code>CFG_PRODUCT_FILE_PATH="http://host/ dir/"</code> becomes <code>CFG_PRODUCT_FILE_PATH="http:// host/dir/{MODEL}.cfg"</code>. For details about the formats, see 2.1.3 Server Address Formats.
Default Value	Empty string
Web User Interface Reference	Product File URL

CFG_MASTER_FILE_PATH

Value Format	STRING
Description	Specifies the URL of the master configuration file, which is used when all units need the same settings.
Value Range	Max. 384 characters Note <ul style="list-style-type: none"> If this URL ends with "/" (slash), "<code>sip.cfg</code>" is automatically added at the end of the URL. For example, <code>CFG_MASTER_FILE_PATH="http://host/ dir/"</code> becomes <code>CFG_MASTER_FILE_PATH="http:// host/dir/sip.cfg"</code>. For details about the formats, see 2.1.3 Server Address Formats.
Default Value	Empty string
Web User Interface Reference	Master File URL

CFG_CYCLIC

Value Format	BOOLEAN
Description	Specifies whether the unit periodically checks for updates of configuration files.
Value Range	<ul style="list-style-type: none"> • Y: Enable periodic synchronization • N: Disable
Default Value	N
Web User Interface Reference	Cyclic Auto Resync

CFG_CYCLIC_INTVL

Value Format	INTEGER
Description	Specifies the interval, in minutes, between periodic checks for updates of the configuration files.
Value Range	1–40320
Default Value	10080
Web User Interface Reference	Resync Interval

CFG_RESYNC_TIME

Value Format	STRING
Description	Specifies the time (hour:minute) that the unit checks for updates of configuration files.
Value Range	00:00–23:59 Note <ul style="list-style-type: none"> • If the value for this setting is any valid value other than an empty string, the unit downloads the configuration files at the fixed time, and the settings specified in "CFG_CYCLIC", "CFG_CYCLIC_INTVL", and "CFG_RTRY_INTVL" are disabled. • If the value for this setting is an empty string, downloading the configuration files at the fixed time are disabled.
Default Value	Empty string
Web User Interface Reference	Time Resync

CFG_RTRY_INTVL

Value Format	INTEGER
Description	Specifies the period of time, in minutes, that the unit will retry checking for an update of the configuration files after a configuration file access error has occurred. Note <ul style="list-style-type: none"> • This setting is available only when "CFG_CYCLIC" is set to "Y".
Value Range	1–1440

Default Value	30
---------------	----

CFG_RESYNC_FROM_SIP

Value Format	STRING
Description	Specifies the value of the "Event" header sent from the SIP server to the unit so that the unit can access the configuration files on the provisioning server.
Value Range	Max. 15 characters
Default Value	check-sync
Web User Interface Reference	Header Value for Resync Event

CFG_RESYNC_ACTION

Value Format	INTEGER
Description	Specifies the value of the action after received resync NOTIFY.
Value Range	<ul style="list-style-type: none"> • 0: Provisioning • 1: TR-069 Inform • 2: Reboot
Default Value	0

CFG_FILE_KEY2

Value Format	STRING
Description	<p>Specifies the encryption key (password) used to decrypt configuration files.</p> <p>Note</p> <ul style="list-style-type: none"> • If the extension of the configuration file is ".e2c", the configuration file will be decrypted using this key.
Value Range	<p>32 characters</p> <p>Note</p> <ul style="list-style-type: none"> • If an empty string is set for this parameter, decryption with this value is disabled.
Default Value	Empty string

CFG_FILE_KEY3

Value Format	STRING
Description	<p>Specifies the encryption key (password) used to decrypt configuration files.</p> <p>Note</p> <ul style="list-style-type: none"> • If the extension of the configuration file is ".e3c", the configuration file will be decrypted using this key.

5.3.5 Provisioning Settings

Value Range	32 characters Note <ul style="list-style-type: none">If an empty string is set for this parameter, decryption with this value is disabled.
Default Value	Empty string

CFG_FILE_KEY_LENGTH

Value Format	INTEGER
Description	Specifies the key lengths in bits used to decrypt configuration files.
Value Range	128,192,256
Default Value	192

CFG_ROOT_CERTIFICATE_PATH

Value Format	STRING
Description	Specifies the URI where the root certificate is stored. Note <ul style="list-style-type: none">Changing this setting may require restarting the unit.
Value Range	Max. 384 characters Note <ul style="list-style-type: none">For details about the formats, see 2.1.3 Server Address Formats.
Default Value	Empty string

CFG_CLIENT_CERT_PATH

Value Format	STRING
Description	Specifies the URI where the client certificate is stored.
Value Range	Max. 384 characters Note <ul style="list-style-type: none">For details about the formats, see 2.1.3 Server Address Formats.
Default Value	Empty string

CFG_PKEY_PATH

Value Format	STRING
Description	Specifies the URI where the private key is stored.

Value Range	Max. 384 characters Note <ul style="list-style-type: none"> For details about the formats, see 2.1.3 Server Address Formats.
Default Value	Empty string

HTTP_SSL_VERIFY

Value Format	INTEGER
Description	Specifies whether to enable the verification of the root certificate.
Value Range	<ul style="list-style-type: none"> 0 (No verification of root certificate) 1 (Simple verification of root certificate) 2 (Precise verification of root certificate) Note <ul style="list-style-type: none"> If set to "0", the verification of the root certificate is disabled. If set to "1", the verification of the root certificate is enabled. In this case, the validity of the certificate's date, certificate's chain, and the confirmation of the root certificate will be verified. If set to "2", precise certificate verification is enabled. In this case, the validity of the server name will be verified in addition to the items verified when "1" is set. If the unit has not obtained the current time, verification will not be performed irrelevant of this setting. In order to perform verification it is necessary to first set up the NTP server.
Default Value	0

CFG_RESYNC_DURATION

Value Format	INTEGER
Description	Specifies, in minutes, a time range during which connected units can access the server. Units will download configuration files at a random time within this range.
Value Range	0–1439
Default Value	0

5.3.6 Firmware Update Settings

FIRM_UPGRADE_ENABLE

Value Format	BOOLEAN
---------------------	---------

5.3.6 Firmware Update Settings

Description	Specifies whether to perform firmware updates when the unit detects a newer version of firmware. Note <ul style="list-style-type: none">Firmware updates using TR-069 can be performed regardless of this setting.
Value Range	<ul style="list-style-type: none">Y (Enable firmware updates)N (Disable firmware updates)
Default Value	Y
Web User Interface Reference	Enable Firmware Update

FIRM_FILE_PATH

Value Format	STRING
Description	Specifies the URL where the firmware file is stored. Note <ul style="list-style-type: none">This setting is available only when "FIRM_UPGRADE_ENABLE" is set to "Y".
Value Range	Max. 384 characters Note <ul style="list-style-type: none">If "{fwver}" is included in this parameter, it will be replaced with the value specified in "FIRM_VERSION". For details about the formats, see 2.1.3 Server Address Formats.
Default Value	Empty string
Web User Interface Reference	Firmware File URL

FIRM_VERSION

Value Format	STRING
Description	Specifies the firmware version of the unit.
Value Range	Max. 32 characters
Default Value	Empty string
Web User Interface Reference	Firmware Version

FWDL_RANDOM_DURATION

Value Format	INTEGER
Description	Specifies, in minutes, a time range during which connected units can access the server. Units will download the firmware file at a random time within this range.
Value Range	0–1439
Default Value	0

5.3.7 HTTP Settings

HTTP_VER

Value Format	INTEGER
Description	Specifies which version of the HTTP protocol to use for HTTP communication.
Value Range	<ul style="list-style-type: none"> • 1 (Use HTTP 1.0) • 0 (Use HTTP 1.1) <p>Note</p> <ul style="list-style-type: none"> • For this unit, it is strongly recommended that you specify "1" for this setting. However, if the HTTP server does not function well with HTTP 1.0, try changing the setting "0".
Default Value	1
Web User Interface Reference	HTTP Version

HTTP_USER_AGENT

Value Format	STRING
Description	Specifies the text string to send as the user agent in the header of HTTP requests.
Value Range	<p>Max. 64 characters</p> <p>Note</p> <ul style="list-style-type: none"> • If "{mac}" is included in this parameter, it will be replaced with the unit's MAC address in lower-case. • If "{MAC}" is included in this parameter, it will be replaced with the unit's MAC address in upper-case. • If "{MODEL}" is included in this parameter, it will be replaced with the unit's model name. • If "{fwver}" is included in this parameter, it will be replaced with the firmware version of the unit.
Default Value	Panasonic_{MODEL}/{fwver} ({mac})
Web User Interface Reference	HTTP User Agent

HTTP_AUTH_ID

Value Format	STRING
Description	Specifies the authentication ID required to access the HTTP server.
Value Range	Max. 128 characters
Default Value	Empty string
Web User Interface Reference	Authentication ID

HTTP_AUTH_PASS

Value Format	STRING
Description	Specifies the authentication password required to access the HTTP server.
Value Range	Max. 128 characters
Default Value	Empty string
Web User Interface Reference	Authentication Password

HTTP_PROXY_ENABLE

Value Format	BOOLEAN
Description	Specifies whether to enable or disable the HTTP proxy feature.
Value Range	<ul style="list-style-type: none"> • Y: Enable HTTP proxy connect • N: Disable
Default Value	N
Web User Interface Reference	Enable Proxy

HTTP_PROXY_ADDR

Value Format	STRING
Description	Specifies the IP address or FQDN of the proxy server.
Value Range	Max. 256 characters
Default Value	Empty string
Web User Interface Reference	Proxy Server Address

HTTP_PROXY_PORT

Value Format	INTEGER
Description	Specifies the port of the proxy server.
Value Range	1–65535
Default Value	8080
Web User Interface Reference	Proxy Server Port

HTTP_PROXY_ID

Value Format	STRING
Description	Specifies the user ID for connecting HTTP proxy.
Value Range	Max. 128 characters
Default Value	Empty string

HTTP_PROXY_PASS

Value Format	STRING
Description	Specifies the password for connecting HTTP proxy.

Value Range	Max. 128 characters
Default Value	Empty string

5.3.8 HTTPD/WEB Settings

HTTPD_LISTEN_PORT

Value Format	INTEGER
Description	Specifies the port number of own HTTP server.
Value Range	80, 1024–49151
Default Value	80

HTTPD_PORTOPEN_AUTO

Value Format	BOOLEAN
Description	Specifies whether the unit's Web port is always open.
Value Range	<ul style="list-style-type: none"> • Y (Web port is always open) • N (Web port is closed [can be opened temporarily through phone user interface programming]) <p>Notice</p> <ul style="list-style-type: none"> • If you want to set to "Y", please fully recognize the possibility of unauthorized access to the unit through the Web user interface and change this setting at your own risk. In addition, please take full security measures for connecting to an external network and control all passwords for logging in to the Web user interface.
Default Value	N

HTTPD_PORTCLOSE_TM

Value Format	INTEGER
Description	Specifies port close time when keeping the no action.
Value Range	1–1440
Default Value	30

USER_ID

Value Format	STRING
Description	Specifies the account ID used to access the Web user interface with the User account.

Value Range	Max. 16 characters (except !, ", #, \$, %, &, ', (,), @, *, +, ,, /, :, ;, <, =, >, ?, [,], ^, `, {, , }, ~, \ and space) Note <ul style="list-style-type: none"> • An empty string is not allowed. • A hyphen (-) cannot be used as the first character.
Default Value	user

USER_PASS

Value Format	STRING
Description	Specifies the password to use to authenticate the User account when logging in to the Web user interface.
Value Range	6–64 characters (except !, ", #, \$, %, &, ', (,), @, *, +, ,, /, :, ;, <, =, >, ?, [,], ^, `, {, , }, ~, \ and space) Note <ul style="list-style-type: none"> • A hyphen (-) cannot be used as the first character.
Default Value	Empty string (only before a user accesses the Web user interface for the first time)
Web User Interface Reference	New Password

ADMIN_ID

Value Format	STRING
Description	Specifies the account ID used to access the Web user interface with the Admin account.
Value Range	Max. 16 characters (except !, ", #, \$, %, &, ', (,), @, *, +, ,, /, :, ;, <, =, >, ?, [,], ^, `, {, , }, ~, \ and space) Note <ul style="list-style-type: none"> • An empty string is not allowed. • A hyphen (-) cannot be used as the first character.
Default Value	admin

ADMIN_PASS

Value Format	STRING
Description	Specifies the password to use to authenticate the Administrator account when logging in to the Web user interface.

Value Range	6–64 characters (except !, ", #, \$, %, &, ', (,), @, *, +, ,, /, :, ;, <, =, >, ?, [,], ^, ` , {, , }, ~, \ and space) Note <ul style="list-style-type: none">A hyphen (-) cannot be used as the first character.
Default Value	adminpass
Web User Interface Reference	New Password

5.3.9 TR-069 Settings

ACS_URL

Value Format	STRING
Description	Specifies the URL of the Auto-Configuration Server for using TR-069. Note <ul style="list-style-type: none">This parameter must be in the form of a valid HTTP or HTTPS URL, as defined in RFC 3986.
Value Range	Max. 256 characters
Default Value	Empty string

ACS_USER_ID

Value Format	STRING
Description	Specifies the user ID for the Auto-Configuration Server for using TR-069.
Value Range	Max. 256 characters (except ", &, ', :, <, >, and space)
Default Value	Empty string

ACS_PASS

Value Format	STRING
Description	Specifies the user password for the Auto-Configuration Server for using TR-069.
Value Range	Max. 256 characters (except ", &, ', :, <, >, and space)
Default Value	Empty string

PERIODIC_INFORM_ENABLE

Value Format	BOOLEAN
Description	Specifies whether or not the CPE (Customer Premises Equipment) must periodically send CPE information to the ACS (Auto-Configuration Server) using the Inform method call.
Value Range	<ul style="list-style-type: none"> Y (Enable) N (Disable)

Default Value	N
---------------	---

PERIODIC_INFORM_INTERVAL

Value Format	INTEGER
Description	<p>Specifies the interval length, in seconds, when the CPE must attempt to connect with the ACS and call the Inform method.</p> <p>Note</p> <ul style="list-style-type: none"> This setting is available only when "PERIODIC_INFORM_ENABLE" is set to "Y".
Value Range	30–2419200
Default Value	86400

PERIODIC_INFORM_TIME

Value Format	STRING
Description	<p>Specifies the time (UTC) to determine when the CPE will initiate the periodic Inform method calls.</p> <p>Note</p> <ul style="list-style-type: none"> Each Inform call must occur at this reference time plus or minus an integer multiple of the "PERIODIC_INFORM_INTERVAL". This "PERIODIC_INFORM_TIME" parameter is used only to set the "phase" of the periodic Informs. The actual value can be arbitrarily set far into the past or future. For example, if "PERIODIC_INFORM_INTERVAL" is set to 86400 (one day) and if "PERIODIC_INFORM_TIME" is set to midnight on a certain day, then periodic Informs will occur every day at midnight, starting from the set date. If the time is set to "unknown time", the start time depends on the CPE's settings. However, the "PERIODIC_INFORM_INTERVAL" must still be adhered to. If absolute time is not available to the CPE, its periodic Inform behavior must be the same as if the "PERIODIC_INFORM_TIME" parameter was set to the "unknown time". Time zones other than UTC are not supported.
Value Range	4–32 characters date and time format
Default Value	0001-01-01T00:00:00Z

CON_REQ_USER_ID

Value Format	STRING
Description	Specifies the user name used to authenticate an ACS making a Connection Request to the CPE.
Value Range	Max. 256 characters

Default Value	Empty string
---------------	--------------

CON_REQ_PASS

Value Format	STRING
Description	<p>Specifies the password used to authenticate an ACS making a Connection Request to the CPE.</p> <p>Note</p> <ul style="list-style-type: none"> When the "CON_REQ_USER_ID" parameter is specified, an empty string for this parameter is not allowed.
Value Range	Max. 256 characters
Default Value	Empty string

ANNEX_G_STUN_ENABLE

Value Format	BOOLEAN
Description	<p>Specifies whether or not the CPE can use STUN. This applies only to the use of STUN in association with the ACS to allow UDP Connection Requests.</p>
Value Range	<ul style="list-style-type: none"> Y (Enable) N (Disable)
Default Value	N

ANNEX_G_STUN_SERV_ADDR

Value Format	STRING
Description	<p>Specifies the host name or IP address of the STUN server for the CPE to send Binding Requests.</p> <p>Note</p> <ul style="list-style-type: none"> This setting is available only when "ANNEX_G_STUN_ENABLE" is set to "Y". If the value for this setting is an empty string and "ANNEX_G_STUN_ENABLE" is set to "Y", the CPE must use the address of the ACS extracted from the host portion of the ACS URL.
Value Range	Max. 256 characters
Default Value	Empty string

ANNEX_G_STUN_SERV_PORT

Value Format	INTEGER
--------------	---------

Description	Specifies the port number of the STUN server for the CPE to send Binding Requests. Note <ul style="list-style-type: none"> This setting is available only when "ANNEX_G_STUN_ENABLE" is set to "Y".
Value Range	1–65535
Default Value	3478

ANNEX_G_STUN_USER_ID

Value Format	STRING
Description	Specifies the STUN user name to be used in Binding Requests (only if message integrity has been requested by the STUN server). Note <ul style="list-style-type: none"> If the value for this setting is an empty string, the CPE must not send STUN Binding Requests with message integrity.
Value Range	Max. 256 characters (except ", &, ', :, <, >, and space)
Default Value	Empty string

ANNEX_G_STUN_PASS

Value Format	STRING
Description	Specifies the STUN password to be used in computing the MESSAGE-INTEGRITY attribute used in Binding Requests (only if message integrity has been requested by the STUN server). When read, this parameter returns an empty string, regardless of the actual value.
Value Range	Max. 256 characters (except ", &, ', :, <, >, and space)
Default Value	Empty string

ANNEX_G_STUN_MAX_KEEP_ALIVE

Value Format	INTEGER
Description	Specifies the maximum period, in seconds, that STUN Binding Requests must be sent by the CPE for the purpose of maintaining the binding in the Gateway. This applies specifically to Binding Requests sent from the UDP Connection Request address and port. Note <ul style="list-style-type: none"> This setting is available only when "ANNEX_G_STUN_ENABLE" is set to "Y".
Value Range	1–3600
Default Value	300

ANNEX_G_STUN_MIN_KEEP_ALIVE

Value Format	INTEGER
Description	Specifies the minimum period, in seconds, that STUN Binding Requests can be sent by the CPE for the purpose of maintaining the binding in the Gateway. This limit applies only to Binding Requests sent from the UDP Connection Request address and port, and only those that do not contain the BINDING-CHANGE attribute. Note <ul style="list-style-type: none"> This setting is available only when "ANNEX_G_STUN_ENABLE" is set to "Y".
Value Range	1–3600
Default Value	30

UDP_CON_REQ_ADDR_NOTIFY_LIMIT

Value Format	INTEGER
Description	Specifies the minimum time, in seconds, between Active Notifications resulting from changes to the "UDPConnectionRequestAddress" (if Active Notification is enabled).
Value Range	0–65535
Default Value	0

DEVICE_PROVISIONING_CODE

Value Format	STRING
Description	Specifies the device provisioning code for use with TR-106 parameters.
Value Range	Max. 64 characters
Default Value	Empty string

5.3.10 XML Settings

XMLAPP_ENABLE

Value Format	BOOLEAN
Description	Specifies whether to enable the XML application feature.
Value Range	<ul style="list-style-type: none"> Y: Enable XML application N: Disable
Default Value	N
Web User Interface Reference	Enable XMLAPP

XMLAPP_USERID

Value Format	STRING
---------------------	--------

5.3.10 XML Settings

Description	Specifies the authentication ID required to access the XML application server.
Value Range	Max. 128 characters
Default Value	Empty string
Web User Interface Reference	User ID

XMLAPP_USERPASS

Value Format	STRING
Description	Specifies the authentication password used to access the XML application server.
Value Range	Max. 128 characters
Default Value	Empty string
Web User Interface Reference	Password

XMLAPP_LDAP_URL

Value Format	STRING
Description	Specifies the URL that is accessed when the phonebook is accessed, to check for XML data.
Value Range	Max. 256 characters
Default Value	Empty string
Web User Interface Reference	LDAP URL

XMLAPP_LDAP_USERID

Value Format	STRING
Description	Specifies the authentication ID required to access the LDAP server.
Value Range	Max. 128 characters
Default Value	Empty string
Web User Interface Reference	User ID

XMLAPP_LDAP_USERPASS

Value Format	STRING
Description	Specifies the authentication password used to access the LDAP server.
Value Range	Max. 128 characters
Default Value	Empty string
Web User Interface Reference	Password

XMLAPP_NPB_SEARCH_TIMER

Value Format	INTEGER
Description	Specifies the time which is for searching XML phonebook.

Value Range	1–65535
Default Value	30

XMLAPP_LDAP_MAXRECORD

Value Format	INTEGER
Description	Specifies the maximum number of search results to be returned by the LDAP server.
Value Range	20–500
Default Value	20
Web User Interface Reference	Max Hits

XML_HTTPD_PORT

Value Format	INTEGER
Description	Specifies the local HTTP port for XML application.
Value Range	1–65535
Default Value	6666
Web User Interface Reference	Local XML Port

XML_ERROR_INFORMATION

Value Format	BOOLEAN
Description	Specifies whether to display an error information when an error occurs.
Value Range	<ul style="list-style-type: none"> • Y: Error information is displayed • N: Error information is not displayed
Default Value	Y

XMLAPP_START_URL

Value Format	STRING
Description	Specifies the URL that is accessed when the unit starts up, to check for XML data.
Value Range	Max. 256 characters
Default Value	Empty string
Web User Interface Reference	Bootup URL

XMLAPP_INITIAL_URL

Value Format	STRING
Description	Specifies the URL that is accessed when the application is started from the unit's menu, to check for XML data.
Value Range	Max. 256 characters
Default Value	Empty string

Web User Interface Reference	Initial URL
-------------------------------------	-------------

XMLAPP_INCOMING_URL

Value Format	STRING
Description	Specifies the URL that is accessed when the unit receives a call, to check for XML data.
Value Range	Max. 256 characters
Default Value	Empty string
Web User Interface Reference	Incoming Call URL

XMLAPP_TALKING_URL

Value Format	STRING
Description	Specifies the URL that is accessed when the unit is on a call, to check for XML data.
Value Range	Max. 256 characters
Default Value	Empty string
Web User Interface Reference	Talking URL

XMLAPP_MAKECALL_URL

Value Format	STRING
Description	Specifies the URL that is accessed when the unit makes a call, to check for XML data.
Value Range	Max. 256 characters
Default Value	Empty string
Web User Interface Reference	Making Call URL

XMLAPP_CALLLOG_URL

Value Format	STRING
Description	Specifies the URL that is accessed when the call log is accessed, to check for XML data.
Value Range	Max. 256 characters
Default Value	Empty string
Web User Interface Reference	Call Log URL

XMLAPP_IDLING_URL

Value Format	STRING
Description	Specifies the URL that is accessed when the unit is idle, to check for XML data.
Value Range	Max. 256 characters
Default Value	Empty string

Web User Interface Reference	Idling URL
-------------------------------------	------------

XMLAPP_FFKEY_ENABLE

Value Format	BOOLEAN
Description	Specifies whether to enable the XML application or operate the telephone normally, when the corresponding button is pressed.
Value Range	<ul style="list-style-type: none"> • Y: XML Mode • N: Normal Telephone Mode
Default Value	N
Web User Interface Reference	Enable FF Key

XMLAPP_STATUSBAR_ENABLE

Value Format	BOOLEAN
Description	Specifies whether to enable or disable the Status Bar XML application feature.
Value Range	<ul style="list-style-type: none"> • Y: Enable the Status Bar XML application feature • N: Disable
Default Value	Y

XMLAPP_URL_FLEX_BUTTONx

Value Format	STRING
Description	x=1–24 Specifies the URL that is accessed when the FFx key is pressed.
Value Range	Max. 256 characters ("&" may also be used)
Default Value	Empty string

SYS_HOME_MENU_XML_NAMEx

Value Format	STRING
Description	x=1–6 Specifies the name of an icon for an XML feature on the Home menu.
Value Range	Max. 24 characters
Default Value	X=1:Application 1 X=2:Application 2 X=3:Application 3 X=4:Application 4 X=5:Application 5 X=6:Application 6

SYS_HOME_MENU_XML_URLx

Value Format	STRING
---------------------	--------

5.3.11 XSI Settings

Description	x=1–6 Specifies the URL that is accessed by an XML feature on the Home menu.
Value Range	Max. 256 characters ("&" may also be used.)
Default Value	Empty string

SYS_HOME_MENU_XML_ICONx

Value Format	INTEGER
Description	x=1–6 Specifies the feature of an icon on the Home menu.
Value Range	1–35
Default Value	13

Icon Type

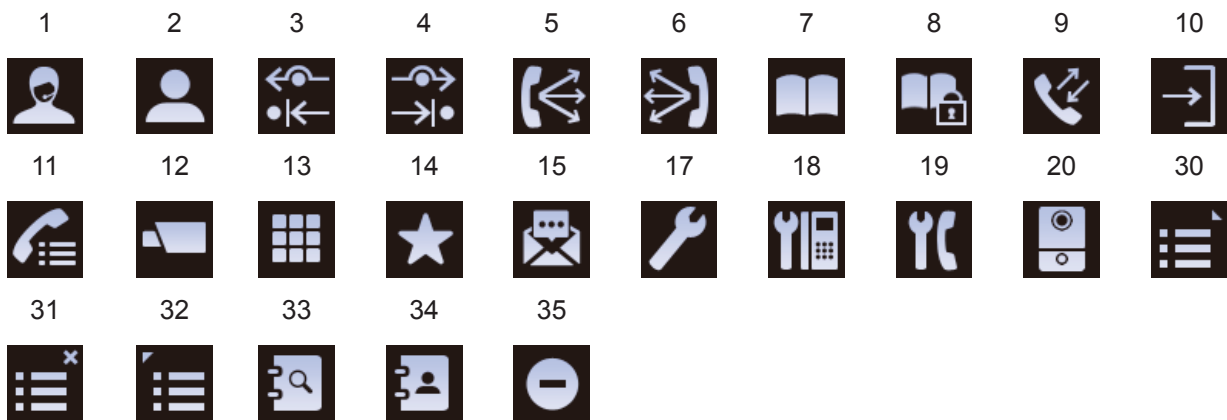

Note

- No.16, 21–29: Blank

5.3.11 XSI Settings

XSI_ENABLE

Value Format	BOOLEAN
Description	Specifies whether to enable or disable the Xsi service.
Value Range	<ul style="list-style-type: none"> • Y: Enable Xsi service • N: Disable
Default Value	N
Web User Interface Reference	Enable Xtended Service

XSI_SERVER

Value Format	STRING
Description	Specifies the IP address or FQDN of the Xsi server.

Value Range	Max. 256 characters
Default Value	Empty string
Web User Interface Reference	Server Address

XSI_SERVER_TYPE

Value Format	STRING
Description	Specifies the type of the Xsi server.
Value Range	<ul style="list-style-type: none"> • HTTP • HTTPS
Default Value	HTTP
Web User Interface Reference	Protocol

XSI_SERVER_PORT

Value Format	INTEGER
Description	Specifies the port of the Xsi server.
Value Range	1–65535
Default Value	80
Web User Interface Reference	Port

XSI_USERID_n

Parameter Name Example	XSI_USERID_1, XSI_USERID_2, ..., XSI_USERID_16
Value Format	STRING
Description	Specifies the authentication ID required to access the Xsi server.
Value Range	Max. 128 characters
Default Value	Empty string
Web User Interface Reference	User ID

XSI_PASSWORD_n

Parameter Name Example	XSI_PASSWORD_1, XSI_PASSWORD_2, ..., XSI_PASSWORD_16
Value Format	STRING
Description	Specifies the authentication password required to access the Xsi server.
Value Range	Max. 128 characters
Default Value	Empty string
Web User Interface Reference	Password

XSI_PHONEBOOK_ENABLE_n

Parameter Name Example	XSI_PHONEBOOK_ENABLE_1, XSI_PHONEBOOK_ENABLE_2, ..., XSI_PHONEBOOK_ENABLE_16
-------------------------------	--

5.3.11 XSI Settings

Value Format	BOOLEAN
Description	Specifies whether to enable or disable the Xsi phonebook service.
Value Range	<ul style="list-style-type: none"> • Y: Enable Xsi phonebook • N: Disable
Default Value	N
Web User Interface Reference	Enable Phonebook

XSI_PHONEBOOK_CYCLIC_INTVL

Value Format	INTEGER
Description	Specifies the interval, in minutes, between periodic checks for updates of the Xsi Directory (Phonebook) files. If this parameter is set to "0", the timing is the same as updating the configuration files.
Value Range	0–40320
Default Value	0

XSI_PHONEBOOK_RESYNC_DURATION

Value Format	INTEGER
Description	Specifies the time range, in minutes, during which connected units can access the server. Xsi Directory (Phonebook) files will be downloaded at a random time within this range.
Value Range	0–1439
Default Value	0

XSI_PHONEBOOK_TYPE_n

Parameter Name Example	XSI_PHONEBOOK_TYPE_1 , XSI_PHONEBOOK_TYPE_2 , ..., XSI_PHONEBOOK_TYPE_16
Value Format	INTEGER
Description	Specifies the type of Xsi phonebook.
Value Range	1: Group 2: GroupCommon 3: Enterprise 4: EnterpriseCommon 5: Personal
Default Value	1
Web User Interface Reference	Phonebook Type

XSI_CALLLOG_ENABLE_n

Parameter Name Example	XSI_CALLLOG_ENABLE_1 , XSI_CALLLOG_ENABLE_2 , ..., XSI_CALLLOG_ENABLE_16
Value Format	BOOLEAN

Description	Specifies whether to enable or disable the Xsi call log service.
Value Range	<ul style="list-style-type: none"> • Y: Enable Xsi call log • N: Disable
Default Value	N
Web User Interface Reference	Enable Call Log

XSI_VISUAL_VM_ENABLE_n

Parameter Name Example	XSI_VISUAL_VM_ENABLE_1, XSI_VISUAL_VM_ENABLE_2, ..., XSI_VISUAL_VM_ENABLE_16
Value Format	BOOLEAN
Description	Specifies whether to enable or disable the Visual Voice Mail feature of the selected line.
Value Range	<ul style="list-style-type: none"> • Y: Enable Visual Voice Mail • N: Disable
Default Value	N
Web User Interface Reference	Enable Visual Voice Mail

XSI_SIP_CREDENTIALS_ENABLE

Value Format	BOOLEAN
Description	Specifies whether to enable or disable the XSI SIP Credentials feature.
Value Range	<ul style="list-style-type: none"> • Y: Enable XSI SIP Credentials • N: Disable
Default Value	N
Web User Interface Reference	SIP Credentials

BSD_MULTI_TYPE_ENABLE

Value Format	BOOLEAN
Description	Specifies whether you can select the type of Xsi phonebook.
Value Range	<ul style="list-style-type: none"> • Y: Enable • N: Disable
Default Value	N

BSD_GROUP_ENABLE_n

Parameter Name Example	BSD_GROUP_ENABLE_1, BSD_GROUP_ENABLE_2, ..., BSD_GROUP_ENABLE_16
Value Format	BOOLEAN
Description	Specifies whether to enable or disable the "Group" type for Xsi phonebooks.

Value Range	<ul style="list-style-type: none"> • Y: Enable • N: Disable
Default Value	N

BSD_GROUPCOM_ENABLE_n

Parameter Name Example	BSD_GROUPCOM_ENABLE_1, BSD_GROUPCOM_ENABLE_2, ..., BSD_GROUPCOM_ENABLE_16
Value Format	BOOLEAN
Description	Specifies whether to enable or disable the "Group Common" type for Xsi phonebooks.
Value Range	<ul style="list-style-type: none"> • Y: Enable • N: Disable
Default Value	N

BSD_ENTERPRISE_ENABLE_n

Parameter Name Example	BSD_ENTERPRISE_ENABLE_1, BSD_ENTERPRISE_ENABLE_2, ..., BSD_ENTERPRISE_ENABLE_16
Value Format	BOOLEAN
Description	Specifies whether to enable or disable the "Enterprise" type for Xsi phonebooks.
Value Range	<ul style="list-style-type: none"> • Y: Enable • N: Disable
Default Value	N

BSD_ENTERPRISECOM_ENABLE_n

Parameter Name Example	BSD_ENTERPRISECOM_ENABLE_1, BSD_ENTERPRISECOM_ENABLE_2, ..., BSD_ENTERPRISECOM_ENABLE_16
Value Format	BOOLEAN
Description	Specifies whether to enable or disable the "Enterprise Common" type for Xsi phonebooks.
Value Range	<ul style="list-style-type: none"> • Y: Enable • N: Disable
Default Value	N

BSD_PERSONAL_ENABLE_n

Parameter Name Example	BSD_PERSONAL_ENABLE_1, BSD_PERSONAL_ENABLE_2, ..., BSD_PERSONAL_ENABLE_16
Value Format	BOOLEAN
Description	Specifies whether to enable or disable the "Personal" type for Xsi phonebooks.

Value Range	<ul style="list-style-type: none"> • Y: Enable • N: Disable
Default Value	N

5.3.12 XMPP (UC-ONE) Settings

UC_ENABLE

Value Format	BOOLEAN
Description	Specifies whether to enable the UC service.
Value Range	<ul style="list-style-type: none"> • Y: Enable UC service • N: Disable
Default Value	N
Web User Interface Reference	Enable UC

UC_USERID

Value Format	STRING
Description	Specifies the authentication ID required to access the UC server.
Value Range	Max. 128 characters
Default Value	Empty string
Web User Interface Reference	User ID

UC_PASSWORD

Value Format	STRING
Description	Specifies the authentication password required to access the UC server.
Value Range	Max. 128 characters
Default Value	Empty string
Web User Interface Reference	Password

XMPP_SERVER

Value Format	STRING
Description	Specifies the IP address or FQDN of the XMPP server.
Value Range	Max. 256 characters
Default Value	Empty string
Web User Interface Reference	Server Address

XMPP_PORT

Value Format	INTEGER
Description	Specifies the local XMPP port.

5.3.12 XMPP (UC-ONE) Settings

Value Range	1–65535
Default Value	5222
Web User Interface Reference	Local XMPP Port

XMPP_TLS_VERIFY

Value Format	INTEGER
Description	Specifies whether to enable the verification of the root certificate.
Value Range	0: No verification 1: Simple verification 2: Precise verification
Default Value	0

XMPP_ROOT_CERT_PATH

Value Format	STRING
Description	Specifies the URI where the root certificate is stored.
Value Range	Max. 384 characters Note <ul style="list-style-type: none">• For details about the formats, see 2.1.3 Server Address Formats.
Default Value	Empty string

XMPP_CLIENT_CERT_PATH

Value Format	STRING
Description	Specifies the URI where the client certificate is stored.
Value Range	Max. 384 characters Note <ul style="list-style-type: none">• For details about the formats, see 2.1.3 Server Address Formats.
Default Value	Empty string

XMPP_PKEY_PATH

Value Format	STRING
Description	Specifies the URI where the private key is stored.
Value Range	Max. 384 characters Note <ul style="list-style-type: none">• For details about the formats, see 2.1.3 Server Address Formats.
Default Value	Empty string

UC_DNSSRV_ENA

Value Format	BOOLEAN
Description	Specifies whether to request the DNS server to translate domain names into IP addresses using the SRV record.
Value Range	<ul style="list-style-type: none"> • Y: Enable DNS SRV lookup • N: Disable
Default Value	N

UC_TCP_SRV_PREFIX

Value Format	STRING
Description	Specifies a prefix to add to the domain name when performing a DNS SRV lookup using TCP.
Value Range	Max. 32 characters
Default Value	_xmpp-client._tcp.

UC_USERID_CASE_SENSITIVE

Value Format	BOOLEAN
Description	Specifies whether the authentication ID is case-sensitive when accessing the UC server.
Value Range	<ul style="list-style-type: none"> • Y: Enable • N: Disable
Default Value	N

5.3.13 LDAP Settings

LDAP_ENABLE

Value Format	BOOLEAN
Description	Specifies whether to enable or disable the LDAP service.
Value Range	<ul style="list-style-type: none"> • Y: Enable LDAP service • N: Disable
Default Value	N
Web User Interface Reference	Enable LDAP

LDAP_DNSSRV_ENABLE

Value Format	BOOLEAN
Description	Specifies whether to request the DNS server to translate domain names into IP addresses using the SRV record.
Value Range	<ul style="list-style-type: none"> • Y: Enable DNS SRV lookup • N: Disable

5.3.13 LDAP Settings

Default Value	N
Web User Interface Reference	Enable DNS SRV lookup

LDAP_SERVER

Value Format	STRING
Description	Specifies the server host of LDAP.
Value Range	Max. 256 characters
Default Value	Empty string
Web User Interface Reference	Server Address

LDAP_SERVER_PORT

Value Format	INTEGER
Description	Specifies the port of the LDAP server.
Value Range	1–65535
Default Value	389
Web User Interface Reference	Port

LDAP_MAXRECORD

Value Format	INTEGER
Description	Specifies the maximum number of search results to be returned by the LDAP server.
Value Range	20–500
Default Value	20
Web User Interface Reference	Max Hits

LDAP_NUMB_SEARCH_TIMER

Value Format	INTEGER
Description	Specifies the timer for searching telephone number.
Value Range	1–65535
Default Value	30

LDAP_NAME_SEARCH_TIMER

Value Format	INTEGER
Description	Specifies the timer for searching name.
Value Range	1–65535
Default Value	5

LDAP_USERID

Value Format	STRING
---------------------	--------

Description	Specifies the authentication ID required to access the LDAP server.
Value Range	Max. 128 characters
Default Value	Empty string
Web User Interface Reference	User ID

LDAP_PASSWORD

Value Format	STRING
Description	Specifies the authentication password required to access the LDAP server.
Value Range	Max. 128 characters
Default Value	Empty string
Web User Interface Reference	Password

LDAP_NAME_FILTER

Value Format	STRING
Description	Specifies the name filter which is the search criteria for name look up.
Value Range	Max. 256 characters
Default Value	((cn=%)(sn=%))
Web User Interface Reference	Name Filter

LDAP_NUMB_FILTER

Value Format	STRING
Description	Specifies the number filter which is the search criteria for number look up.
Value Range	Max. 256 characters
Default Value	((telephoneNumber=%)(mobile=%)(homePhone=%))
Web User Interface Reference	Number Filter

LDAP_NAME_ATTRIBUTE

Value Format	STRING
Description	Specifies the name attributes of each record which are to be returned in the LDAP search result.
Value Range	Max. 256 characters
Default Value	cn,sn
Web User Interface Reference	Name Attributes

LDAP_NUMB_ATTRIBUTE

Value Format	STRING
Description	Specifies the number attributes of each record which are to be returned in the LDAP search result.

5.3.13 LDAP Settings

Value Range	Max. 256 characters
Default Value	telephoneNumber,mobile,homePhone
Web User Interface Reference	Number Attributes

LDAP_BASEDN

Value Format	STRING
Description	Specifies the entry information on the screen.
Value Range	Max. 256 characters
Default Value	Empty string
Web User Interface Reference	Distinguished Name(Base DN)

LDAP_SSL_VERIFY

Value Format	INTEGER
Description	Specifies whether to enable the verification of the root certificate.
Value Range	0: No verification 1: Simple verification 2: Precise verification
Default Value	0

LDAP_ROOT_CERT_PATH

Value Format	STRING
Description	Specifies the URI where the root certificate is stored.
Value Range	Max. 384 characters Note <ul style="list-style-type: none">• For details about the formats, see 2.1.3 Server Address Formats.
Default Value	Empty string

LDAP_CLIENT_CERT_PATH

Value Format	STRING
Description	Specifies the URI where the client certificate is stored.
Value Range	Max. 384 characters Note <ul style="list-style-type: none">• For details about the formats, see 2.1.3 Server Address Formats.
Default Value	Empty string

LDAP_PKEY_PATH

Value Format	STRING
---------------------	--------

Description	Specifies the URI where the private key is stored.
Value Range	Max. 384 characters Note <ul style="list-style-type: none"> For details about the formats, see 2.1.3 Server Address Formats.
Default Value	Empty string

LDAP_DISPLAY_FORMAT

Value Format	STRING
Description	Specifies the display name by using the attributes of each record returned in the LDAP search results.
Value Range	Max. 256 characters (LDAP attributes) A unit uses the initial settings for the display if this setting is NULL.
Default Value	Empty string

5.3.14 Call Center Settings

CALL_CENTER_ENABLE_n

Parameter Name Example	CALL_CENTER_ENABLE_1, CALL_CENTER_ENABLE_2, ..., CALL_CENTER_ENABLE_16
Value Format	BOOLEAN
Description	Specifies whether to add menu items for Call Center.
Value Range	<ul style="list-style-type: none"> Y: Enable N: Disable
Default Value	N
Web User Interface Reference	Enable Call Center

ACD_ENABLE_n

Parameter Name Example	ACD_ENABLE_1, ACD_ENABLE_2, ..., ACD_ENABLE_16
Value Format	BOOLEAN
Description	Specifies whether to enable the ACD.
Value Range	<ul style="list-style-type: none"> Y: Enable N: Disable
Default Value	N
Web User Interface Reference	Enable ACD

ACD_LOGIN_CONDITION_n

Parameter Name Example	ACD_LOGIN_CONDITION_1, ACD_LOGIN_CONDITION_2, ..., ACD_LOGIN_CONDITION_16
Value Format	INTEGER

5.3.14 Call Center Settings

Description	Specifies the ACD state when login to the ACD.
Value Range	<ul style="list-style-type: none"> • 0: Available • 1: Unavailable
Default Value	0

ACD_LOGOUT_CONDITION_n

Parameter Name Example	ACD_LOGOUT_CONDITION_1, ACD_LOGOUT_CONDITION_2, ..., ACD_LOGOUT_CONDITION_16
Value Format	INTEGER
Description	Specifies the ACD state when logout to the ACD.
Value Range	<ul style="list-style-type: none"> • 0: Continue • 1: Unavailable
Default Value	1

CC_DISPOSITION_CODE_ENABLE_n

Parameter Name Example	CC_DISPOSITION_CODE_ENABLE_1, CC_DISPOSITION_CODE_ENABLE_2, ..., CC_DISPOSITION_CODE_ENABLE_16
Value Format	BOOLEAN
Description	Specifies whether to enable the Disposition Code.
Value Range	<ul style="list-style-type: none"> • Y: Enable • N: Disable
Default Value	N
Web User Interface Reference	Disposition Code

CC_CUSTOMER_ORG_TRACE_ENABLE_n

Parameter Name Example	CC_CUSTOMER_ORG_TRACE_ENABLE_1, CC_CUSTOMER_ORG_TRACE_ENABLE_2, ..., CC_CUSTOMER_ORG_TRACE_ENABLE_16
Value Format	BOOLEAN
Description	Specifies whether to enable the Customer Originated Trace.
Value Range	<ul style="list-style-type: none"> • Y: Enable • N: Disable
Default Value	N
Web User Interface Reference	Customer Originated Trace

CC_HOTELING_EVENT_n

Parameter Name Example	CC_HOTELING_EVENT_1, CC_HOTELING_EVENT_2, ..., CC_HOTELING_EVENT_16
-------------------------------	---

Value Format	BOOLEAN
Description	Specifies whether to enable the Hoteling Event.
Value Range	<ul style="list-style-type: none"> • Y: Enable • N: Disable
Default Value	N
Web User Interface Reference	Hoteling Event

HOTELING_USERID_n

Parameter Name Example	HOTELING_USERID_1, HOTELING_USERID_2, ..., HOTELING_USERID_16
Value Format	STRING
Description	Specifies the authentication ID required to access the Hoteling service.
Value Range	Max. 32 characters
Default Value	Empty string
Web User Interface Reference	- User ID

HOTELING_PASSWORD_n

Parameter Name Example	HOTELING_PASSWORD_1, HOTELING_PASSWORD_2, ..., HOTELING_PASSWORD_16
Value Format	STRING
Description	Specifies the authentication password required to access the Hoteling service.
Value Range	Max. 128 characters
Default Value	Empty string
Web User Interface Reference	- Password

CC_STATUS_EVENT_ENABLE_n

Parameter Name Example	CC_STATUS_EVENT_ENABLE_1, CC_STATUS_EVENT_ENABLE_2, ..., CC_STATUS_EVENT_ENABLE_16
Value Format	BOOLEAN
Description	Specifies whether to enable the Status Event.
Value Range	<ul style="list-style-type: none"> • Y: Enable • N: Disable
Default Value	N
Web User Interface Reference	Status Event

5.3.15 SNMP Settings

Note

- Changing SNMP setting may require restarting the unit.

SNMP_ENABLE

Value Format	BOOLEAN
Description	Specifies whether to enable SNMP feature.
Value Range	<ul style="list-style-type: none"> • Y: Enable SNMP • N: Disable
Default Value	N

SNMP_TRUST_IP

Value Format	STRING
Description	Specifies the IP address or FQDN of the trusted SNMP server.
Value Range	Max. 256 characters
Default Value	Empty string

SNMP_TRUST_PORT

Value Format	INTEGER
Description	Specifies the port of the trusted SNMP server.
Value Range	1–65535
Default Value	161

SNMP_RO_COMMUNITY_STRING

Value Format	STRING
Description	Specifies the community name for read-only.
Value Range	Max. 32 characters
Default Value	Empty string

SNMP_SECURITY_TYPE

Value Format	INTEGER
Description	Specifies the security type of SNMPv3.
Value Range	0: noAuthNoPriv 1: AuthNoPriv 2: AuthPriv
Default Value	0

SNMP_SECURITY_USER

Value Format	STRING
---------------------	--------

Description	Specifies the security user ID for authentication and encryption of SNMPv3.
Value Range	Max. 32 characters
Default Value	Empty string

SNMP_AUTH_TYPE

Value Format	INTEGER
Description	Specifies the authentication type of SNMPv3.
Value Range	0: MD5 1: SHA
Default Value	0

SNMP_AUTH_PASSWORD

Value Format	STRING
Description	Specifies the authentication password of SNMPv3.
Value Range	0, 8–64 characters
Default Value	Empty string

SNMP_ENCRYPT_TYPE

Value Format	INTEGER
Description	Specifies the encryption type of SNMPv3.
Value Range	0: DES 1: AES
Default Value	1

SNMP_ENCRYPT_PASSWORD

Value Format	STRING
Description	Specifies the encryption password of SNMPv3.
Value Range	0, 8–64 characters
Default Value	Empty string

5.3.16 Multicast Paging Settings

MPAGE_ADDR_m

Parameter Name Example	MPAGE_ADDR1, MPAGE_ADDR2, ..., MPAGE_ADDR5
Value Format	IPADDR
Description	Specifies the address for multi-cast paging for each channel group. (m=1–5, the channel group) {Priority: 5 > 4 > 3, 2, 1 (depending on the configuration)}
Value Range	224.0.0.0–239.255.255.255
Default Value	Empty string

5.3.16 Multicast Paging Settings

Web User Interface Reference	IPv4 Address (Group 1–5)
-------------------------------------	--------------------------

MPAGE_IPV6_ADDRm

Parameter Name Example	MPAGE_IPV6_ADDR1, MPAGE_IPV6_ADDR2, ..., MPAGE_IPV6_ADDR5
Value Format	IPADDR-V6
Description	Specifies the IPv6 address for multi-cast paging for each channel group. (m=1–5, the channel group) {Priority: 5 > 4 > 3, 2, 1 (depending on the configuration)}
Value Range	FF00::/8
Default Value	Empty string
Web User Interface Reference	IPv6 Address (Group 1–5)

MPAGE_PORTm

Parameter Name Example	MPAGE_PORT1, MPAGE_PORT2, ..., MPAGE_PORT5
Value Format	INTEGER
Description	Specifies the port number for multi-cast paging for each channel group. (m=1–5, the channel group)
Value Range	0–65535 (0: not used)
Default Value	0
Web User Interface Reference	Port (Group 1–5)

MPAGE_PRIORITYm

Parameter Name Example	MPAGE_PRIORITY1, MPAGE_PRIORITY2, MPAGE_PRIORITY3
Value Format	INTEGER
Description	Specifies the priority of the low priority channel group. (m=1–3) The priority of multi-cast paging group 1–3 is lower than the talking. Priority 4 is higher than priority 5.
Value Range	4,5 (Talk > 4 > 5)
Default Value	5
Web User Interface Reference	Priority (Group 1–3)

MPAGE_LABELm

Parameter Name Example	MPAGE_LABEL1, MPAGE_LABEL2, ..., MPAGE_LABEL5
Value Format	STRING
Description	Specifies a label for each channel group. (m=1–5, the channel group)
Value Range	Max. 24 characters
Default Value	Empty string

Web User Interface Reference	Label (Group 1–5)
------------------------------	-------------------

MPAGE_SEND_ENABLE_m

Parameter Name Example	MPAGE_SEND_ENABLE1, MPAGE_SEND_ENABLE2, ..., MPAGE_SEND_ENABLE5
Value Format	BOOLEAN
Description	Specifies the sending multi-cast paging. (m=1–5, the channel group)
Value Range	<ul style="list-style-type: none"> • Y: Enable • N: Disable
Default Value	N
Web User Interface Reference	Enable Transmission (Group 1–5)

MPAGE_CODEC

Value Format	INTEGER
Description	Specifies the codec for multi-cast paging.
Value Range	0 : "G722" 1 : "PCMA" 2 : – 3 : "G729A" 4 : "PCMU"
Default Value	0

MPAGE_SP_VOL_EMERGENCY

Value Format	INTEGER
Description	Specifies the speaker level for new received multi-cast paging (emergency channel).
Value Range	0–8 0: No control
Default Value	0

MPAGE_SP_VOL_PRIORITY

Value Format	INTEGER
Description	Specifies the speaker level for new received multi-cast paging (priority channel).
Value Range	0–8 0: No control
Default Value	0

MPAGE_DND_ENABLE

Value Format	BOOLEAN
Description	Specifies the DND setting (on/off) for multi-cast paging.

5.3.17 NTP Settings

Value Range	<ul style="list-style-type: none">• Y: Enable DND for Multi-cast paging• N: Disable DND for Multi-cast paging
Default Value	N

MPAGE_FUNCKEY_ENABLE

Value Format	BOOLEAN
Description	Specifies whether to enable or disable the multicast paging key in function menu.
Value Range	<ul style="list-style-type: none">• Y: Enable• N: Disable
Default Value	N

5.3.17 NTP Settings

NTP_ADDR

Value Format	STRING
Description	Specifies the IP address or FQDN of NTP server.
Value Range	Max. 256 characters
Default Value	Empty string
Web User Interface Reference	Server Address

TIME_SYNC_INTVL

Value Format	INTEGER
Description	Specifies the interval, in seconds, to resynchronize after having detected no reply from the NTP server.
Value Range	10–86400
Default Value	60

TIME_QUERY_INTVL

Value Format	INTEGER
Description	Specifies the interval, in seconds, between synchronizations with the NTP server.
Value Range	10–86400
Default Value	43200
Web User Interface Reference	Synchronization Interval (Synchronisation Interval)

5.3.18 Time Settings

LOCAL_TIME_ZONE_POSIX

Value Format	STRING
---------------------	--------

Description	<p>Specifies a IEEE 1003.1 (POSIX)-compliant local time zone definition (e.g., "EST+5 EDT,M4.1.0/2,M10.5.0/2").</p> <p>Note</p> <ul style="list-style-type: none"> If this parameter is specified, the following parameters are disabled, and operation will be based on this parameter. <ul style="list-style-type: none"> – <code>TIME_ZONE</code> – <code>DST_ENABLE</code> – <code>DST_OFFSET</code> – <code>DST_START_MONTH</code> – <code>DST_START_ORDINAL_DAY</code> – <code>DST_START_DAY_OF_WEEK</code> – <code>DST_START_TIME</code> – <code>DST_STOP_MONTH</code> – <code>DST_STOP_ORDINAL_DAY</code> – <code>DST_STOP_DAY_OF_WEEK</code> – <code>DST_STOP_TIME</code>
Value Range	Max. 70 characters
Default Value	Empty string

TIME_ZONE

Value Format	INTEGER
Description	Specifies the offset of local standard time from UTC (GMT), in minutes.

5.3.18 Time Settings

Value Range	-720–780 Note <ul style="list-style-type: none"> Only the following values are available: -720 (GMT -12:00), -660 (GMT -11:00), -600 (GMT -10:00), -540 (GMT -09:00), -480 (GMT -08:00), -420 (GMT -07:00), -360 (GMT -06:00), -300 (GMT -05:00), -240 (GMT -04:00), -210 (GMT -03:30), -180 (GMT -03:00), -120 (GMT -02:00), -60 (GMT -01:00), 0 (GMT), 60 (GMT +01:00), 120 (GMT +02:00), 180 (GMT +03:00), 210 (GMT +03:30), 240 (GMT +04:00), 270 (GMT +04:30), 300 (GMT +05:00), 330 (GMT +05:30), 345 (GMT +05:45), 360 (GMT +06:00), 390 (GMT +06:30), 420 (GMT +07:00), 480 (GMT +08:00), 540 (GMT +09:00), 570 (GMT +09:30), 600 (GMT +10:00), 660 (GMT +11:00), 720 (GMT +12:00), 780 (GMT +13:00) If your location is west of Greenwich (0 [GMT]), the value should be minus. For example, the value for New York City, U.S.A. is "-300" (Eastern Standard Time being 5 hours behind GMT). This parameter is disabled when the "LOCAL_TIME_ZONE_POSIX" parameter is specified.
Default Value	0
Web User Interface Reference	Time Zone

DST_ENABLE

Value Format	BOOLEAN
Description	Specifies whether to enable DST (Summer Time). Note <ul style="list-style-type: none"> This parameter is disabled when the "LOCAL_TIME_ZONE_POSIX" parameter is specified.
Value Range	<ul style="list-style-type: none"> Y (Enable DST [Summer Time]) N (Disable DST [Summer Time])
Default Value	N
Web User Interface Reference	Enable DST (Enable Summer Time)

DST_OFFSET

Value Format	INTEGER
Description	Specifies the amount of time, in minutes, to change the time when "DST_ENABLE" is set to "Y". Note <ul style="list-style-type: none"> This parameter is disabled when the "LOCAL_TIME_ZONE_POSIX" parameter is specified.

Value Range	0–720 Note <ul style="list-style-type: none">This parameter is usually set to "60".
Default Value	60
Web User Interface Reference	DST Offset (Summer Time Offset)

DST_START_MONTH

Value Format	INTEGER
Description	Specifies the month in which DST (Summer Time) starts. Note <ul style="list-style-type: none">This parameter is disabled when the "LOCAL_TIME_ZONE_POSIX" parameter is specified.
Value Range	1–12
Default Value	3
Web User Interface Reference	Month

DST_START_ORDINAL_DAY

Value Format	INTEGER
Description	Specifies the number of the week on which DST (Summer Time) starts. The actual start day is specified in "DST_START_DAY_OF_WEEK". For example, to specify the second Sunday, specify "2" in this parameter, and "0" in the next parameter. Note <ul style="list-style-type: none">This parameter is disabled when the "LOCAL_TIME_ZONE_POSIX" parameter is specified.
Value Range	1–5 – 1: the first week of the month – 2: the second week of the month – 3: the third week of the month – 4: the fourth week of the month – 5: the last week of the month
Default Value	2
Web User Interface Reference	Day of Week

DST_START_DAY_OF_WEEK

Value Format	INTEGER
---------------------	---------

5.3.18 Time Settings

Description	Specifies the day of the week on which DST (Summer Time) starts. Note <ul style="list-style-type: none">This parameter is disabled when the "LOCAL_TIME_ZONE_POSIX" parameter is specified.
Value Range	0–6 <ul style="list-style-type: none">– 0: Sunday– 1: Monday– 2: Tuesday– 3: Wednesday– 4: Thursday– 5: Friday– 6: Saturday
Default Value	0
Web User Interface Reference	Day of Week

DST_START_TIME

Value Format	INTEGER
Description	Specifies the start time of DST (Summer Time) in minutes after 12:00 AM. Note <ul style="list-style-type: none">This parameter is disabled when the "LOCAL_TIME_ZONE_POSIX" parameter is specified.
Value Range	0–1439
Default Value	120
Web User Interface Reference	Time

DST_STOP_MONTH

Value Format	INTEGER
Description	Specifies the month in which DST (Summer Time) ends. Note <ul style="list-style-type: none">This parameter is disabled when the "LOCAL_TIME_ZONE_POSIX" parameter is specified.
Value Range	1–12
Default Value	10
Web User Interface Reference	Month

DST_STOP_ORDINAL_DAY

Value Format	INTEGER
---------------------	---------

Description	Specifies the number of the week on which DST (Summer Time) ends. The actual end day is specified in " DST_STOP_DAY_OF_WEEK ". For example, to specify the second Sunday, specify "2" in this parameter, and "0" in the next parameter. Note <ul style="list-style-type: none"> This parameter is disabled when the "LOCAL_TIME_ZONE_POSIX" parameter is specified.
Value Range	1–5 <ul style="list-style-type: none"> – 1: the first week of the month – 2: the second week of the month – 3: the third week of the month – 4: the fourth week of the month – 5: the last week of the month
Default Value	2
Web User Interface Reference	Day of Week

DST_STOP_DAY_OF_WEEK

Value Format	INTEGER
Description	Specifies the day of the week on which DST (Summer Time) ends. Note <ul style="list-style-type: none"> This parameter is disabled when the "LOCAL_TIME_ZONE_POSIX" parameter is specified.
Value Range	0–6 <ul style="list-style-type: none"> – 0: Sunday – 1: Monday – 2: Tuesday – 3: Wednesday – 4: Thursday – 5: Friday – 6: Saturday
Default Value	0
Web User Interface Reference	Day of Week

DST_STOP_TIME

Value Format	INTEGER
---------------------	---------

Description	Specifies the end time of DST (Summer Time) in minutes after 12:00 AM. Note <ul style="list-style-type: none">This parameter is disabled when the "LOCAL_TIME_ZONE_POSIX" parameter is specified.
Value Range	0–1439
Default Value	120
Web User Interface Reference	Time

5.3.19 Network Phonebook (Common)

ONLY_NPB_ENABLE

Value Format	BOOLEAN
Description	Specifies whether to be available the unit phonebook when the network phonebook is enabled.
Value Range	<ul style="list-style-type: none"> Y: Not use unit phonebook N: Use unit phonebook
Default Value	N

NETWORK_SEARCH_ENABLE

Value Format	BOOLEAN
Description	Specifies whether to perform the phonebook search at the time of the receiving the incoming or the searching the received log.
Value Range	<ul style="list-style-type: none"> Y: Enable phonebook search N: Disable
Default Value	N

5.3.20 Language Settings

AVAILABLE_LANGUAGE

Value Format	STRING
Description	Specifies the selectable language on the unit.
Value Range	en, es, fr, de, it, da, nl, sv, fi, el, hu, pt, pl, sk, cs, sh, ru, uk, tr, no, ro, ct, kk, me → see 4.4.1.1 Selectable Language
Web User Interface Reference	IP Phone

DEFAULT_LANGUAGE

Value Format	STRING
Description	Specifies the default language on the unit.

Value Range	en, es, fr, de, it, da, nl, sv, fi, el, hu, pt, pl, sk, cs, sh, ru, uk, tr, no, ro, ct, kk, me → see 4.4.1.1 Selectable Language
Default Value	en
Web User Interface Reference	IP Phone

LANGUAGE_PATHx

Parameter Name Example	LANGUAGE_PATH1, LANGUAGE_PATH2, ..., LANGUAGE_PATH10
Value Format	STRING
Description	Specifies the URI of the language file. x=1–10
Value Range	Max. 384 characters Note <ul style="list-style-type: none"> For details about the formats, see 2.1.3 Server Address Formats.
Default Value	Empty string

LANGUAGE_VERx

Parameter Name Example	LANGUAGE_VER1, LANGUAGE_VER2, ..., LANGUAGE_VER10
Value Format	STRING
Description	Specifies the version of the language file. x=1–10
Value Range	"00.000.000"–"15.999.999"
Default Value	Empty string

AVAILABLE_LANGUAGE_WEB

Value Format	STRING
Description	Specifies the selectable language on the Web.
Value Range	en, es, fr, de, it, nl, el, hu, pt, pl, sk, cs, sh, ru, uk, tr, ro, ct, kk, me → see 4.4.1.1 Selectable Language
Web User Interface Reference	Web Language

WEB_LANGUAGE

Value Format	STRING
Description	Specifies the default language on the unit.
Value Range	en, es, fr, de, it, nl, el, hu, pt, pl, sk, cs, sh, ru, uk, tr, ro, ct, kk, me → see 4.4.1.1 Selectable Language
Default Value	en
Web User Interface Reference	Web Language

WEB_LANGUAGE_PATHx

Parameter Name Example	WEB_LANGUAGE_PATH1, WEB_LANGUAGE_PATH2, ..., WEB_LANGUAGE_PATH10
Value Format	STRING
Description	Specifies the URI of the language file. x=1–10
Value Range	Max. 384 characters Note <ul style="list-style-type: none"> For details about the formats, see 2.1.3 Server Address Formats.
Default Value	Empty string

WEB_LANGUAGE_VERx

Parameter Name Example	WEB_LANGUAGE_VER1, WEB_LANGUAGE_VER2, ..., WEB_LANGUAGE_VER10
Value Format	STRING
Description	Specifies the version of the language file. x=1–10
Value Range	"00.000.000"–"15.999.999"
Default Value	Empty string

5.3.21 NAT Settings**STUN_SERV_ADDR**

Value Format	STRING
Description	Specifies the IP address or FQDN of the primary STUN server.
Value Range	Max. 256 characters
Default Value	Empty string
Web User Interface Reference	Server Address

STUN_SERV_PORT

Value Format	INTEGER
Description	Specifies the port of the primary STUN server.
Value Range	1–65535
Default Value	3478
Web User Interface Reference	Port

STUN_2NDSERV_ADDR

Value Format	STRING
Description	Specifies the IP address or FQDN of the secondary STUN server.

Value Range	Max. 256 characters
Default Value	Empty string

STUN_2NDSERV_PORT

Value Format	INTEGER
Description	Specifies the port number of the secondary STUN server.
Value Range	1–65535
Default Value	3478

STUN_INTVL

Value Format	INTEGER
Description	Specifies the interval of the sending binding request.
Value Range	60–86400
Default Value	300
Web User Interface Reference	Binding Interval

SIP_ADD_RPORT

Value Format	BOOLEAN
Description	Specifies whether to add the 'rport' parameter to the top Via header field value of requests generated.
Value Range	<ul style="list-style-type: none"> • Y: Enable Rport • N: Disable
Default Value	N
Web User Interface Reference	Enable Rport (RFC 3581)

PORT_PUNCH_INTVL

Value Format	INTEGER
Description	Specifies the interval, in seconds, between transmissions of the Keep Alive packet in order to maintain the NAT binding information for SIP packet.
Value Range	0, 10–300 0: Disable
Default Value	0
Web User Interface Reference	Enable Port Punching for SIP

RTP_PORT_PUNCH_INTVL

Value Format	INTEGER
Description	Specifies the interval, in seconds, between transmissions of the Keep Alive packet in order to maintain the NAT binding information for RTP packet.

5.3.22 SIP Settings

Value Range	0, 10–300 0: Disable
Default Value	0
Web User Interface Reference	Enable Port Punching for RTP

EXTERNAL_RTP_PORTx

Value Format	INTEGER
Description	x=1–48 Specifies the port number of the router in Static NAT status.
Value Range	0, 1024–59998 (only even ports) 0: Disable
Default Value	0

5.3.22 SIP Settings

SIP_USER_AGENT

Value Format	STRING
Description	Specifies the text string to send as the user agent in the headers of SIP messages.
Value Range	Max. 64 characters Note <ul style="list-style-type: none">• If "{mac}" is included in this parameter, it will be replaced with the unit's MAC address in lower-case.• If "{MAC}" is included in this parameter, it will be replaced with the unit's MAC address in upper-case.• If "{MODEL}" is included in this parameter, it will be replaced with the unit's model name.• If "{fwver}" is included in this parameter, it will be replaced with the firmware version of the unit.• If "{sipver}" is included in this parameter, it will be replaced with the SIP software version of the unit.
Default Value	Panasonic-{MODEL}/{fwver} ({mac})
Web User Interface Reference	User Agent

PHONE_NUMBER_n

Parameter Name Example	PHONE_NUMBER_1, PHONE_NUMBER_2, ..., PHONE_NUMBER_16
Value Format	STRING

Description	Specifies the phone number to use as the user ID required for registration to the SIP registrar server. Note <ul style="list-style-type: none"> When registering using a user ID that is not a phone number, you should use the "SIP_URI_n" setting.
Value Range	Max. 32 characters
Default Value	Empty string
Web User Interface Reference	Phone Number

SIP_URI_n

Parameter Name Example	SIP_URI_1, SIP_URI_2, ..., SIP_URI_16
Value Format	STRING
Description	Specifies the unique ID used by the SIP registrar server, which consists of "sip:", a user part, the "@" symbol, and a host part, for example, "sip:user@example.com", "2405551111_1". Note <ul style="list-style-type: none"> When registering using a user ID that is not a phone number, you should use this setting. In a SIP URI, the user part ("user" in the example above) can contain up to 63 characters, and the host part ("example.com" in the example above) can contain up to 316 characters.
Value Range	Max. 384 characters
Default Value	Empty string
Web User Interface Reference	SIP URI

SIP_RGSTR_ADDR_n

Parameter Name Example	SIP_RGSTR_ADDR_1, SIP_RGSTR_ADDR_2, ..., SIP_RGSTR_ADDR_16
Value Format	STRING
Description	Specifies the IP address or FQDN of the SIP registrar server.
Value Range	Max. 256 characters
Default Value	Empty string
Web User Interface Reference	Registrar Server Address

SIP_RGSTR_PORT_n

Parameter Name Example	SIP_RGSTR_PORT_1, SIP_RGSTR_PORT_2, ..., SIP_RGSTR_PORT_16
Value Format	INTEGER
Description	Specifies the port number to use for communication with the SIP registrar server.

5.3.22 SIP Settings

Value Range	1–65535
Default Value	5060
Web User Interface Reference	Registrar Server Port

SIP_PRXY_ADDR_n

Parameter Name Example	SIP_PRXY_ADDR_1, SIP_PRXY_ADDR_2, ..., SIP_PRXY_ADDR_16
Value Format	STRING
Description	Specifies the IP address or FQDN of the SIP proxy server.
Value Range	Max. 256 characters
Default Value	Empty string
Web User Interface Reference	Proxy Server Address

SIP_PRXY_PORT_n

Parameter Name Example	SIP_PRXY_PORT_1, SIP_PRXY_PORT_2, ..., SIP_PRXY_PORT_16
Value Format	INTEGER
Description	Specifies the port number to use for communication with the SIP proxy server.
Value Range	1–65535
Default Value	5060
Web User Interface Reference	Proxy Server Port

SIP_PRSNC_ADDR_n

Parameter Name Example	SIP_PRSNC_ADDR_1, SIP_PRSNC_ADDR_2, ..., SIP_PRSNC_ADDR_16
Value Format	STRING
Description	Specifies the IP address or FQDN of the SIP presence server.
Value Range	Max. 256 characters
Default Value	Empty string
Web User Interface Reference	Presence Server Address

SIP_PRSNC_PORT_n

Parameter Name Example	SIP_PRSNC_PORT_1, SIP_PRSNC_PORT_2, ..., SIP_PRSNC_PORT_16
Value Format	INTEGER
Description	Specifies the port number to use for communication with the SIP presence server.
Value Range	1–65535
Default Value	5060
Web User Interface Reference	Presence Server Port

SIP_OUTPROXY_ADDR_n

Parameter Name Example	SIP_OUTPROXY_ADDR_1, SIP_OUTPROXY_ADDR_2, ..., SIP_OUTPROXY_ADDR_16
Value Format	STRING
Description	Specifies the IP address or FQDN of the SIP outbound proxy server.
Value Range	Max. 256 characters
Default Value	Empty string
Web User Interface Reference	Outbound Proxy Server Address

SIP_OUTPROXY_PORT_n

Parameter Name Example	SIP_OUTPROXY_PORT_1, SIP_OUTPROXY_PORT_2, ..., SIP_OUTPROXY_PORT_16
Value Format	INTEGER
Description	Specifies the port number to use for communication with the SIP outbound proxy server.
Value Range	1–65535
Default Value	5060
Web User Interface Reference	Outbound Proxy Server Port

SIP_SVCDOMAIN_n

Parameter Name Example	SIP_SVCDOMAIN_1, SIP_SVCDOMAIN_2, ..., SIP_SVCDOMAIN_16
Value Format	STRING
Description	Specifies the domain name provided by your phone system dealer/ service provider. The domain name is the part of the SIP URI that comes after the "@" symbol.
Value Range	Max. 256 characters
Default Value	Empty string
Web User Interface Reference	Service Domain

SIP_AUTHID_n

Parameter Name Example	SIP_AUTHID_1, SIP_AUTHID_2, ..., SIP_AUTHID_16
Value Format	STRING
Description	Specifies the authentication ID required to access the SIP server.
Value Range	Max. 128 characters (except ", &, ', :, <, >, and space)
Default Value	Empty string
Web User Interface Reference	Authentication ID

SIP_PASS_n

Parameter Name Example	SIP_PASS_1, SIP_PASS_2, ..., SIP_PASS_16
-------------------------------	--

5.3.22 SIP Settings

Value Format	STRING
Description	Specifies the authentication password used to access the SIP server.
Value Range	Max. 128 characters (except ", &, ', :, <, >, and space)
Default Value	Empty string
Web User Interface Reference	Authentication Password

SIP_SRC_PORT_n

Parameter Name Example	SIP_SRC_PORT_1, SIP_SRC_PORT_2, ..., SIP_SRC_PORT_16
Value Format	INTEGER
Description	Specifies the source port number used by the unit for SIP communication.
Value Range	1024–49151 Note <ul style="list-style-type: none"> The SIP port number for each line must be unique.
Default Value	SIP_SRC_PORT_1="5060" SIP_SRC_PORT_2="5070" SIP_SRC_PORT_3="5080" SIP_SRC_PORT_4="5090" SIP_SRC_PORT_5="5100" SIP_SRC_PORT_6="5110" SIP_SRC_PORT_7="5120" SIP_SRC_PORT_8="5130" SIP_SRC_PORT_9="5140" SIP_SRC_PORT_10="5150" SIP_SRC_PORT_11="5160" SIP_SRC_PORT_12="5170" SIP_SRC_PORT_13="5180" SIP_SRC_PORT_14="5190" SIP_SRC_PORT_15="5200" SIP_SRC_PORT_16="5210"
Web User Interface Reference	Local SIP Port

DSCP_SIP_n

Parameter Name Example	DSCP_SIP_1, DSCP_SIP_2, ..., DSCP_SIP_16
Value Format	INTEGER
Description	Specifies the DSCP level of DiffServ applied to SIP packets.
Value Range	0–63
Default Value	0
Web User Interface Reference	SIP Packet QoS (DSCP)

SIP_DNSSRV_ENA_n

Parameter Name Example	SIP_DNSSRV_ENA_1, SIP_DNSSRV_ENA_2, ..., SIP_DNSSRV_ENA_16
Value Format	BOOLEAN
Description	Specifies whether to request the DNS server to translate domain names into IP addresses using the SRV record.
Value Range	<ul style="list-style-type: none"> • Y (Enable DNS SRV lookup) • N (Disable DNS SRV lookup) <p>Note</p> <ul style="list-style-type: none"> • If set to "Y", the unit will perform a DNS SRV lookup for a SIP registrar server, SIP proxy server, SIP outbound proxy server, or SIP presence server. • If set to "N", the unit will not perform a DNS SRV lookup for a SIP registrar server, SIP proxy server, SIP outbound proxy server, or SIP presence server.
Default Value	Y
Web User Interface Reference	Enable DNS SRV lookup

SIP_UDP_SRV_PREFIX_n

Parameter Name Example	SIP_UDP_SRV_PREFIX_1, SIP_UDP_SRV_PREFIX_2, ..., SIP_UDP_SRV_PREFIX_16
Value Format	STRING
Description	Specifies a prefix to add to the domain name when performing a DNS SRV lookup using UDP. <p>Note</p> <ul style="list-style-type: none"> • This setting is available only when "SIP_DNSSRV_ENA_n" is set to "Y".
Value Range	Max. 32 characters
Default Value	_sip._udp.
Web User Interface Reference	SRV lookup Prefix for UDP

SIP_TCP_SRV_PREFIX_n

Parameter Name Example	SIP_TCP_SRV_PREFIX_1, SIP_TCP_SRV_PREFIX_2, ..., SIP_TCP_SRV_PREFIX_16
Value Format	STRING
Description	Specifies a prefix to add to the domain name when performing a DNS SRV lookup using TCP. <p>Note</p> <ul style="list-style-type: none"> • This setting is available only when "SIP_DNSSRV_ENA_n" is set to "Y".

Value Range	Max. 32 characters
Default Value	_sip._tcp.
Web User Interface Reference	SRV lookup Prefix for TCP

REG_EXPIRE_TIME_n

Parameter Name Example	REG_EXPIRE_TIME_1, REG_EXPIRE_TIME_2, ..., REG_EXPIRE_TIME_16
Value Format	INTEGER
Description	Specifies the length of time, in seconds, that the registration remains valid. This value is set in the "Expires" header of the REGISTER request.
Value Range	1–4294967295
Default Value	3600
Web User Interface Reference	REGISTER Expires Timer

REG_INTERVAL_RATE_n

Parameter Name Example	REG_INTERVAL_RATE_1, REG_INTERVAL_RATE_2, ..., REG_INTERVAL_RATE_16
Value Format	INTEGER
Description	Specifies the percentage of the "expires" value after which to refresh registration by sending a new REGISTER message in the same dialog.
Value Range	1–100
Default Value	50

REG_RTX_INTVL_n

Parameter Name Example	REG_RTX_INTVL_1, REG_RTX_INTVL_2, ..., REG_RTX_INTVL_16
Value Format	INTEGER
Description	Specifies the interval, in seconds, between transmissions of the REGISTER request when a registration results in failure (server no reply or error reply).
Value Range	1–86400
Default Value	10

USE_DEL_REG_OPEN_n

Parameter Name Example	USE_DEL_REG_OPEN_1, USE_DEL_REG_OPEN_2, ..., USE_DEL_REG_OPEN_16
Value Format	BOOLEAN
Description	Specifies whether to enable cancelation before registration when, for example, the unit is turned on.

Value Range	<ul style="list-style-type: none"> • Y: Send un-REGISTER • N: Does not send
Default Value	N

USE_DEL_REG_CLOSE_n

Parameter Name Example	USE_DEL_REG_CLOSE_1, USE_DEL_REG_CLOSE_2, ..., USE_DEL_REG_CLOSE_16
Value Format	BOOLEAN
Description	Specifies whether to enable the cancelation of registration before the SIP function shuts down when, for example, the configuration has changed.
Value Range	<ul style="list-style-type: none"> • Y: Send un-REGISTER • N: Does not send
Default Value	N

SIP_SESSION_TIME_n

Parameter Name Example	SIP_SESSION_TIME_1, SIP_SESSION_TIME_2, ..., SIP_SESSION_TIME_16
Value Format	INTEGER
Description	Specifies the length of time, in seconds, that the unit waits before terminating SIP sessions when no reply to repeated requests is received. For details, refer to RFC 4028.
Value Range	0, 60–65535 (0: Disable)
Default Value	0
Web User Interface Reference	Enable Session Timer (RFC 4028)

SIP_SESSION_METHOD_n

Parameter Name Example	SIP_SESSION_METHOD_1, SIP_SESSION_METHOD_2, ..., SIP_SESSION_METHOD_16
Value Format	INTEGER
Description	Specifies the refreshing method of SIP sessions.
Value Range	0–2 – 0: reINVITE – 1: UPDATE – 2: AUTO
Default Value	0
Web User Interface Reference	Session Timer Method

SIP_TIMER_T1_n

Parameter Name Example	SIP_TIMER_T1_1, SIP_TIMER_T1_2, ..., SIP_TIMER_T1_16
-------------------------------	--

5.3.22 SIP Settings

Value Format	INTEGER
Description	Specifies the default interval, in milliseconds, between transmissions of SIP messages. For details, refer to RFC 3261.
Value Range	<ul style="list-style-type: none">• 250• 500• 1000• 2000• 4000
Default Value	500
Web User Interface Reference	T1 Timer

SIP_TIMER_T2_n

Parameter Name Example	SIP_TIMER_T2_1, SIP_TIMER_T2_2, ..., SIP_TIMER_T2_16
Value Format	INTEGER
Description	Specifies the maximum interval, in seconds, between transmissions of SIP messages. For details, refer to RFC 3261.
Value Range	<ul style="list-style-type: none">• 2• 4• 8• 16• 32
Default Value	4
Web User Interface Reference	T2 Timer

SIP_TIMER_T4_n

Parameter Name Example	SIP_TIMER_T4_1, SIP_TIMER_T4_2, ..., SIP_TIMER_T4_16
Value Format	INTEGER
Description	Specifies the maximum period, in seconds, that a message can remain on the network.
Value Range	<ul style="list-style-type: none">• 0• 1• 2• 3• 4• 5
Default Value	5

SIP_TIMER_B_n

Parameter Name Example	SIP_TIMER_B_1, SIP_TIMER_B_2, ..., SIP_TIMER_B_16
-------------------------------	---

Value Format	INTEGER
Description	Specifies the value of SIP timer B (INVITE transaction timeout timer), in milliseconds. For details, refer to RFC 3261.
Value Range	250–64000
Default Value	32000

SIP_TIMER_D_n

Parameter Name Example	SIP_TIMER_D_1, SIP_TIMER_D_2, ..., SIP_TIMER_D_16
Value Format	INTEGER
Description	Specifies the value of SIP timer D (wait time for answer resending), in milliseconds. For details, refer to RFC 3261.
Value Range	0, 250–64000
Default Value	5000

SIP_TIMER_F_n

Parameter Name Example	SIP_TIMER_F_1, SIP_TIMER_F_2, ..., SIP_TIMER_F_16
Value Format	INTEGER
Description	Specifies the value of SIP timer F (non-INVITE transaction timeout timer), in milliseconds. For details, refer to RFC 3261.
Value Range	250–64000
Default Value	32000

SIP_TIMER_H_n

Parameter Name Example	SIP_TIMER_H_1, SIP_TIMER_H_2, ..., SIP_TIMER_H_16
Value Format	INTEGER
Description	Specifies the value of SIP timer H (wait time for ACK reception), in milliseconds. For details, refer to RFC 3261.
Value Range	250–64000
Default Value	32000

SIP_TIMER_J_n

Parameter Name Example	SIP_TIMER_J_1, SIP_TIMER_J_2, ..., SIP_TIMER_J_16
Value Format	INTEGER
Description	Specifies the value of SIP timer J (wait time for non-INVITE request resending), in milliseconds. For details, refer to RFC 3261.
Value Range	0, 250–64000
Default Value	5000

SIP_100REL_ENABLE_n

Parameter Name Example	SIP_100REL_ENABLE_1, SIP_100REL_ENABLE_2, ..., SIP_100REL_ENABLE_16
Value Format	BOOLEAN
Description	Specifies whether to add the option tag 100rel to the "Supported" header of the INVITE message. For details, refer to RFC 3262.
Value Range	<ul style="list-style-type: none"> • Y (Enable 100rel function) • N (Disable 100rel function) <p>Note</p> <ul style="list-style-type: none"> • If set to "Y", the Reliability of Provisional Responses function will be enabled. The option tag 100rel will be added to the "Supported" header of the INVITE message and to the "Require" header of the "1xx" provisional message. • If set to "N", the option tag 100rel will not be used.
Default Value	Y
Web User Interface Reference	Enable 100rel (RFC 3262)

SIP_18X_RTX_INTVL_n

Parameter Name Example	SIP_18X_RTX_INTVL_1, SIP_18X_RTX_INTVL_2, ..., SIP_18X_RTX_INTVL_16
Value Format	INTEGER
Description	Specifies the retransmission interval, in seconds, for "18x" responses.
Value Range	0, 1–600 (0: Disable)
Default Value	0

SIP_SUBS_EXPIRE_n

Parameter Name Example	SIP_SUBS_EXPIRE_1, SIP_SUBS_EXPIRE_2, ..., SIP_SUBS_EXPIRE_16
Value Format	INTEGER
Description	Specifies the length of time, in seconds, that the subscription remains valid. This value is set in the "Expires" header of the SUBSCRIBE request.
Value Range	1–4294967295
Default Value	3600

SUB_INTERVAL_RATE_n

Parameter Name Example	SUB_INTERVAL_RATE_1, SUB_INTERVAL_RATE_2, ..., SUB_INTERVAL_RATE_16
Value Format	INTEGER

Description	Specifies the percentage of the "expires" value after which to refresh subscriptions by sending a new SUBSCRIBE message in the same dialog.
Value Range	1–100
Default Value	50

SUB_RTX_INTVL_n

Parameter Name Example	SUB_RTX_INTVL_1, SUB_RTX_INTVL_2, ..., SUB_RTX_INTVL_16
Value Format	INTEGER
Description	Specifies the interval, in seconds, between transmissions of SUBSCRIBE requests when a subscription results in failure (server no reply or error reply).
Value Range	1–86400
Default Value	10

SIP_P_PREFERRED_ID_n

Parameter Name Example	SIP_P_PREFERRED_ID_1, SIP_P_PREFERRED_ID_2, ..., SIP_P_PREFERRED_ID_16
Value Format	BOOLEAN
Description	Specifies whether to add the "P-Preferred-Identity" header to SIP messages.
Value Range	<ul style="list-style-type: none"> • Y (Add the "P-Preferred-Identity" header) • N (Do not add the "P-Preferred-Identity" header)
Default Value	N

SIP_PRIVACY_n

Parameter Name Example	SIP_PRIVACY_1, SIP_PRIVACY_2, ..., SIP_PRIVACY_16
Value Format	BOOLEAN
Description	Specifies whether to add the "Privacy" header to SIP messages.
Value Range	<ul style="list-style-type: none"> • Y (Add the "Privacy" header) • N (Do not add the "Privacy" header)
Default Value	N

ADD_USER_PHONE_n

Parameter Name Example	ADD_USER_PHONE_1, ADD_USER_PHONE_2, ..., ADD_USER_PHONE_16
Value Format	BOOLEAN
Description	Specifies whether to add "user=phone" to the SIP URI in SIP messages.

Value Range	<ul style="list-style-type: none"> • Y (Add "user=phone") • N (Do not add "user=phone") <p>Note</p> <ul style="list-style-type: none"> • SIP URI example: <ul style="list-style-type: none"> – "sip:1111@tokyo.example.com;user=phone", when set to "Y" – "sip:1111@tokyo.example.com", when set to "N"
Default Value	N

SIP_ANM_DISPNAME_n

Parameter Name Example	SIP_ANM_DISPNAME_1, SIP_ANM_DISPNAME_2, ..., SIP_ANM_DISPNAME_16
Value Format	INTEGER
Description	Specifies the text string to set as the display name in the "From" header when making anonymous calls.
Value Range	<ul style="list-style-type: none"> • 0 (Use normal display name) • 1 (Use "Anonymous" for display name) • 2 (Do not send a display name)
Default Value	1

SIP_ANM_USERNAME_n

Parameter Name Example	SIP_ANM_USERNAME_1, SIP_ANM_USERNAME_2, ..., SIP_ANM_USERNAME_16
Value Format	INTEGER
Description	Specifies the text string to set as the user name in the "From" header when making anonymous calls.
Value Range	<ul style="list-style-type: none"> • 0 (Use normal user name) • 1 (Use "anonymous" for user name) • 2 (Do not send a user name)
Default Value	0

SIP_ANM_HOSTNAME_n

Parameter Name Example	SIP_ANM_HOSTNAME_1, SIP_ANM_HOSTNAME_2, ..., SIP_ANM_HOSTNAME_16
Value Format	BOOLEAN
Description	Specifies whether to set an anonymous host name in the "From" header when making anonymous calls.
Value Range	<ul style="list-style-type: none"> • Y (Use "anonymous.invalid" for host name) • N (Use normal host name)

Default Value	N
---------------	---

SIP_DETECT_SSAF_n

Parameter Name Example	SIP_DETECT_SSAF_1, SIP_DETECT_SSAF_2, ..., SIP_DETECT_SSAF_16
Value Format	BOOLEAN
Description	Specifies whether to enable SSAF for the SIP servers (registrar server, proxy server, and presence server).
Value Range	<ul style="list-style-type: none"> Y (Enable SSAF) N (Disable SSAF) <p>Note</p> <ul style="list-style-type: none"> If set to "Y", the unit receives SIP messages only from the source addresses stored in the SIP servers (registrar server, proxy server, and presence server), and not from other addresses. However, if "SIP_OUTPROXY_ADDR_n" in 5.3.22 SIP Settings is specified, the unit also receives SIP messages from the source address stored in the SIP outbound proxy server.
Default Value	N
Web User Interface Reference	Enable SSAF (SIP Source Address Filter)

SIP_RCV_DET_HEADER_n

Parameter Name Example	SIP_RCV_DET_HEADER_1, SIP_RCV_DET_HEADER_2, ..., SIP_RCV_DET_HEADER_16
Value Format	BOOLEAN
Description	Specifies whether to check the user name part of the SIP URI in the "To" header when receiving the INVITE message with an incorrect target SIP URI.
Value Range	<ul style="list-style-type: none"> Y (Enable username check) N (Disable username check) <p>Note</p> <ul style="list-style-type: none"> If set to "Y", the unit will return an error reply when it receives the INVITE message with an incorrect target SIP URI. If set to "N", the unit will not check the user name part of the SIP URI in the "To" header.
Default Value	N

SIP_RCV_DET_REQURI_n

Parameter Name Example	SIP_RCV_DET_REQURI_1, SIP_RCV_DET_REQURI_2, ..., SIP_RCV_DET_REQURI_16
Value Format	BOOLEAN

Description	Specifies whether to check ReqURI that is the part of SIP URI in "To" header when INVITE with wrong target SIP URI is received.
Value Range	<ul style="list-style-type: none"> • Y • N
Default Value	N

SIP_CONTACT_ON_ACK_n

Parameter Name Example	SIP_CONTACT_ON_ACK_1, SIP_CONTACT_ON_ACK_2, ..., SIP_CONTACT_ON_ACK_16
Value Format	BOOLEAN
Description	Specifies whether to add the "Contact" header to SIP ACK message.
Value Range	<ul style="list-style-type: none"> • Y (Add the "Contact" header) • N (Do not add the "Contact" header)
Default Value	N

VOICE_MESSAGE_AVAILABLE

Value Format	BOOLEAN
Description	Specifies how the existence of voice messages is determined when a "Messages-Waiting: yes" message is received.
Value Range	<ul style="list-style-type: none"> • Y (Determines that voice messages exist when "Messages-Waiting: yes" is received with a "Voice-Message" line included.) • N (Determines that voice messages exist when "Messages-Waiting: yes" is received even without a "Voice-Message" line included.)
Default Value	Y

SIP_INVITE_EXPIRE_n

Parameter Name Example	SIP_INVITE_EXPIRE_1, SIP_INVITE_EXPIRE_2, ..., SIP_INVITE_EXPIRE_16
Value Format	INTEGER
Description	Specifies the period, in seconds, in which the INVITE message will expire.
Value Range	0, 60–65535 (0: Disable)
Default Value	0

SIP_FOVR_NORSP_n

Parameter Name Example	SIP_FOVR_NORSP_1, SIP_FOVR_NORSP_2, ..., SIP_FOVR_NORSP_16
Value Format	BOOLEAN
Description	Specifies whether to perform the fail-over process when the unit detects that the SIP server is not replying to SIP message.

Value Range	<ul style="list-style-type: none"> • Y (Enable fail-over) • N (Disable fail-over) <p>Note</p> <ul style="list-style-type: none"> • If set to "Y", the unit will try to use the other SIP servers via the DNS SRV and A records. • If set to "N", the unit will not try to use the other SIP servers.
Default Value	Y

SIP_FOVR_MAX_n

Parameter Name Example	SIP_FOVR_MAX_1, SIP_FOVR_MAX_2, ..., SIP_FOVR_MAX_16
Value Format	INTEGER
Description	Specifies the maximum number of servers (including the first [normal] server) used in the fail-over process.
Value Range	1–4
Default Value	2

SIP_FOVR_MODE_n

Parameter Name Example	SIP_FOVR_MODE_1, SIP_FOVR_MODE_2, ..., SIP_FOVR_MODE_16
Value Format	BOOLEAN
Description	Specifies whether INVITE/SUBSCRIBE will also follow the REGISTER Failover result.
Value Range	<ul style="list-style-type: none"> • Y (INVITE/SUBSCRIBE will follow the REGISTER Failover result.) • N (INVITE/SUBSCRIBE will not follow the REGISTER Failover result.)
Default Value	N

SIP_FOVR_DURATION_n

Parameter Name Example	SIP_FOVR_DURATION_1, SIP_FOVR_DURATION_2, ..., SIP_FOVR_DURATION_16
Value Format	INTEGER
Description	Specifies the number of transmission times for the REGISTER method at the Failover destination.
Value Range	0–255
Default Value	0

SIP_ADD_ROUTE_n

Parameter Name Example	SIP_ADD_ROUTE_1, SIP_ADD_ROUTE_2, ..., SIP_ADD_ROUTE_16
Value Format	BOOLEAN

Description	Specifies whether or not to add Route headers when setting OutBoundProxy. Note <ul style="list-style-type: none"> Route headers are not added when OutBoundProxy and other server settings are the same.
Value Range	<ul style="list-style-type: none"> Y (Route headers are added) N (Route headers are not added)
Default Value	Y

SIP_REQURI_PORT_n

Parameter Name Example	SIP_REQURI_PORT_1, SIP_REQURI_PORT_2, ..., SIP_REQURI_PORT_16
Value Format	BOOLEAN
Description	Specifies whether to add the port parameter to the Request-Line in the initial SIP request.
Value Range	<ul style="list-style-type: none"> Y (Add the port parameter) N (Do not add the port parameter) Note <ul style="list-style-type: none"> Request URI in REGISTER example: <ul style="list-style-type: none"> If set to "Y", the port parameter is added to the Request-Line, as follows: Request-Line: REGISTER sip:192.168.0.10:5060 SIP/2.0 If set to "N", the port parameter is not added to the Request-Line, as follows: Request-Line: REGISTER sip:192.168.0.10 SIP/2.0
Default Value	Y

ADD_EXPIRES_HEADER_n

Parameter Name Example	ADD_EXPIRES_HEADER_1, ADD_EXPIRES_HEADER_2, ..., ADD_EXPIRES_HEADER_16
Value Format	BOOLEAN
Description	Specifies whether to add an "Expires" header to REGISTER (adds an "expires" parameter to the "Contact" header).
Value Range	<ul style="list-style-type: none"> Y (Add Expires Header) N (Do not add Expires Header)
Default Value	N

ADD_TRANSPORT_UDP_n

Parameter Name Example	ADD_TRANSPORT_UDP_1, ADD_TRANSPORT_UDP_2, ..., ADD_TRANSPORT_UDP_16
Value Format	BOOLEAN

Description	Specifies whether to add the attribute "transport=udp" to the SIP header URI.
Value Range	<ul style="list-style-type: none"> • Y (Add Transport UDP) • N (Do not add Transport UDP)
Default Value	N

SIP_ADD_DIVERSION_n

Parameter Name Example	SIP_ADD_DIVERSION_1, SIP_ADD_DIVERSION_2, ..., SIP_ADD_DIVERSION_16
Value Format	INTEGER
Description	Specifies whether to add Diversion header information.
Value Range	0–2 – 0: Do not add Diversion header information – 1: Use own diversion information only for the Diversion header – 2: Add diversion information to existing Diversion header
Default Value	0

TRANSFER_RECALL_TIM

Value Format	INTEGER
Description	Specifies the time that the original call is resumed when the forwarding party does not response by Refer method for call transfer.
Value Range	0, 1–240
Default Value	0

SIGNAL_COMPRESSION_n

Parameter Name Example	SIGNAL_COMPRESSION_1, SIGNAL_COMPRESSION_2, ..., SIGNAL_COMPRESSION_16
Value Format	INTEGER
Description	Specifies whether to use signal compression. When using signal compression, select Required or Supported.
Value Range	<ul style="list-style-type: none"> • 0: Disable • 1: Enable (Required) • 2: Enable (Supported)
Default Value	0

MAX_BREADTH_n

Parameter Name Example	MAX_BREADTH_1, MAX_BREADTH_2, ..., MAX_BREADTH_16
Value Format	INTEGER
Description	Specifies the Max Breadth that is max Folk number at Proxy.
Value Range	0–99 (0: Not add max-breadth header)

Default Value	60
---------------	----

MUTIPART_BOUNDARY_DELIMITER_n

Parameter Name Example	MUTIPART_BOUNDARY_DELIMITER_1, MUTIPART_BOUNDARY_DELIMITER_2, ..., MUTIPART_BOUNDARY_DELIMITER_16
Value Format	STRING
Description	Specifies the strings that indicates the boundary for Multipart Bodies.
Value Range	Max. 70 characters
Default Value	boundary1

RFC5626_KEEPA_LIVE_ENABLE_n

Parameter Name Example	RFC5626_KEEPA_LIVE_ENABLE_1, RFC5626_KEEPA_LIVE_ENABLE_2, ..., RFC5626_KEEPA_LIVE_ENABLE_16
Value Format	BOOLEAN
Description	Specifies whether to use Keepalive that defined in RFC5626.
Value Range	<ul style="list-style-type: none"> • Y: Enable RFC5626 Keepalive • N: Disable
Default Value	N

RINGTONE_183_180_ENABLE_n

Parameter Name Example	RINGTONE_183_180_ENABLE_1, RINGTONE_183_180_ENABLE_2, ..., RINGTONE_183_180_ENABLE_16
Value Format	BOOLEAN
Description	Specifies whether to ring the local ringback tone when 180 is received after receiving 183 Early media.
Value Range	<ul style="list-style-type: none"> • Y: Performs ringback tone after early media • N: Does not perform
Default Value	N

SIP_403_REG_SUB_RTX_n

Parameter Name Example	SIP_403_REG_SUB_RTX_1, SIP_403_REG_SUB_RTX_2, ..., SIP_403_REG_SUB_RTX_16
Value Format	BOOLEAN
Description	Specifies whether or not to send a request when a 403 Forbidden reply is received from the server in response to a REGISTER or SUBSCRIBE.
Value Range	<ul style="list-style-type: none"> • Y (Send) • N (Do not send)

Default Value	N
---------------	---

SIP_FORK_MODE_n

Parameter Name Example	SIP_FORK_MODE_1, SIP_FORK_MODE_2, ..., SIP_FORK_MODE_16
Value Format	BOOLEAN
Description	Specifies whether to use SIP Fork.
Value Range	<ul style="list-style-type: none"> Y: Use SIP Fork N: Not use SIP Fork
Default Value	Y

AKA_AUTHENTICATION_ENABLE_n

Parameter Name Example	AKA_AUTHENTICATION_ENABLE_1, AKA_AUTHENTICATION_ENABLE_2, ..., AKA_AUTHENTICATION_ENABLE_16
Value Format	BOOLEAN
Description	Specifies whether to use AKA authentication.
Value Range	<ul style="list-style-type: none"> Y: Use AKA authentication N: Not use AKA authentication
Default Value	N

RFC2543_HOLD_ENABLE_n

Parameter Name Example	RFC2543_HOLD_ENABLE_1, RFC2543_HOLD_ENABLE_2, ..., RFC2543_HOLD_ENABLE_16
Value Format	BOOLEAN
Description	Specifies whether to enable the RFC 2543 Call Hold feature on this line.
Value Range	<ul style="list-style-type: none"> Y (Enable RFC 2543 Call Hold) N (Disable RFC 2543 Call Hold) <p>Note</p> <ul style="list-style-type: none"> If set to "Y", the "c=0.0.0.0" syntax will be set in SDP when sending a re-INVITE message to hold the call. If set to "N", the "c=x.x.x.x" syntax will be set in SDP.
Default Value	Y
Web User Interface Reference	Enable c=0.0.0.0 Hold (RFC 2543)

SIP_HOLD_ATTRIBUTE_n

Parameter Name Example	SIP_HOLD_ATTRIBUTE_1, SIP_HOLD_ATTRIBUTE_2, ..., SIP_HOLD_ATTRIBUTE_16
Value Format	INTEGER

5.3.22 SIP Settings

Description	Specifies whether to set "a=inactive " or not when the call is on hold.
Value Range	<ul style="list-style-type: none"> • 0: send only • 1: inactive
Default Value	0

SDP_USER_ID_n

Parameter Name Example	SDP_USER_ID_1, SDP_USER_ID_2, ..., SDP_USER_ID_16
Value Format	STRING
Description	Specifies the user ID used in the "o=" line field of SDP.
Value Range	Max. 32 characters
Default Value	Empty string

TELEVENT_PAYLOAD

Value Format	INTEGER
Description	<p>Specifies the RFC 2833 payload type for DTMF tones.</p> <p>Note</p> <ul style="list-style-type: none"> • This setting is available only when "DTMF_METHOD_n" is set to "0".
Value Range	96–127
Default Value	101
Web User Interface Reference	Telephone-event Payload Type

HOLD_SOUND_PATH_n

Parameter Name Example	HOLD_SOUND_PATH_1, HOLD_SOUND_PATH_2, ..., HOLD_SOUND_PATH_16
Value Format	INTEGER
Description	<p>Specifies whether the unit's hold tone or the network server's hold tone (Music on hold) is played when a party is put on hold.</p> <p>Note</p> <ul style="list-style-type: none"> • It is necessary to set the following parameters to play the unit's hold tone. <ul style="list-style-type: none"> – HOLD_TONE_FRQ – HOLD_TONE_GAIN
Value Range	<p>0–1</p> <ul style="list-style-type: none"> – 0: The unit's hold tone is played. – 1: The network server's hold tone (Music on hold) is played.
Default Value	0

KEEP_EARLYMEDIA_n

Parameter Name Example	KEEP_EARLYMEDIA_1, KEEP_EARLYMEDIA_2, ..., KEEP_EARLYMEDIA_16
Value Format	BOOLEAN
Description	Specifies whether to continue Early Media call or not when 18x without SDP is received after Early Media connection is established while making a call.
Value Range	<ul style="list-style-type: none"> • Y: Continues • N: Does not continue (Switch to ringback tone)
Default Value	N

RFC3327_SUPPORT_PATH

Value Format	BOOLEAN
Description	Specifies whether to add "supported: path" to support Path header.
Value Range	<ul style="list-style-type: none"> • Y: Adds supported: path • N: Does not add
Default Value	Y

RFC4244_SUPPORT_HISTORY

Value Format	BOOLEAN
Description	Specifies whether to add "supported: history" to support History info header.
Value Range	<ul style="list-style-type: none"> • Y: Adds supported: history • N: Does not add
Default Value	N

RFC3319_SUPPORT_JOIN

Value Format	BOOLEAN
Description	Specifies whether to add "supported: join" to support join header.
Value Range	<ul style="list-style-type: none"> • Y: Adds supported: join • N: Does not add
Default Value	N

RFC6947_DRAFT08_ALTC

Value Format	BOOLEAN
Description	Specifies whether to support RFC6947 draft08 when the attvalue is not attached after altc.
Value Range	<ul style="list-style-type: none"> • Y: Performs ALTC by Draft08 • N: Performs ALTC by RFC6947

Default Value	Y
---------------	---

RFC5627_SUPPORT_GRUU_n

Parameter Name Example	RFC5627_SUPPORT_GRUU_1, RFC5627_SUPPORT_GRUU_2, ..., RFC5627_SUPPORT_GRUU_16
Value Format	BOOLEAN
Description	Specifies whether to add "supported: gruu" to support join header.
Value Range	<ul style="list-style-type: none"> Y: Adds supported: gruu N: Does not add
Default Value	N

ESCAPECODE_CONVERSION

Value Format	BOOLEAN
Description	Specifies whether to convert "#" code to "%23".
Value Range	<ul style="list-style-type: none"> Y: Convert "#" code to "%23" N: Does not convert
Default Value	Y

SIP_REPLACE_ENABLE_n

Parameter Name Example	SIP_REPLACE_ENABLE_1, SIP_REPLACE_ENABLE_2, ..., SIP_REPLACE_ENABLE_16
Value Format	BOOLEAN
Description	Specifies whether to use "Replaces Header".
Value Range	<ul style="list-style-type: none"> Y: Use "Replaces Header" N: Do not use "Replaces Header"
Default Value	Y

SIP_INC_INVITE_RTP_MODE_n

Parameter Name Example	SIP_INC_INVITE_RTP_MODE_1, SIP_INC_INVITE_RTP_MODE_2, ..., SIP_INC_INVITE_RTP_MODE_16
Value Format	INTEGER
Description	Specifies whether to send RTP after receiving a second INVITE.
Value Range	<ul style="list-style-type: none"> 0: Start receiving RTP after receiving a second INVITE 1: Start sending/receiving RTP after receiving a second INVITE
Default Value	0

5.3.23 SIP-TLS Settings

SIP_TRANSPORT_n

Parameter Name Example	SIP_TRANSPORT_1, SIP_TRANSPORT_2, ..., SIP_TRANSPORT_16
Value Format	INTEGER
Description	Specifies which transport layer protocol to use for sending SIP packets.
Value Range	<ul style="list-style-type: none"> • 0 (UDP) • 1 (TCP) • 2 (TLS)
Default Value	0
Web User Interface Reference	Transport Protocol

SIP_TLS_MODE_n

Parameter Name Example	SIP_TLS_MODE_1, SIP_TLS_MODE_2, ..., SIP_TLS_MODE_16
Value Format	INTEGER
Description	Specifies the secure SIP protocol.
Value Range	<ul style="list-style-type: none"> • 0: SIPS • 1: SIP-TLS
Default Value	0
Web User Interface Reference	TLS Mode

SIP_TLS_RECONNECT_n

Parameter Name Example	SIP_TLS_RECONNECT_1, SIP_TLS_RECONNECT_2, ..., SIP_TLS_RECONNECT_16
Value Format	BOOLEAN
Description	Specifies whether to perform TLS reconnect after TLS session is disconnected.
Value Range	<ul style="list-style-type: none"> • Y: Performs TLS connection automatically • N: Does not perform
Default Value	Y

SIP_TLS_SRV_PREFIX_n

Parameter Name Example	SIP_TLS_SRV_PREFIX_1, SIP_TLS_SRV_PREFIX_2, ..., SIP_TLS_SRV_PREFIX_16
Value Format	STRING
Description	Specifies a prefix to add to the domain name when performing a DNS SRV lookup using TLS.
Value Range	Max. 32 characters

Default Value	_sips._tcp.
Web User Interface Reference	SRV lookup Prefix for TLS

SIP_TLS_VERIFY_n

Parameter Name Example	SIP_TLS_VERIFY_1, SIP_TLS_VERIFY_2, ..., SIP_TLS_VERIFY_16
Value Format	INTEGER
Description	Specifies whether to enable the verification of the root certificate.
Value Range	<ul style="list-style-type: none"> • 0: No verification • 1: Simple verification • 2: Precise verification
Default Value	0

SIP_TLS_ROOT_CERT_PATH

Value Format	STRING
Description	Specifies the URI where the root certificate is stored.
Value Range	Max. 384 characters Note <ul style="list-style-type: none"> • For details about the formats, see 2.1.3 Server Address Formats.
Default Value	Empty string

SIP_TLS_CLIENT_CERT_PATH

Value Format	STRING
Description	Specifies the URI where the client certificate is stored.
Value Range	Max. 384 characters Note <ul style="list-style-type: none"> • For details about the formats, see 2.1.3 Server Address Formats.
Default Value	Empty string

SIP_TLS_PKEY_PATH

Value Format	STRING
Description	Specifies the URI where the private key is stored.
Value Range	Max. 384 characters Note <ul style="list-style-type: none"> • For details about the formats, see 2.1.3 Server Address Formats.
Default Value	Empty string

SIP_TLS_RANDOM_PORT

Value Format	BOOLEAN
Description	Specifies whether to assign a random port (ephemeral port) number or a static port number. Note <ul style="list-style-type: none"> • All lines that use SIP-TLS are defined by this parameter. • UDP/TCP ports are unaffected by this parameter.
Value Range	<ul style="list-style-type: none"> • Y: Assign a random TLS port number • N: Assign a static TLS port number (Refer to SIP_SRC_PORT_n)
Default Value	Y

5.3.24 CODEC Settings

CODEC_G729_PARAM_n

Parameter Name Example	CODEC_G729_PARAM_1, CODEC_G729_PARAM_2, ..., CODEC_G729_PARAM_16
Value Format	INTEGER
Description	Specifies whether to add an attribute line, "a=fmtp:18 annexb=no", to SDP when the codec is set to "G729A".
Value Range	<ul style="list-style-type: none"> • 0: Do not add "a=fmtp:18 annexb=no" • 1: Add "a=fmtp:18 annexb=no"
Default Value	0

CODEC_ENABLEx_n

Parameter Name Example	CODEC_ENABLEx_1, CODEC_ENABLEx_2, ..., CODEC_ENABLEx_16
Value Format	BOOLEAN
Description	Specifies whether to enable the codec specified in the parameter list. Note <ul style="list-style-type: none"> • The "x" character in the parameter title should be changed to one of the following numbers, according to the codec to be changed. <ul style="list-style-type: none"> – 0: G.722 – 1: PCMA – 3: G.729A – 4: PCMU • For codec setting examples, see 2.5.1 Examples of Codec Settings.
Value Range	<ul style="list-style-type: none"> • Y (Enable) • N (Disable)

5.3.25 DTMF Settings

Default Value	Y
Web User Interface Reference	<ul style="list-style-type: none"> • G.722 Enable • PCMA Enable • G.729A Enable • PCMU Enable

CODEC_PRIORITYx_n

Parameter Name Example	CODEC_PRIORITYx_1, CODEC_PRIORITYx_2, ..., CODEC_PRIORITYx_16
Value Format	INTEGER
Description	<p>Specifies the priority order for the codec.</p> <p>Note</p> <ul style="list-style-type: none"> • The "x" character in the parameter title should be changed to one of the following numbers, according to the codec to be changed. <ul style="list-style-type: none"> – 0: G.722 – 1: PCMA – 3: G.729A – 4: PCMU • For codec setting examples, see 2.5.1 Examples of Codec Settings.
Value Range	1–255
Default Value	1
Web User Interface Reference	<ul style="list-style-type: none"> • G.722 Priority • PCMA Priority • G.729A Priority • PCMU Priority

CODEC_G711_REQ

Value Format	INTEGER
Description	Specifies whether to automatically select "PCMU" as the codec when a codec other than "PCMU" is selected.
Value Range	<ul style="list-style-type: none"> • 0: Do not set "PCMU" • 1: Set "PCMU"
Default Value	1

5.3.25 DTMF Settings

DTMF_METHOD_n

Parameter Name Example	DTMF_METHOD_1, DTMF_METHOD_2, ..., DTMF_METHOD_16
-------------------------------	---

Value Format	INTEGER
Description	Specifies the method to notify the DTMF.
Value Range	<ul style="list-style-type: none"> • 0: RFC2833 • 1: Inband • 2: SIP INFO <p>Note</p> <ul style="list-style-type: none"> • RFC2833 refers to Outband DTMF. • Inband refers to Inband DTMF.
Default Value	0
Web User Interface Reference	DTMF Type

OUTBANDDTMF_VOL

Value Format	INTEGER
Description	Specifies the volume (in decibels [dB]) of the DTMF tone using RFC 2833.
Value Range	-63–0
Default Value	-5

INBANDDTMF_VOL

Value Format	INTEGER
Description	Specifies the volume (in decibels [dB]) of in-band DTMF tones.
Value Range	-46–0
Default Value	-5

DTMF_SIGNAL_LEN

Value Format	INTEGER
Description	Specifies the length of the DTMF signal, in milliseconds.
Value Range	60–200
Default Value	180

DTMF_INTDIGIT_TIM

Value Format	INTEGER
Description	Specifies the interval, in milliseconds, between DTMF signals.
Value Range	60–200
Default Value	90

5.3.26 RTP/RTCP/RTCP-XR Settings

DSCP_RTP_n

Parameter Name Example	DSCP_RTP_1, DSCP_RTP_2, ..., DSCP_RTP_16
Value Format	INTEGER
Description	Specifies the DSCP level of DiffServ applied to RTP packets.
Value Range	0–63
Default Value	0
Web User Interface Reference	RTP Packet QoS (DSCP)

DSCP_RTCP_n

Parameter Name Example	DSCP_RTCP_1, DSCP_RTCP_2, ..., DSCP_RTCP_16
Value Format	INTEGER
Description	Specifies the DSCP level of DiffServ applied to RTCP/RTCP-XR packets.
Value Range	0–63
Default Value	0
Web User Interface Reference	RTCP Packet QoS (DSCP)

MAX_DELAY_n

Parameter Name Example	MAX_DELAY_1, MAX_DELAY_2, ..., MAX_DELAY_16
Value Format	INTEGER
Description	Specifies the maximum delay, in 10-millisecond units, of the jitter buffer.
Value Range	3–50 (× 10 ms) Note <ul style="list-style-type: none"> • This setting is subject to the following conditions: <ul style="list-style-type: none"> – This value must be greater than "NOM_DELAY" – This value must be greater than "MIN_DELAY" – "NOM_DELAY" must be greater than or equal to "MIN_DELAY"
Default Value	20

MIN_DELAY_n

Parameter Name Example	MIN_DELAY_1, MIN_DELAY_2, ..., MIN_DELAY_16
Value Format	INTEGER
Description	Specifies the minimum delay, in 10-millisecond units, of the jitter buffer.

Value Range	1 or 2 (× 10 ms) Note <ul style="list-style-type: none"> • This setting is subject to the following conditions: <ul style="list-style-type: none"> – This value must be less than or equal to "NOM_DELAY" – This value must be less than "MAX_DELAY" – "MAX_DELAY" must be greater than "NOM_DELAY"
Default Value	2

NOM_DELAY_n

Parameter Name Example	NOM_DELAY_1, NOM_DELAY_2, ..., NOM_DELAY_16
Value Format	INTEGER
Description	Specifies the initial delay, in 10-millisecond units, of the jitter buffer.
Value Range	1–7 (× 10 ms) Note <ul style="list-style-type: none"> • This setting is subject to the following conditions: <ul style="list-style-type: none"> – This value must be greater than or equal to "MIN_DELAY" – This value must be less than "MAX_DELAY"
Default Value	1

RTP_PORT_MIN

Value Format	INTEGER
Description	Specifies the lowest port number that the unit will use for RTP packets.
Value Range	1024–59598 (only even)
Default Value	16000
Web User Interface Reference	Minimum RTP Port Number

RTP_PORT_MAX

Value Format	INTEGER
Description	Specifies the highest port number that the unit will use for RTP packets.
Value Range	1424–59998 (only even)
Default Value	20000
Web User Interface Reference	Maximum RTP Port Number

RTP_PTIME

Value Format	INTEGER
Description	Specifies the interval, in milliseconds, between transmissions of RTP packets.

Value Range	<ul style="list-style-type: none"> • 20 • 30 • 40 • 60
Default Value	20
Web User Interface Reference	RTP Packet Time

RTP_TARGET_CHECK

Value Format	INTEGER
Description	Specifies the diagnose level for received RTP.
Value Range	<ul style="list-style-type: none"> • 0: diagnose destination IP Address and port • 1: diagnose destination IP address • 2: diagnose destination port • 3: diagnose nothing
Default Value	0

RTCP_ENABLE_n

Parameter Name Example	RTCP_ENABLE_1, RTCP_ENABLE_2, ..., RTCP_ENABLE_16
Value Format	BOOLEAN
Description	Specifies whether to enable or disable RTCP (Real-Time Transport Control Protocol). For details, refer to RFC 3550.
Value Range	<ul style="list-style-type: none"> • Y (Enable RTCP) • N (Disable RTCP)
Default Value	N
Web User Interface Reference	Enable RTCP

RTCP_INTVL_n

Parameter Name Example	RTCP_INTVL_1, RTCP_INTVL_2, ..., RTCP_INTVL_16
Value Format	INTEGER
Description	Specifies the interval, in seconds, between RTCP/RTCP-XR packets.
Value Range	5–65535
Default Value	5
Web User Interface Reference	RTCP&RTCP-XR Interval

RTCP_SEND_BY_SDP_n

Parameter Name Example	RTCP_SEND_BY_SDP_1, RTCP_SEND_BY_SDP_2, ..., RTCP_SEND_BY_SDP_16
Value Format	INTEGER

Description	Specifies whether to send RTCP signals by SDP (Session Description Protocol).
Value Range	0–1 <ul style="list-style-type: none"> – 0: Send RTCP signals using the value specified in "RTCP_INTVL_n", if the "RTCP_ENABLE_n" parameter is enabled. – 1: Send RTCP signals using the value specified in the SDP attribute "a=rtcp:".
Default Value	0

RTP_CLOSE_ENABLE_n

Parameter Name Example	RTP_CLOSE_ENABLE_1, RTP_CLOSE_ENABLE_2, ..., RTP_CLOSE_ENABLE_16
Value Format	BOOLEAN
Description	Specifies whether to enable processing to close held RTP sockets.
Value Range	<ul style="list-style-type: none"> • Y (Enable RTP Close) • N (Disable RTP Close)
Default Value	N

RTCPXR_ENABLE_n

Parameter Name Example	RTCPXR_ENABLE_1, RTCPXR_ENABLE_2, ..., RTCPXR_ENABLE_16
Value Format	BOOLEAN
Description	Specifies whether to enable or disable RTCP-XR.
Value Range	<ul style="list-style-type: none"> • Y: Enable RTCP-XR • N: Disable
Default Value	N
Web User Interface Reference	Enable RTCP-XR

5.3.27 SRTP Settings

SRTP_CONNECT_MODE_n

Parameter Name Example	SRTP_CONNECT_MODE_1, SRTP_CONNECT_MODE_2, ..., SRTP_CONNECT_MODE_16
Value Format	INTEGER
Description	Specifies the mode of SRTP feature.

5.3.27 SRTP Settings

Value Range	<ul style="list-style-type: none"> • 0: SRTP • 1: RTP/SRTP • 2: SRTP&RTP(Panasonic PBX only) <p>Note</p> <ul style="list-style-type: none"> • 0: Use only SRTP for outgoing and incoming calls. • 1: Use only RTP for outgoing calls, and RTP or SRTP for incoming calls. • 2: Use RTP or SRTP for both outgoing and incoming calls. This value is valid only when the unit is connected to a Panasonic PBX. "SRTP_MIX_TRANSFER_ENABLE_n" must also be set to "Y".
Default Value	1
Web User Interface Reference	SRTP Mode

SRTP_MIX_CONFERENCE_ENABLE_n

Parameter Name Example	SRTP_MIX_CONFERENCE_ENABLE_1, SRTP_MIX_CONFERENCE_ENABLE_2, ..., SRTP_MIX_CONFERENCE_ENABLE_16
Value Format	BOOLEAN
Description	Specifies whether to allow conferences where each participant can use either SRTP or RTP.
Value Range	<ul style="list-style-type: none"> • Y: Enable • N: Disable
Default Value	N
Web User Interface Reference	Enable Mixed SRTP & RTP by Conference

SRTP_MIX_TRANSFER_ENABLE_n

Parameter Name Example	SRTP_MIX_TRANSFER_ENABLE_1, SRTP_MIX_TRANSFER_ENABLE_2, ..., SRTP_MIX_TRANSFER_ENABLE_16
Value Format	BOOLEAN
Description	Specifies whether to allow call transfers between a user who is using SRTP and a user who is using RTP.
Value Range	<ul style="list-style-type: none"> • Y: Enable • N: Disable
Default Value	N
Web User Interface Reference	Enable Mixed SRTP & RTP by Transfer

SRTP_HELD_CALL_RTP_ENABLE

Value Format	BOOLEAN
---------------------	---------

Description	Specifies whether to allow playing the melody on hold over RTP on a call that is using SRTP.
Value Range	<ul style="list-style-type: none"> • Y: Enable • N: Disable
Default Value	Y

5.3.28 VQ Report by PUBLISH

VQREPORT_COLLECTOR_ADDRESS

Value Format	STRING
Description	Specifies the IP address or FQDN of the collector server.
Value Range	Max. 256 characters
Default Value	Empty string
Web User Interface Reference	Server Address

VQREPORT_COLLECTOR_PORT

Value Format	INTEGER
Description	Specifies the port of the collector server.
Value Range	1–65535
Default Value	5060
Web User Interface Reference	Port

VQREPORT_SEND

Value Format	INTEGER
Description	Specifies the sending type of the VQ report using PUBLISH.
Value Range	<ul style="list-style-type: none"> • 0: Disable • 1: End of Session Report Using PUBLISH • 2: Interval report Using PUBLISH • 3: Alert Report Using PUBLISH
Default Value	0
Web User Interface Reference	Enable PUBLISH

ALERT_REPORT_TRIGGER

Value Format	INTEGER
Description	Specifies the trigger to notify the VQ report.
Value Range	<ul style="list-style-type: none"> • 0: Warning • 1: Critical
Default Value	0
Web User Interface Reference	Alert Report Trigger

ALERT_REPORT_MOSQ_CRITICAL

Value Format	INTEGER
Description	Specifies the critical criteria to send VQ report at the time of occurring the MOSQ.
Value Range	0–40
Default Value	0
Web User Interface Reference	Threshold MOS-LQ (Critical)

ALERT_REPORT_MOSQ_WARNING

Value Format	INTEGER
Description	Specifies the warning criteria to send VQ report at the time of occurring the MOSQ.
Value Range	0–40
Default Value	0
Web User Interface Reference	Threshold MOS-LQ (Warning)

ALERT_REPORT_DELAY_CRITICAL

Value Format	INTEGER
Description	Specifies the critical criteria to send VQ report at the time of occurring the delay.
Value Range	0–2000
Default Value	0
Web User Interface Reference	Threshold Delay (Critical)

ALERT_REPORT_DELAY_WARNING

Value Format	INTEGER
Description	Specifies the warning criteria to send VQ report at the time of occurring the delay.
Value Range	0–2000
Default Value	0
Web User Interface Reference	Threshold Delay (Warning)

VQREPORT_SIGNAL_COMPRESSION

Value Format	BOOLEAN
Description	Specifies whether to use signal compression for sending VQ report.
Value Range	<ul style="list-style-type: none"> • Y: Enable • N: Disable
Default Value	N

5.3.29 uaCSTA Settings

UACSTA_ENABLE_n

Parameter Name Example	UACSTA_ENABLE_1, UACSTA_ENABLE_2, ..., UACSTA_ENABLE_16
Value Format	BOOLEAN
Description	Specifies whether to enable or disable the uaCSTA feature.
Value Range	<ul style="list-style-type: none"> • Y: Enable • N: Disable
Default Value	N

UACSTA_UNIQUE_ID

Value Format	STRING
Description	Specifies the SIP-URI for registering to CSTA server.
Value Range	Max. 64 characters
Default Value	Empty string

CSTA_PORT

Value Format	INTEGER
Description	Specifies the source port number used by the unit for uaCSTA communication.
Value Range	1–65535
Default Value	6060

CSTA_PRXY_ADDR

Value Format	STRING
Description	Specifies the IP address or FQDN of the proxy server for CSTA.
Value Range	Max. 256 characters
Default Value	Empty string

CSTA_PRXY_PORT

Value Format	INTEGER
Description	Specifies the port of the proxy server for CSTA.
Value Range	1–65535
Default Value	5060

CSTA_RGSTR_ADDR

Value Format	STRING
Description	Specifies the IP address or FQDN of the registrar server for CSTA.
Value Range	Max. 256 characters

Default Value	Empty string
---------------	--------------

CSTA_RGSTR_PORT

Value Format	INTEGER
Description	Specifies the port of the registrar server for CSTA.
Value Range	1–65535
Default Value	5060

CSTA_REG_EXPIRE_TIME

Value Format	INTEGER
Description	Specifies the length of time, in seconds, that the registration remains valid. This value is set in the "Expires" header of the REGISTER request for CSTA.
Value Range	1–4294967295
Default Value	3600

CSTA_TRANSPORT

Value Format	INTEGER
Description	Specifies which transport layer protocol to use for sending SIP packets.
Value Range	<ul style="list-style-type: none"> • 0: UDP • 1: TCP • 2: TLS
Default Value	0

CSTA_RGSTR_AUTHID

Value Format	STRING
Description	Specifies the authentication ID for received REGISTER.
Value Range	Max. 128 characters
Default Value	Empty string

CSTA_RGSTR_PASS

Value Format	STRING
Description	Specifies the authentication password for received REGISTER.
Value Range	Max. 128 characters
Default Value	Empty string

5.3.30 Telephone Settings

POWER_ON_DISPLAY_LOGO_PATH

Value Format	STRING
Description	Specifies URI for logo image file displayed when power is turned on. Note <ul style="list-style-type: none"> • Size: 480 × 272 • File type: JPEG, PNG, BMP, GIF
Value Range	Max. 384 characters Note <ul style="list-style-type: none"> • For details about the formats, see 2.1.3 Server Address Formats.
Default Value	Empty string

FIRSTDIGIT_TIM

Value Format	INTEGER
Description	Specifies the length of time, in seconds, within which the first digits of a dial number must be dialed.
Value Range	1–600 (s)
Default Value	30
Web User Interface Reference	First-digit Timeout

INTDIGIT_TIM

Value Format	INTEGER
Description	Specifies the length of time, in seconds, within which subsequent digits of a dial number must be dialed.
Value Range	1–15 (s)
Default Value	5
Web User Interface Reference	Inter-digit Timeout

POUND_KEY_DELIMITER_ENABLE

Value Format	BOOLEAN
Description	Specifies whether the # key is treated as a regular dialed digit or a delimiter, when dialed as or after the second digit.
Value Range	<ul style="list-style-type: none"> • Y (# is treated as the end of dialing delimiter) • N (# is treated as a regular dialed digit)
Default Value	Y
Web User Interface Reference	Enable # Key as delimiter

RINGTONE_SETTING_n

Parameter Name Example	RINGTONE_SETTING_1, RINGTONE_SETTING_2, ..., RINGTONE_SETTING_16
Value Format	INTEGER
Description	Specifies the ringtone to each line for a unit.
Value Range	1–32
Default Value	RINGTONE_SETTING_1=1, RINGTONE_SETTING_2=2, RINGTONE_SETTING_3=3, RINGTONE_SETTING_4=4, RINGTONE_SETTING_5=5, RINGTONE_SETTING_6=6, RINGTONE_SETTING_7=7, RINGTONE_SETTING_8=8, RINGTONE_SETTING_9=1, RINGTONE_SETTING_10=2, RINGTONE_SETTING_11=3, RINGTONE_SETTING_12=4, RINGTONE_SETTING_13=5, RINGTONE_SETTING_14=6, RINGTONE_SETTING_15=7, RINGTONE_SETTING_16=8

DISPLAY_NAME_REPLACE

Value Format	BOOLEAN
Description	Specifies whether the name saved in the phonebook is used in place of the name display if a matching entry is found.
Value Range	<ul style="list-style-type: none"> • Y (Enable Display Name Replace) • N (Disable Display Name Replace)
Default Value	Y

NUMBER_MATCHING_LOWER_DIGIT

Value Format	INTEGER
Description	Specifies the minimum number of digits with which to match a phonebook entry with an incoming call's caller ID.
Value Range	0–15
Default Value	7

NUMBER_MATCHING_UPPER_DIGIT

Value Format	INTEGER
Description	Specifies the maximum number of digits with which to match a phonebook entry with an incoming call's caller ID.
Value Range	0–15
Default Value	10

FLASH_RECALL_TERMINATE

Value Format	BOOLEAN
Description	Specifies the function of the FLASH/RECALL button during a conversation.

Value Range	<ul style="list-style-type: none"> • Y (Terminate) • N (EFA)
Default Value	Y

FLASHHOOK_CONTENT_TYPE

Value Format	STRING
Description	Specifies the type of signal sent when sending a flash hook event.
Value Range	<ul style="list-style-type: none"> • Signal • flashhook
Default Value	Signal

NUM_PLAN_PARKING

Value Format	STRING
Description	Specifies the call parking number.
Value Range	0–4 digits (0–9, *, #)
Default Value	Empty string
Web User Interface Reference	Call Park Number

CALLPARK_KEY_ENABLE

Value Format	BOOLEAN
Description	Specifies whether to display "Call Park" in the Call Parking Func menu.
Value Range	<ul style="list-style-type: none"> • Y: Enable • N: Disable
Default Value	N
Web User Interface Reference	Enable Call Park Key

NUM_PLAN_PARK_RETRIEVING

Value Format	STRING
Description	Specifies the park retrieve number.
Value Range	0–4 digits (0–9, *, #)
Default Value	Empty string
Web User Interface Reference	Park Retrieve Number

HOLD_RECALL_TIM

Value Format	INTEGER
Description	Specifies the duration of the hold recall timer. If set to "0", the function is disabled.
Value Range	0–240 (0: Disable)

Default Value	60
---------------	----

HOLD_TRANSFER_OPERATION

Value Format	BOOLEAN
Description	Specifies whether to transfer a call by Hold button.
Value Range	<ul style="list-style-type: none"> • Y: Enable (Press the Hold button to transfer a call.) talk → hold → 2nd talk → Transfer (or on-hook) • N: Disable (Press the Transfer button to transfer a call.) talk → transfer → 2nd talk → transfer (or on-hook)
Default Value	N

ONHOOK_TRANSFER_ENABLE

Value Format	BOOLEAN
Description	Specifies whether to enable on hook transfer when HOLD_TRANSFER_OPERATION="N" .
Value Range	<ul style="list-style-type: none"> • Y (Enable On-hook Transfer) • N (Disable On-hook Transfer)
Default Value	Y

ONHOOK_HOLD_TRNS_ENABLE

Value Format	BOOLEAN
Description	Specifies whether to enable on hook transfer when HOLD_TRANSFER_OPERATION="Y" .
Value Range	<ul style="list-style-type: none"> • Y (Enable On-hook Transfer) • N (Disable On-hook Transfer)
Default Value	N

BLIND_TRANSFER_ENABLE

Value Format	BOOLEAN
Description	Specifies whether to enable blind transfer.
Value Range	<ul style="list-style-type: none"> • Y: Enable • N: Disable
Default Value	Y

SYS_LOCK_ENABLE

Value Format	BOOLEAN
Description	Specifies whether to enable locking the unit.
Value Range	<ul style="list-style-type: none"> • Y: Enable • N: Disable

Default Value	N
Web User Interface Reference	Enable IP Phone Lock

SYS_LOCK_PASSWORD

Value Format	STRING
Description	Specifies the password for unlocking the unit.
Value Range	Null, 4 digits (0–9)
Default Value	Empty string
Web User Interface Reference	Password for Unlocking

PAUSE_INPUT_ENABLE

Value Format	BOOLEAN
Description	Specifies whether to enable or disable pause input.
Value Range	<ul style="list-style-type: none"> • Y: Enable • N: Disable
Default Value	N

NUM_PLAN_PICKUP_DIRECT

Value Format	STRING
Description	Specifies the feature number assigned to a BLF for performing call pickup.
Value Range	0–4 digits (0–9, *, #)
Default Value	Empty string
Web User Interface Reference	Directed Call Pickup

DISP_NUM_PHONEBOOK_ENABLE

Value Format	BOOLEAN
Description	Specifies whether the number of remaining items is displayed when a new item is registered in phonebook.
Value Range	<ul style="list-style-type: none"> • Y: Enable • N: Disable
Default Value	Y

WALLPAPER_WAIT_TIME

Value Format	INTEGER
Description	Specifies the time, in seconds, to wait for the screen saver to display.

5.3.30 Telephone Settings

Value Range	<ul style="list-style-type: none">• 0 (Do not display the screen saver)• 10• 30• 60• 180• 300
Default Value	0
Web User Interface Reference	Wait Time

CNIP_FROM_ENABLE

Value Format	BOOLEAN
Description	Specifies whether to use the "FROM" header or the "PAI" header in CNIP (Calling Number Identification Presentation).
Value Range	<ul style="list-style-type: none">• \mathcal{Y}: Use "FROM" header• \mathcal{N}: Use "PAI" header
Default Value	\mathcal{N}

IDLE_DISPLAY_TYPE

Value Format	INTEGER
Description	Specifies what is shown on the display in standby mode.
Value Range	<ul style="list-style-type: none">• 0: Off• 1: Phone Number• 2: Phone Number and Name• 3: Name <p>Note</p> <ul style="list-style-type: none">• "Name" is the display name for the line.
Default Value	3

BLF_DISPLAY_OFF_OUTGOING

Value Format	BOOLEAN
Description	Specifies whether to display the phone numbers of BLF keys or PAI after dialing.
Value Range	<ul style="list-style-type: none">• \mathcal{Y}: Do not display• \mathcal{N}: Display the phone numbers
Default Value	\mathcal{N}

SPLIT_HOLD_TRNS_ENABLE

Value Format	BOOLEAN
---------------------	---------

Description	Specifies whether to enable the Call Split feature by pressing the hold key while a call is either on transfer hold or conference hold.
Value Range	<ul style="list-style-type: none"> Y: Enable the Call Split feature by using the hold key N: Disable
Default Value	N

5.3.31 Flexible Key Settings

FLEX_BUTTON_FACILITY_ACTx

Parameter Name Example	FLEX_BUTTON_FACILITY_ACT1, FLEX_BUTTON_FACILITY_ACT2, ..., FLEX_BUTTON_FACILITY_ACT24
Value Format	STRING
Description	<p>x=1–24</p> <p>Specifies a particular Facility Action for the flexible key. No facility action will be taken for the button if the string is empty or invalid.</p> <p>Note</p> <ul style="list-style-type: none"> If this parameter is specified, "FLEX_BUTTON_QUICK_DIALx" should be an empty string.
Value Range	X_PANASONIC_IPTEL_LINE, X_PANASONIC_IPTEL_ONETOUCH, X_PANASONIC_IPTEL_ACD, X_PANASONIC_IPTEL_WRAPUP, X_PANASONIC_IPTEL_BLF, X_PANASONIC_IPTEL_LINESTATUS, X_PANASONIC_IPTEL_FORWARD, X_PANASONIC_IPTEL_PHONEBOOK, X_PANASONIC_IPTEL_CALLLOG, X_PANASONIC_IPTEL_PARARING, X_PANASONIC_IPTEL_HOTELING, X_PANASONIC_IPTEL_TRANSFER, X_PANASONIC_IPTEL_BLINDTRANSFER, X_PANASONIC_IPTEL_CONFERENCE, X_PANASONIC_IPTEL_DIRECTPICKUP, X_PANASONIC_IPTEL_CALLPARK, X_PANASONIC_IPTEL_PARKRETRIEVE, X_PANASONIC_IPTEL_NETWORKCAMERA, X_PANASONIC_IPTEL_APPLICATION,
Default Value	Empty string
Web User Interface Reference	Type

FLEX_BUTTON_FACILITY_ARGx

Parameter Name Example	FLEX_BUTTON_FACILITY_ARG1, FLEX_BUTTON_FACILITY_ARG2, ..., FLEX_BUTTON_FACILITY_ARG24
-------------------------------	---

Value Format	STRING
Description	x=1–24 Specifies an optional argument associated with the specified Facility Action for the flexible key.
Value Range	Max. 35 characters
Default Value	Empty string
Web User Interface Reference	Parameter

FLEX_BUTTON_LABELx

Parameter Name Example	FLEX_BUTTON_LABEL1, FLEX_BUTTON_LABEL2, ..., FLEX_BUTTON_LABEL24
Value Format	STRING
Description	x=1–24 Specifies the name of flexible key to be displayed on the screen.
Value Range	Max. 20 characters Note <ul style="list-style-type: none"> You can use Unicode characters for this setting.
Default Value	Empty string
Web User Interface Reference	Label Name

FLEX_BUTTON_QUICK_DIALx

Parameter Name Example	FLEX_BUTTON_QUICK_DIAL1, FLEX_BUTTON_QUICK_DIAL2, ..., FLEX_BUTTON_QUICK_DIAL24
Value Format	STRING
Description	x=1–24 Specifies a quick dial destination number to be used for the flexible key.
Value Range	Max. 32 digits (0–9, *, #)
Default Value	Empty string

LONG_PRESS_KEY_SETTING_ENABLE

Value Format	BOOLEAN
Description	Specifies whether to enable or disable the DSS key with a long press.
Value Range	<ul style="list-style-type: none"> Y: Enable N: Disable
Default Value	Y

5.3.32 DSS Key Settings

DSS_BUTTON_FACILITY_ACTx

Parameter Name Example	DSS_BUTTON_FACILITY_ACT1, DSS_BUTTON_FACILITY_ACT2, ..., DSS_BUTTON_FACILITY_ACT200
Value Format	STRING
Description	x=1–200 Specifies a particular Facility Action for the flexible key. No facility action will be taken for the button if the string is empty or invalid. Note <ul style="list-style-type: none"> If this parameter is specified, "DSS_BUTTON_QUICK_DIALx" should be an empty string.
Value Range	X_PANASONIC_IPTTEL_LINE, X_PANASONIC_IPTTEL_ONETOUCH, X_PANASONIC_IPTTEL_ACD, X_PANASONIC_IPTTEL_WRAPUP, X_PANASONIC_IPTTEL_BLF, X_PANASONIC_IPTTEL_LINESTATUS, X_PANASONIC_IPTTEL_FORWARD, X_PANASONIC_IPTTEL_PHONEBOOK, X_PANASONIC_IPTTEL_CALLLOG, X_PANASONIC_IPTTEL_PARARING, X_PANASONIC_IPTTEL_HOTELING, X_PANASONIC_IPTTEL_TRANSFER, X_PANASONIC_IPTTEL_BLINDTRANSFER, X_PANASONIC_IPTTEL_CONFERENCE, X_PANASONIC_IPTTEL_DIRECTPICKUP, X_PANASONIC_IPTTEL_CALLPARK, X_PANASONIC_IPTTEL_PARKRETRIEVE, X_PANASONIC_IPTTEL_NETWORKCAMERA, X_PANASONIC_IPTTEL_APPLICATION,
Default Value	Empty string
Web User Interface Reference	Type

DSS_BUTTON_FACILITY_ARGx

Parameter Name Example	DSS_BUTTON_FACILITY_ARG1, DSS_BUTTON_FACILITY_ARG2, ..., DSS_BUTTON_FACILITY_ARG200
Value Format	STRING
Description	x=1–200 Specifies an optional argument associated with the specified Facility Action for the flexible key.
Value Range	Max. 35 characters
Default Value	Empty string
Web User Interface Reference	Parameter

DSS_BUTTON_LABELx

Parameter Name Example	DSS_BUTTON_LABEL1, DSS_BUTTON_LABEL2, ..., DSS_BUTTON_LABEL200
Value Format	STRING
Description	x=1–200 Specifies the name of flexible key to be displayed on the screen.
Value Range	Max. 20 characters Note <ul style="list-style-type: none"> You can use Unicode characters for this setting.
Default Value	Empty string
Web User Interface Reference	Label Name

DSS_BUTTON_QUICK_DIALx

Parameter Name Example	DSS_BUTTON_QUICK_DIAL1, DSS_BUTTON_QUICK_DIAL2, ..., DSS_BUTTON_QUICK_DIAL200
Value Format	STRING
Description	x=1–200 Specifies a quick dial destination number to be used for the flexible key.
Value Range	Max. 32 digits(0–9, *, #)
Default Value	Empty string

5.3.33 Tone Settings**OUTSIDE_DIAL_TONE_FRQ**

Value Format	Comma-separated Integer
Description	Specifies the dual-tone frequencies, in hertz, of Second Dial Tone using max. 2 whole numbers separated by a comma.
Value Range	0, 200–2000(Hz) (0=No tone)
Default Value	420

OUTSIDE_DIAL_TONE_GAIN

Value Format	INTEGER
Description	Specifies the gain, in decibels, of Second Dial Tone
Value Range	-24–24 (dB)
Default Value	0

OUTSIDE_DIAL_TONE_RPT

Value Format	INTEGER
Description	Specifies whether Second Dial Tone is repeated.

Value Range	<ul style="list-style-type: none"> • 0: No Repeat • 1: Repeat
Default Value	0

OUTSIDE_DIAL_TONE_TIMING

Value Format	Comma-separated Integer
Description	Specifies the pattern, in milliseconds, of Second Dial Tone using Max. 10 whole numbers (off 1, on 1, off 2, on 2...) separated by commas.
Value Range	0–16000 (msec) (0=Continuous)
Default Value	60,0

CONFIRMATION_TONE5_FRQ

Value Format	Comma-separated Integer
Description	Specifies the confirmation tone 5 frequencies, in hertz, of confirmation tone 5 using Max. 2 whole numbers separated by a comma.
Value Range	200–2000 Hz (0: no tone)
Default Value	1000

CONFIRMATION_TONE5_GAIN

Value Format	INTEGER
Description	Specifies the gain, in decibels, of confirmation tone 5.
Value Range	-24–24 (dB)
Default Value	0

REORDER_TONE_ENABLE

Value Format	BOOLEAN
Description	Specifies whether to enable reorder tone.
Value Range	<ul style="list-style-type: none"> • Y: Enable • N: Disable
Default Value	Y

TONE_LEN_DISCONNECT

Value Format	INTEGER
Description	Specifies the duration, in seconds, that a disconnect tone will be heard when the other party ends a call and the unit is being used.
Value Range	1–15 (s)
Default Value	3

DIAL_TONE1_FRQ

Value Format	Comma-separated Integer
Description	Specifies the dual-tone frequencies, in hertz, of Dial Tone 1 using 2 whole numbers separated by a comma.
Value Range	0, 200–2000 (0: No tone)
Default Value	350,440
Web User Interface Reference	Tone Frequencies

DIAL_TONE1_GAIN

Value Format	INTEGER
Description	Specifies the gain, in decibels, of Dial Tone 1.
Value Range	-24–24 (dB)
Default Value	0

DIAL_TONE1_RPT

Value Format	INTEGER
Description	Specifies whether Dial Tone 1 is repeated.
Value Range	0–1 – 0: No Repeat – 1: Repeat
Default Value	0

DIAL_TONE1_TIMING

Value Format	Comma-separated Integer
Description	Specifies the pattern, in milliseconds, of Dial Tone 1 using up to 10 whole numbers (off 1, on 1, off 2, on 2...) separated by commas. Note <ul style="list-style-type: none">It is recommended that you set a value of 60 milliseconds or more for the first value (off 1).
Value Range	0–16000 (msec) (0=Continuous) Note <ul style="list-style-type: none">Avoid setting 1–50 for any of the values.
Default Value	60,0
Web User Interface Reference	Tone Timings

DIAL_TONE2_FRQ

Value Format	Comma-separated Integer
Description	Specifies the dual-tone frequencies, in hertz, of Dial Tone 2 using 2 whole numbers separated by a comma.

Value Range	0, 200–2000 (0: No tone)
Default Value	350,440

DIAL_TONE2_GAIN

Value Format	INTEGER
Description	Specifies the gain, in decibels, of Dial Tone 2.
Value Range	-24–24 (dB)
Default Value	0

DIAL_TONE2_RPT

Value Format	INTEGER
Description	Specifies whether Dial Tone 2 is repeated.
Value Range	0–1 – 0: No Repeat – 1: Repeat
Default Value	0

DIAL_TONE2_TIMING

Value Format	Comma-separated Integer
Description	Specifies the pattern, in milliseconds, of Dial Tone 2 using up to 10 whole numbers (off 1, on 1, off 2, on 2...) separated by commas. Note • It is recommended that you set a value of 60 milliseconds or more for the first value (off 1).
Value Range	0–16000 (0: Infinite time) Note • Avoid setting 1–50 for any of the values.
Default Value	60,0

DIAL_TONE4_FRQ

Value Format	Comma-separated Integer
Description	Specifies the dual-tone frequencies, in hertz, of Dial Tone 4 (stutter dial tones) to notify that a voice mail is waiting, using 2 whole numbers separated by a comma.
Value Range	0, 200–2000 (0: No tone)
Default Value	350,440
Web User Interface Reference	Tone Frequencies

DIAL_TONE4_GAIN

Value Format	INTEGER
---------------------	---------

5.3.33 Tone Settings

Description	Specifies the gain, in decibels, of Dial Tone 4 (stutter-type dial tone).
Value Range	-24–24 (dB)
Default Value	0

DIAL_TONE4_RPT

Value Format	INTEGER
Description	Specifies whether Dial Tone 4 (stutter-type dial tone) is repeated.
Value Range	0–1 – 0: No Repeat – 1: Repeat
Default Value	0

DIAL_TONE4_TIMING

Value Format	Comma-separated Integer
Description	Specifies the pattern, in milliseconds, of Dial Tone 4 (stutter dial tones) to notify that a voice mail is waiting, using up to 22 whole numbers (off 1, on 1, off 2, on 2...) separated by commas. Note <ul style="list-style-type: none">It is recommended that you set a value of 560 milliseconds or more for the first value (off 1).
Value Range	0–16000 (0: Continuous) Note <ul style="list-style-type: none">Avoid setting 1–50 for any of the values.
Default Value	560,100,0
Web User Interface Reference	Tone Timings

BUSY_TONE_FRQ

Value Format	Comma-separated Integer
Description	Specifies the dual-tone frequencies, in hertz, of busy tones using 2 whole numbers separated by a comma.
Value Range	0, 200–2000 (0: No tone)
Default Value	480,620
Web User Interface Reference	Tone Frequencies

BUSY_TONE_GAIN

Value Format	INTEGER
Description	Specifies the gain, in decibels, of the busy tone.
Value Range	-24–24 (dB)

Default Value	0
---------------	---

BUSY_TONE_RPT

Value Format	INTEGER
Description	Specifies whether the busy tone is repeated.
Value Range	0–1 – 0: No Repeat – 1: Repeat
Default Value	1

BUSY_TONE_TIMING

Value Format	Comma-separated Integer
Description	Specifies the pattern, in milliseconds, of busy tones using up to 10 whole numbers (off 1, on 1, off 2, on 2...) separated by commas. Note • It is recommended that you set a value of 60 milliseconds or more for the first value (off 1).
Value Range	0–16000 (0: Continuous) Note • Avoid setting 1–50 for any of the values.
Default Value	60,500,440
Web User Interface Reference	Tone Timings

REORDER_TONE_FRQ

Value Format	Comma-separated Integer
Description	Specifies the dual-tone frequencies, in hertz, of reorder tones using 2 whole numbers separated by a comma.
Value Range	0, 200–2000 (0: No tone)
Default Value	480,620
Web User Interface Reference	Tone Frequencies

REORDER_TONE_GAIN

Value Format	INTEGER
Description	Specifies the gain, in decibels, of the reorder tone.
Value Range	-24–24 (dB)
Default Value	0

REORDER_TONE_RPT

Value Format	INTEGER
--------------	---------

5.3.33 Tone Settings

Description	Specifies whether the reorder tone is repeated.
Value Range	0–1 – 0: No Repeat – 1: Repeat
Default Value	1

REORDER_TONE_TIMING

Value Format	Comma-separated Integer
Description	Specifies the pattern, in milliseconds, of reorder tones using up to 10 whole numbers (off 1, on 1, off 2, on 2...) separated by commas. Note <ul style="list-style-type: none">It is recommended that you set a value of 60 milliseconds or more for the first value (off 1).
Value Range	0–16000 (0: Continuous) Note <ul style="list-style-type: none">Avoid setting 1–50 for any of the values.
Default Value	60,250,190
Web User Interface Reference	Tone Timings

RINGBACK_TONE_FRQ

Value Format	Comma-separated Integer
Description	Specifies the dual-tone frequencies, in hertz, of ringback tones using 2 whole numbers separated by a comma.
Value Range	0, 200–2000 (0: No tone)
Default Value	440,480
Web User Interface Reference	Tone Frequencies

RINGBACK_TONE_GAIN

Value Format	INTEGER
Description	Specifies the gain, in decibels, of the ringback tone.
Value Range	-24–24 (dB)
Default Value	0

RINGBACK_TONE_RPT

Value Format	INTEGER
Description	Specifies whether the ringback tone is repeated.
Value Range	0–1 – 0: No Repeat – 1: Repeat

Default Value	1
---------------	---

RINGBACK_TONE_TIMING

Value Format	Comma-separated Integer
Description	Specifies the pattern, in milliseconds, of ringback tones using up to 10 whole numbers (off 1, on 1, off 2, on 2...) separated by commas. Note <ul style="list-style-type: none"> It is recommended that you set a value of 60 milliseconds or more for the first value (off 1).
Value Range	0–16000 (0: Continuous) Note <ul style="list-style-type: none"> Avoid setting 1–50 for any of the values.
Default Value	60,2000,3940
Web User Interface Reference	Tone Timings

HOLD_ALARM_FRQ

Value Format	Comma-separated Integer
Description	Specifies the dual-tone frequencies, in hertz, of the hold alarm using 2 whole numbers separated by a comma.
Value Range	0, 200–2000 (0: No tone)
Default Value	425

HOLD_ALARM_GAIN

Value Format	INTEGER
Description	Specifies the gain, in decibels, of the hold alarm.
Value Range	-24–24 (dB)
Default Value	0

CW_TONE1_FRQ

Value Format	Comma-separated Integer
Description	Specifies the dual-tone frequencies, in hertz, of call waiting tone 1 using 2 whole numbers separated by a comma.
Value Range	0, 200–2000 (0: No tone)
Default Value	425

CW_TONE1_GAIN

Value Format	INTEGER
Description	Specifies the gain, in decibels, of call waiting tone 1.
Value Range	-24–24 (dB)

5.3.33 Tone Settings

Default Value	0
---------------	---

HOLD_TONE_FRQ

Value Format	Comma-separated Integer
Description	Specifies the dual-tone frequencies, in hertz, of the hold tone using 2 whole numbers separated by a comma.
Value Range	0, 200–2000 (0: No tone)
Default Value	425

HOLD_TONE_GAIN

Value Format	INTEGER
Description	Specifies the gain, in decibels, of the hold tone.
Value Range	-24–24 (dB)
Default Value	0

BELL_CORE_PATTERN1_TIMING

Value Format	Comma-separated Integer
Description	Specifies the cadence, in milliseconds, of pattern ID 1, described in the LSSGR, GR-506-CORE, "Signaling for Analog Interfaces" section 14, using up to 8 whole numbers (on 1, off 1, on 2, off 2...) separated by commas.
Value Range	0–5000 (0: Continuous) Note <ul style="list-style-type: none">• Avoid setting 1–50 for any of the values.
Default Value	2000,4000

BELL_CORE_PATTERN2_TIMING

Value Format	Comma-separated Integer
Description	Specifies the cadence, in milliseconds, of pattern ID 2, described in the LSSGR, GR-506-CORE, "Signaling for Analog Interfaces" section 14, using up to 8 whole numbers (on 1, off 1, on 2, off 2...) separated by commas.
Value Range	0–5000 (0: Continuous) Note <ul style="list-style-type: none">• Avoid setting 1–50 for any of the values.
Default Value	800,400,800,4000

BELL_CORE_PATTERN3_TIMING

Value Format	Comma-separated Integer
--------------	-------------------------

Description	Specifies the cadence, in milliseconds, of pattern ID 3, described in the LSSGR, GR-506-CORE, "Signaling for Analog Interfaces" section 14, using up to 8 whole numbers (on 1, off 1, on 2, off 2...) separated by commas.
Value Range	0–5000 (0: Continuous) Note • Avoid setting 1–50 for any of the values.
Default Value	400,200,400,200,800,4000

BELL_CORE_PATTERN4_TIMING

Value Format	Comma-separated Integer
Description	Specifies the cadence, in milliseconds, of pattern ID 4, described in the LSSGR, GR-506-CORE, "Signaling for Analog Interfaces" section 14, using up to 8 whole numbers (on 1, off 1, on 2, off 2...) separated by commas.
Value Range	0–5000 (0: Continuous) Note • Avoid setting 1–50 for any of the values.
Default Value	300,200,1000,200,300,4000

BELL_CORE_PATTERN5_TIMING

Value Format	Comma-separated Integer
Description	Specifies the cadence, in milliseconds, of pattern ID 5, described in the LSSGR, GR-506-CORE, "Signaling for Analog Interfaces" section 14, using up to 8 whole numbers (on 1, off 1, on 2, off 2...) separated by commas.
Value Range	0–5000 (0: Continuous) Note • Avoid setting 1–50 for any of the values.
Default Value	500

KEY_PAD_TONE

Value Format	INTEGER
Description	Specifies whether a tone is heard in response to key presses.
Value Range	• 0: Off • 1: On
Default Value	1

5.3.34 Call Control Settings

DEFAULT_LINE_SELECT

Value Format	INTEGER
Description	Specifies the line used to make an outgoing call when no line is specified in the dialing operation.
Value Range	<ul style="list-style-type: none"> • 1: Line1 • 2: Line2 • 3: Line3 • 4: Line4 • 5: Line5 • 6: Line6 • 7: Line7 • 8: Line8 • 9: Line9 • 10: Line10 • 11: Line11 • 12: Line12 • 13: Line13 • 14: Line14 • 15: Line15 • 16: Line16
Default Value	1
Web User Interface Reference	Default Line for Outgoing

ANONYMOUS_CALL_ENABLE_n

Parameter Name Example	ANONYMOUS_CALL_ENABLE_1, ANONYMOUS_CALL_ENABLE_2, ..., ANONYMOUS_CALL_ENABLE_16
Value Format	BOOLEAN
Description	Specifies whether to make calls without transmitting the phone number to the called party.
Value Range	<ul style="list-style-type: none"> • Y: Enable anonymous call • N: Disable
Default Value	N
Web User Interface Reference	Enable Anonymous Call

BLOCK_ANONYMOUS_CALL_ENABLE_n

Parameter Name Example	BLOCK_ANONYMOUS_CALL_ENABLE_1, BLOCK_ANONYMOUS_CALL_ENABLE_2, ..., BLOCK_ANONYMOUS_CALL_ENABLE_16
Value Format	BOOLEAN
Description	Specifies whether to accept or reject the incoming call without the called party's phone number.
Value Range	<ul style="list-style-type: none"> • Y: Enable anonymous call block • N: Disable
Default Value	N
Web User Interface Reference	Enable Block Anonymous Call

HOTLINE_ENABLE

Value Format	BOOLEAN
Description	Specifies whether to enable or disable the Hot line feature.
Value Range	<ul style="list-style-type: none"> • Y: Enable • N: Disable
Default Value	N
Web User Interface Reference	Enable

HOTLINE_NUMBER

Value Format	STRING
Description	Specifies the Hot line number.
Value Range	Max. 32 characters
Default Value	Empty string
Web User Interface Reference	Hotline Number

HOTLINE_TIM

Value Format	INTEGER
Description	Specifies a time after off hook for Hot line.
Value Range	0–10 (s)
Default Value	2
Web User Interface Reference	Hotline Delay

DISPLAY_NAME_n

Parameter Name Example	DISPLAY_NAME_1, DISPLAY_NAME_2, ..., DISPLAY_NAME_16
Value Format	STRING
Description	Specifies the name to display as the caller on the other party's phone when you make a call.

Value Range	Max. 24 characters Note <ul style="list-style-type: none">You can use Unicode characters for this setting.
Default Value	Empty string
Web User Interface Reference	Display Name

VM_SUBSCRIBE_ENABLE

Value Format	BOOLEAN
Description	Specifies whether to send the SUBSCRIBE request to a voice mail server. Note <ul style="list-style-type: none">Your phone system must support voice mail.
Value Range	<ul style="list-style-type: none">Y (Send the SUBSCRIBE request)N (Do not send the SUBSCRIBE request)
Default Value	N
Web User Interface Reference	Send SUBSCRIBE to Voice Mail Server

VM_NUMBER_n

Parameter Name Example	VM_NUMBER_1, VM_NUMBER_2, ..., VM_NUMBER_16
Value Format	STRING
Description	Specifies the phone number used to access the voice mail server. Note <ul style="list-style-type: none">Your phone system must support voice mail.
Value Range	Max. 32 characters
Default Value	Empty string
Web User Interface Reference	Voice Mail Access Number

VM_SUBSCRIBE_SPECIFIC_n

Parameter Name Example	VM_SUBSCRIBE_SPECIFIC_1, VM_SUBSCRIBE_SPECIFIC_2, ..., VM_SUBSCRIBE_SPECIFIC_16
Value Format	STRING
Description	Specifies the defined name of a voice mail box.
Value Range	Max. 32 characters
Default Value	Empty string

DIAL_PLAN_n

Parameter Name Example	DIAL_PLAN_1, DIAL_PLAN_2, ..., DIAL_PLAN_16
Value Format	STRING

Description	Specifies a dial format, such as specific phone numbers, that control which numbers can be dialed or how to handle the call when making a call. For details, see 6.2 Dial Plan .
Value Range	Max. 1000 characters
Default Value	Empty string
Web User Interface Reference	Dial Plan (max 1000 columns)

DIAL_PLAN_NOT_MATCH_ENABLE_n

Parameter Name Example	DIAL_PLAN_NOT_MATCH_ENABLE_1, DIAL_PLAN_NOT_MATCH_ENABLE_2, ..., DIAL_PLAN_NOT_MATCH_ENABLE_16
Value Format	BOOLEAN
Description	Specifies whether to enable dial plan filtering so that a call is not made when the dialed number does not match any of the dial formats specified in "DIAL_PLAN_n".
Value Range	<ul style="list-style-type: none"> • Y (Enable dial plan filtering) • N (Disable dial plan filtering) <p>Note</p> <ul style="list-style-type: none"> • If set to "Y", the dialed number will not be sent to the line when the number dialed by the user does not match any of the dial formats specified in the dial plan. • If set to "N", the dialed number will be sent to the line, even if the number dialed by the user does not match any of the dial formats specified in the dial plan.
Default Value	N
Web User Interface Reference	Call Even If Dial Plan Does Not Match

MACRODIGIT_TIM

Value Format	INTEGER
Description	Specifies the length of time, in seconds, that the unit waits when a "T" or "t" has been entered in the dial plan.
Value Range	1–15
Default Value	5
Web User Interface Reference	Timer for Dial Plan

INTERNATIONAL_ACCESS_CODE

Value Format	STRING
Description	Specifies the number to be shown in the place of the first "+" symbol when the phone number for incoming international calls contains "+".

5.3.34 Call Control Settings

Value Range	Max. 8 characters (consisting of 0–9, *, and #) Note <ul style="list-style-type: none">No other characters are allowed.
Default Value	Empty string
Web User Interface Reference	International Call Prefix

COUNTRY_CALLING_CODE

Value Format	STRING
Description	Specifies the country/area calling code to be used for comparative purposes when dialing a number from the incoming call log that contains a "+" symbol.
Value Range	Max. 8 characters (consisting of 0–9)
Default Value	Empty string
Web User Interface Reference	Country Calling Code

NATIONAL_ACCESS_CODE

Value Format	STRING
Description	When dialing a number from the incoming call log that contains a "+" symbol and the country calling code matches, the country calling code is removed and the national access code is added.
Value Range	Max. 8 characters (consisting of 0–9, *, and #)
Default Value	Empty string
Web User Interface Reference	National Access Code

ADMIN_ABILITY_ENABLE

Value Format	BOOLEAN
Description	Specifies admin rights. Note If you attempt to configure System Settings without enabling admin rights, an error will occur and configuration will not be possible.
Value Range	<ul style="list-style-type: none">Y: AdminN: Non Admin
Default Value	Y
Web User Interface Reference	Enable Admin Ability

EMERGENCY_CALLx

Parameter Name Example	EMERGENCY_CALL1, EMERGENCY_CALL2, ..., EMERGENCY_CALL5
Value Format	STRING
Description	Specifies the emergency number. (Up to 5 emergency numbers)

Value Range	Max. 32 characters (except &, ", ', : , ; , < , >)
Default Value	Empty string
Web User Interface Reference	1–5

CALL_REJECTIONx

Parameter Name Example	CALL_REJECTION1, CALL_REJECTION2, ..., CALL_REJECTION30
Value Format	STRING
Description	Specifies the rejected number per line. (Up to 30 rejected numbers)
Value Range	Max. 32 characters (except &, ", ', : , ; , < , >)
Default Value	Empty string
Web User Interface Reference	1–30

CLICKTO_ENABLE_n

Parameter Name Example	CLICKTO_ENABLE_1, CLICKTO_ENABLE_2, ..., CLICKTO_ENABLE_16
Value Format	BOOLEAN
Description	Specifies whether to enable or disable Click to Dial/Answer/Hold functions.
Value Range	<ul style="list-style-type: none"> • Y: Enable • N: Disable
Default Value	N
Web User Interface Reference	Enable Click to Call

CALLPARK_NOTIFICATION_ENABLE_n

Parameter Name Example	CALLPARK_NOTIFICATION_ENABLE_1, CALLPARK_NOTIFICATION_ENABLE_2, ..., CALLPARK_NOTIFICATION_ENABLE_16
Value Format	BOOLEAN
Description	Specifies whether to respond to call park notifications from the server.
Value Range	<ul style="list-style-type: none"> • Y: Enable • N: Disable
Default Value	N
Web User Interface Reference	Enable Call Park Notification

SHARED_CALL_ENABLE_n

Parameter Name Example	SHARED_CALL_ENABLE_1, SHARED_CALL_ENABLE_2, ..., SHARED_CALL_ENABLE_16
Value Format	BOOLEAN

5.3.34 Call Control Settings

Description	Specifies whether to enable the Shared Call feature of the SIP server, which is used to share one line among the units. Note <ul style="list-style-type: none"> • Availability depends on your phone system.
Value Range	<ul style="list-style-type: none"> • Y (Enable shared call) • N (Disable shared call) Note <ul style="list-style-type: none"> • If set to "Y", the SIP server will control the line by using a shared-call signaling method. • If set to "N", the SIP server will control the line by using a standard signaling method.
Default Value	N
Web User Interface Reference	Enable Shared Call

SHARED_STOP_LINE_SEIZE

Value Format	BOOLEAN
Description	Specifies whether to stop seizing the Shared Call line at the unit side.
Value Range	<ul style="list-style-type: none"> • Y: Stop seizing the line • N: Seize the line
Default Value	N

FWD_DND_SYNCHRO_ENABLE_n

Parameter Name Example	FWD_DND_SYNCHRO_ENABLE_1, FWD_DND_SYNCHRO_ENABLE_2, ..., FWD_DND_SYNCHRO_ENABLE_16
Value Format	BOOLEAN
Description	Specifies whether to synchronize the Do Not Disturb and Call Forward settings, configured via the Web user interface or phone user interface, between the unit and the portal server that is provided by your phone system dealer/service provider. Note <ul style="list-style-type: none"> • Even if you specify "Y", this feature may not function properly if your phone system does not support it. Before you configure this setting, consult your phone system dealer/service provider.
Value Range	<ul style="list-style-type: none"> • Y (Enable Do Not Disturb/Call Forward synchronization) • N (Disable Do Not Disturb/Call Forward synchronization)
Default Value	N
Web User Interface Reference	Enable Key Synchronization (Enable Key Synchronisation)

FWD_SYNCHRO_FORCE_DISABLE_n

Parameter Name Example	FWD_SYNCHRO_FORCE_DISABLE_1, FWD_SYNCHRO_FORCE_DISABLE_2, ..., FWD_SYNCHRO_FORCE_DISABLE_16
Value Format	BOOLEAN
Description	Specifies whether to synchronize the Call Forward settings in "FWD_DND_SYNCHRO_ENABLE_n".
Value Range	<ul style="list-style-type: none"> • Y: Do not synchronize • N: Synchronize
Default Value	N

CONF_SERVER_HOLD_ENABLE

Value Format	BOOLEAN
Description	Specifies whether to hold the call when connecting an N-party conference.
Value Range	<ul style="list-style-type: none"> • Y: Hold the call • N: Do not hold the call
Default Value	N

MOH_SERVER_URI_n

Parameter Name Example	MOH_SERVER_URI_1, MOH_SERVER_URI_2, ..., MOH_SERVER_URI_16
Value Format	STRING
Description	Specifies MoH server URI for each line.
Value Range	Max. 384 characters
Default Value	Empty string
Web User Interface Reference	MoH Server URI

BS_EXECUTIVE_SETTING_ENABLE_n

Parameter Name Example	BS_EXECUTIVE_SETTING_ENABLE_1, BS_EXECUTIVE_SETTING_ENABLE_2, ..., BS_EXECUTIVE_SETTING_ENABLE_16
Value Format	BOOLEAN
Description	Specifies whether to enable or disable the Executive Call Filtering feature of the selected line.
Value Range	<ul style="list-style-type: none"> • Y: Enable • N: Disable
Default Value	N
Web User Interface Reference	Enable Executive Setting

BS_ASSISTANT_SETTING_ENABLE_n

Parameter Name Example	BS_ASSISTANT_SETTING_ENABLE_1, BS_ASSISTANT_SETTING_ENABLE_2, ..., BS_ASSISTANT_SETTING_ENABLE_16
Value Format	BOOLEAN
Description	Specifies whether to enable the Executive-Assistant Call Filtering feature and Executive-Assistant Divert feature of the selected line.
Value Range	<ul style="list-style-type: none"> • Y: Enable • N: Disable
Default Value	N
Web User Interface Reference	Enable Assistant Setting

FWD_DND_CONTROL_ENABLE

Value Format	BOOLEAN
Description	Specifies whether to enable the telephone for FWD/DND.
Value Range	<ul style="list-style-type: none"> • Y: Enable • N: Disable
Default Value	Y

FWD_DND_SYNCHRO_MODE

Value Format	INTEGER
Description	Specifies the mode of FWD/DND synchronizing with server.
Value Range	<ul style="list-style-type: none"> • 1: as feature event • 2: Panasonic original • 3: Entel
Default Value	1

HOLD_AND_CALL_ENABLE

Value Format	BOOLEAN
Description	Specifies whether making new call after holding the call or not.
Value Range	<ul style="list-style-type: none"> • Y: Enable (Hold and Call) • N: Disable (Hold)
Default Value	N

AUTO_CALL_HOLD

Value Format	BOOLEAN
Description	Specifies whether calls are disconnected or held when an other line is selected while having a conversation.

Value Range	<ul style="list-style-type: none"> • Y (Enable Auto Call Hold) • N (Disable Auto Call Hold)
Default Value	Y

SIP_RESPONSE_CODE_DND

Value Format	INTEGER
Description	Specifies the response code when a call is received in Do Not Disturb mode.
Value Range	400–699
Default Value	403

SIP_RESPONSE_CODE_CALL_REJECT

Value Format	INTEGER
Description	Specifies the response code when a call is rejected.
Value Range	400–699
Default Value	603

CW_ENABLE_n

Parameter Name Example	CW_ENABLE_1, CW_ENABLE_2, ..., CW_ENABLE_16
Value Format	BOOLEAN
Description	Specifies whether automatic call waiting is enabled.
Value Range	<ul style="list-style-type: none"> • Y (Enable Call Waiting) • N (Disable Call Waiting)
Default Value	Y
Web User Interface Reference	Enable Call Waiting

RETURN_VOL_SET_DEFAULT_ENABLE

Value Format	BOOLEAN
Description	Specifies whether the volume is returned to its default setting after each call.
Value Range	<ul style="list-style-type: none"> • Y (Volume returns to the default setting after each call) • N (Volume does not change after each call)
Default Value	N

CONFERENCE_SERVER_URI

Value Format	STRING
---------------------	--------

5.3.35 Video Communication Settings

Description	Specifies the URI for a conference server, which consists of "sip:", a user part, the "@" symbol, and a host part, for example, "sip:conference@example.com". Note <ul style="list-style-type: none">• Availability depends on your phone system.
Value Range	Max. 256 characters (except ", &, ', :, ;, <, >, and space)
Default Value	Empty string
Web User Interface Reference	Conference Server URI

RESOURCELIST_URI_n

Parameter Name Example	RESOURCELIST_URI_1, RESOURCELIST_URI_2, ..., RESOURCELIST_URI_16
Value Format	STRING
Description	Specifies the URI for the resource list, which consists of "sip:", a user part, the "@" symbol, and a host part.
Value Range	Max. 256 characters
Default Value	Empty string
Web User Interface Reference	Resource List URI

5.3.35 Video Communication Settings

DEFAULT_CALL_MODE

Value Format	INTEGER
Description	Specifies the default call type when you make a call by going off hook, etc.
Value Range	<ul style="list-style-type: none">• 0: Voice• 1: Video
Default Value	0
Web User Interface Reference	Default Call Mode

VIDEO_SCREEN_MODE

Value Format	INTEGER
Description	Specifies the mode for the video screen.
Value Range	<ul style="list-style-type: none">• 0: Normal• 1: Split
Default Value	0
Web User Interface Reference	Screen Mode

VIDEO_SEND_IMAGE_ENABLE

Value Format	BOOLEAN
---------------------	---------

Description	Specifies whether the video is automatically sent when you start a video call.
Value Range	<ul style="list-style-type: none"> • Y: Enable • N: Disable
Default Value	Y
Web User Interface Reference	Send Image at Start

VIDEO_BIT_RATE

Value Format	INTEGER
Description	Specifies the bit rate for the video when you make a video call.
Value Range	<ul style="list-style-type: none"> • 0: 128 • 1: 256 • 2: 384 • 3: 512 • 4: 768 • 5: 1024 • 6: 2048
Default Value	6
Web User Interface Reference	Bit Rate

VIDEO_BIT_RATE_USE

Value Format	INTEGER
Description	Selects whether the specified bit rate is treated as the maximum bit rate or a fixed bit rate.
Value Range	<ul style="list-style-type: none"> • 0: Maximum • 1: Fixed
Default Value	0
Web User Interface Reference	Bit Rate Use

VIDEO_FRAME_RATE

Value Format	INTEGER
Description	Specifies the frame rate for the video when you make a video call.
Value Range	<ul style="list-style-type: none"> • 15: 15 • 30: 30
Default Value	30
Web User Interface Reference	Frame Rate

VIDEO_IMAGE_SIZE

Value Format	INTEGER
---------------------	---------

Description	Specifies the size for video images when you make a video call.
Value Range	<ul style="list-style-type: none"> • 0: QCIF • 1: QVGA • 2: CIF • 3: HVGAW • 4: VGA
Default Value	3
Web User Interface Reference	Image Size

H264_PAYLOAD

Value Format	INTEGER
Description	Specifies the payload size for H.264.
Value Range	96–125
Default Value	102

5.3.36 Network Camera Settings

NWCAMERA_DISPLAY_NAME_x

Parameter Name Example	NWCAMERA_DISPLAY_NAME1, NWCAMERA_DISPLAY_NAME2, ..., NWCAMERA_DISPLAY_NAME16
Value Format	STRING
Description	x=1–16 Specifies the name of the Network Camera to be displayed in the Network Camera viewer.
Value Range	Max. 20 characters
Default Value	Empty string

NWCAMERA_ADDR_x

Parameter Name Example	NWCAMERA_ADDR1, NWCAMERA_ADDR2, ..., NWCAMERA_ADDR16
Value Format	STRING
Description	x=1–16 Specifies the address of the Network Camera.
Value Range	Max. 256 characters
Default Value	Empty string

NWCAMERA_PORT_x

Parameter Name Example	NWCAMERA_PORT1, NWCAMERA_PORT2, ..., NWCAMERA_PORT16
Value Format	INTEGER

Description	x=1–16 Specifies the port of the Network Camera.
Value Range	1–65535
Default Value	80

NWCAMERA_USER_IDx

Parameter Name Example	NWCAMERA_USER_ID1, NWCAMERA_USER_ID2, ..., NWCAMERA_USER_ID16
Value Format	STRING
Description	x=1–16 Specifies the user ID to connect to the Network Camera.
Value Range	Max. 32 characters
Default Value	Empty string

NWCAMERA_PASSx

Parameter Name Example	NWCAMERA_PASS1, NWCAMERA_PASS2, ..., NWCAMERA_PASS16
Value Format	STRING
Description	x=1–16 Specifies the password to connect to the Network Camera.
Value Range	Max. 32 characters
Default Value	Empty string

NWCAMERA_PAGING_PHONE_NAMEx

Parameter Name Example	NWCAMERA_PAGING_PHONE_NAME1, NWCAMERA_PAGING_PHONE_NAME2, ..., NWCAMERA_PAGING_PHONE_NAME16
Value Format	STRING
Description	x=1–16 Specifies the name of the phone to use for Network Camera paging.
Value Range	Max. 24 characters
Default Value	Empty string

NWCAMERA_PAGING_PHONE_NUMBERx

Parameter Name Example	NWCAMERA_PAGING_PHONE_NUMBER1, NWCAMERA_PAGING_PHONE_NUMBER2, ..., NWCAMERA_PAGING_PHONE_NUMBER16
Value Format	STRING
Description	x=1–16 Specifies the phone number to use for Network Camera paging.
Value Range	Max. 24 characters

Default Value	Empty string
---------------	--------------

NWCAMERA_LINK_PHONE_m_NAME_x

Parameter Name Example	NWCAMERA_LINK_PHONE1_NAME1, NWCAMERA_LINK_PHONE1_NAME2, ..., NWCAMERA_LINK_PHONE5_NAME16
Value Format	STRING
Description	m=1–5, x=1–16 Specifies the phone name to use for Network Camera phone number linkage.
Value Range	Max. 24 characters
Default Value	Empty string

NWCAMERA_LINK_PHONE_m_NUMBER_x

Parameter Name Example	NWCAMERA_LINK_PHONE1_NUMBER1, NWCAMERA_LINK_PHONE1_NUMBER2, ..., NWCAMERA_LINK_PHONE5_NUMBER16
Value Format	STRING
Description	m=1–5, x=1–16 Specifies the phone number to use for Network Camera phone number linkage.
Value Range	Max. 32 characters
Default Value	Empty string

NWCAMERA_STREAM_x

Parameter Name Example	NWCAMERA_STREAM1, NWCAMERA_STREAM2, ..., NWCAMERA_STREAM16
Value Format	INTEGER
Description	x=1–16 Specifies the stream of the Network Camera image.
Value Range	<ul style="list-style-type: none"> • 1: Stream1 • 2: Stream2
Default Value	1

NWCAMERA_ALARM_NOTIFICATION

Value Format	INTEGER
Description	Specifies the mode for Network Camera alarm notifications.
Value Range	<ul style="list-style-type: none"> • 0: Off • 1: Pop-up
Default Value	0

NWCAMERA_ALARM_DISARM_TIME

Value Format	INTEGER
Description	Specifies the time, in seconds, for the alarm interval.
Value Range	2–10
Default Value	2

NWCAMERA_ALARM_PORT

Value Format	INTEGER
Description	Specifies the local port number for Network Camera alarms.
Value Range	1024–65535
Default Value	1818

5.3.37 Communication Camera Settings**COMM_CAMERA_NUMBERx**

Parameter Name Example	COMM_CAMERA_NUMBER1, COMM_CAMERA_NUMBER2, ..., COMM_CAMERA_NUMBER16
Value Format	STRING
Description	x=1–16 Specifies the phone number of each Communication Camera.
Value Range	Max. 32 characters
Default Value	Empty string
Web User Interface Reference	Phone Number

COMM_CAMERA_NAMEx

Parameter Name Example	COMM_CAMERA_NAME1, COMM_CAMERA_NAME2, ..., COMM_CAMERA_NAME16
Value Format	STRING
Description	x=1–16 Specifies the name of each Communication Camera.
Value Range	Max. 24 characters
Default Value	Empty string
Web User Interface Reference	Name

COMM_CAMERA_RINGTONE_SETTINGx

Parameter Name Example	COMM_CAMERA_RINGTONE_SETTING1, COMM_CAMERA_RINGTONE_SETTING2, ..., COMM_CAMERA_RINGTONE_SETTING16
Value Format	INTEGER
Description	x=1–16 Specifies the ringtone of each Communication Camera.

Value Range	1–32 (10: doorbell)
Default Value	10
Web User Interface Reference	Ringtone [1 - 32]

DTMF_CONTROL_UP_CAMERA x

Parameter Name Example	DTMF_CONTROL_UP_CAMERA1, DTMF_CONTROL_UP_CAMERA2, ..., DTMF_CONTROL_UP_CAMERA16
Value Format	STRING
Description	$x=1-16$ Specifies the DTMF value for tilting the camera up for each Communication Camera.
Value Range	Max. 8 digits (0–9, *, #)
Default Value	2

DTMF_CONTROL_DOWN_CAMERA x

Parameter Name Example	DTMF_CONTROL_DOWN_CAMERA1, DTMF_CONTROL_DOWN_CAMERA2, ..., DTMF_CONTROL_DOWN_CAMERA16
Value Format	STRING
Description	$x=1-16$ Specifies the DTMF value for tilting the camera down for each Communication Camera.
Value Range	Max. 8 digits (0–9, *, #)
Default Value	8

DTMF_CONTROL_LEFT_CAMERA x

Parameter Name Example	DTMF_CONTROL_LEFT_CAMERA1, DTMF_CONTROL_LEFT_CAMERA2, ..., DTMF_CONTROL_LEFT_CAMERA16
Value Format	STRING
Description	$x=1-16$ Specifies the DTMF value for panning the camera left for each Communication Camera.
Value Range	Max. 8 digits (0–9, *, #)
Default Value	4

DTMF_CONTROL_RIGHT_CAMERA x

Parameter Name Example	DTMF_CONTROL_RIGHT_CAMERA1, DTMF_CONTROL_RIGHT_CAMERA2, ..., DTMF_CONTROL_RIGHT_CAMERA16
Value Format	STRING
Description	$x=1-16$ Specifies the DTMF value for panning the camera right for each Communication Camera.

Value Range	Max. 8 digits (0–9, *, #)
Default Value	6

DTMF_CONTROL_OPEN_CAMERAx

Parameter Name Example	DTMF_CONTROL_OPEN_CAMERA1, DTMF_CONTROL_OPEN_CAMERA2, ..., DTMF_CONTROL_OPEN_CAMERA16
Value Format	STRING
Description	x=1–16 Specifies the DTMF value for opening the door near the camera for each Communication Camera.
Value Range	Max. 8 digits (0–9, *, #)
Default Value	5

DTMF_CONTROL_ZOOMUP_CAMERAx

Parameter Name Example	DTMF_CONTROL_ZOOMUP_CAMERA1, DTMF_CONTROL_ZOOMUP_CAMERA2, ..., DTMF_CONTROL_ZOOMUP_CAMERA16
Value Format	STRING
Description	x=1–16 Specifies the DTMF value for zooming in for each Communication Camera.
Value Range	Max. 8 digits (0–9, *, #)
Default Value	9

DTMF_CONTROL_ZOOMDOWN_CAMERAx

Parameter Name Example	DTMF_CONTROL_ZOOMDOWN_CAMERA1, DTMF_CONTROL_ZOOMDOWN_CAMERA2, ..., DTMF_CONTROL_ZOOMDOWN_CAMERA16
Value Format	STRING
Description	x=1–16 Specifies the DTMF value for zooming out for each Communication Camera.
Value Range	Max. 8 digits (0–9, *, #)
Default Value	7

DTMF_CONTROL_VOICE_CAMERAx

Parameter Name Example	DTMF_CONTROL_VOICE_CAMERA1, DTMF_CONTROL_VOICE_CAMERA2, ..., DTMF_CONTROL_VOICE_CAMERA16
Value Format	STRING
Description	x=1–16 Specifies the DTMF value for talking with the camera for each Communication Camera.

Value Range	Max. 8 digits (0–9, *, #)
Default Value	*

5.3.38 Logging Settings

SYSLOG_ADDR

Value Format	STRING
Description	Specifies the IP address or FQDN of Syslog server.
Value Range	Max. 256 characters
Default Value	Empty string

SYSLOG_PORT

Value Format	INTEGER
Description	Specifies the port of Syslog server.
Value Range	1–65535
Default Value	514

LOGGING_LEVEL_DNS

Value Format	INTEGER
Description	Specifies the log level of DNS.
Value Range	0–6
Default Value	0

LOGGING_LEVEL_NW1

Value Format	INTEGER
Description	Specifies the log level of SNTP.
Value Range	0–6
Default Value	0

LOGGING_LEVEL_FILE

Value Format	INTEGER
Description	Specifies the log level of FILE downloading.
Value Range	0–6
Default Value	6

LOGGING_LEVEL_SIP

Value Format	INTEGER
Description	Specifies the log level of SIP.
Value Range	0–6

Default Value	0
---------------	---

LOGGING_LEVEL_TR069

Value Format	INTEGER
Description	Specifies the log level of TR-069.
Value Range	0–6
Default Value	0

LOGGING_LEVEL_STUN

Value Format	INTEGER
Description	Specifies the log level of STUN.
Value Range	0–6
Default Value	0

LOGGING_LEVEL_NW2

Value Format	INTEGER
Description	Specifies the log level of Xsi, XML, XMPP, LDAP.
Value Range	0–6
Default Value	0

LOGGING_LEVEL_CFGPARSE

Value Format	INTEGER
Description	Specifies the log level of configuration parse.
Value Range	0–6
Default Value	0

5.3.38 Logging Settings

Section 6

Useful Telephone Functions

This section explains phone number settings, dial plan settings, the phonebook import/export function, the Broadsoft XSI function, the BroadCloud (Presence) function and Pairing (Parallel Mode).

6.1 Phonebook Import and Export

This section explains how to import and export phonebook data. Phonebook data of the unit includes names and phone numbers.

Phonebook data on the unit can be exported, edited with editor tools, and imported again. In addition, phonebook data created with other software can be imported into the unit.

You can use the phonebook import and export functions as follows.

- A. Phonebook data
- B. Microsoft Excel
- C. Microsoft Outlook

Editing Phonebook Data on a PC

The phonebook data stored on the unit can be edited using a program such as Microsoft Excel® spreadsheet software. For details about the operation, see **6.1.2 Editing with Microsoft Excel**.

You can export the phonebook data to the PC, edit the exported file using appropriate software, and then import it into the unit.

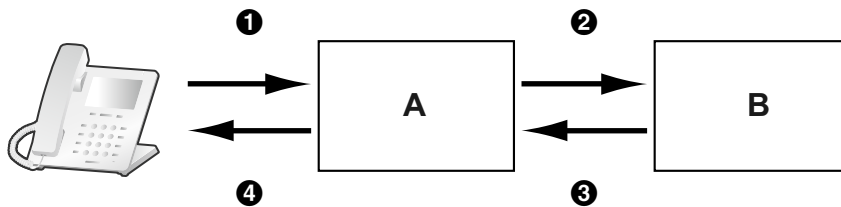

Importing Address Book Data from a PC

You can import address book data stored in programs, such as Microsoft Outlook® messaging and collaboration client, into the unit.

First, export address book data from the e-mail software to a program such as Microsoft Excel, edit it as necessary, and then import the exported data into the unit.

For details about the operation, see **6.1.3 Exporting Data from Microsoft Outlook**.

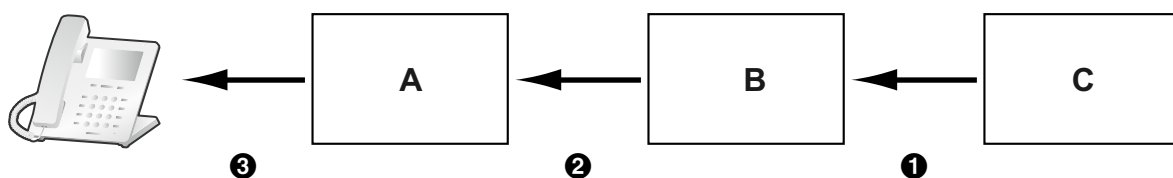

Backing up Phonebook Data

You can export the phonebook data from the unit to a PC and keep the file as a backup in case of data loss or for use when exchanging the unit.

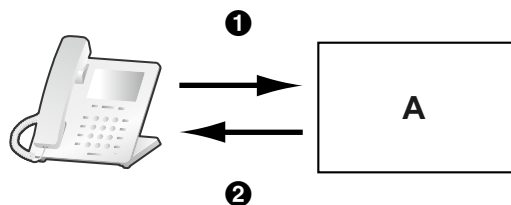

Importing the Same Phonebook Data to other Units

You can export the phonebook data created on a unit to a PC, and then import it into other units.

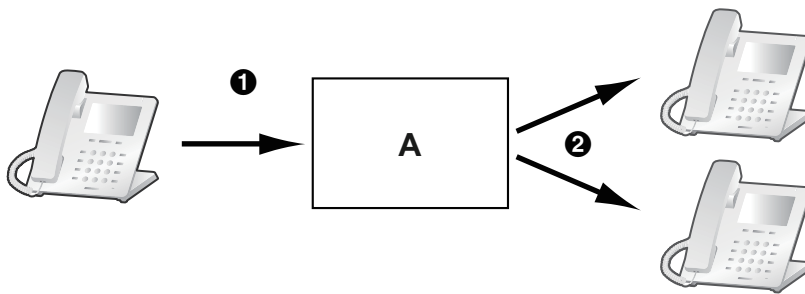

You can also import phonebook data created on a PC to other units.

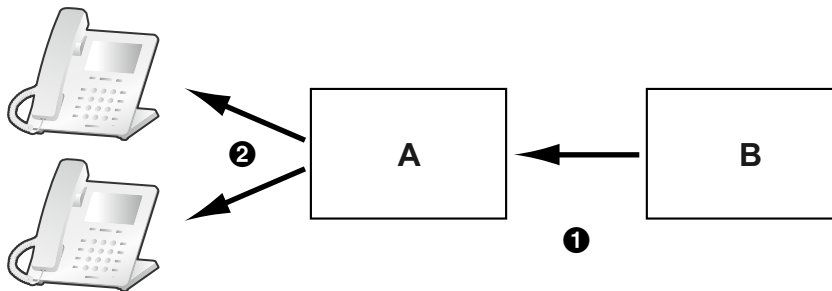

Import/Export File Format

The file format used for importing and exporting the phonebook data is "TSV". When importing or exporting using Microsoft Excel, "CSV (Comma-separated Value)" is generally used as the file format.

A phonebook entry in the unit has 9 fields. An entry in the phonebook data is represented in text as "record ID <TAB> name <TAB> reserved <TAB> phone number <TAB> phone number <TAB> phone number <TAB> phone number <TAB> reserved <line break>".

The text data can be edited using any text editing software that supports UTF-16 encoding with a BOM and little endian byte ordering. When you save the text file, it must be saved using the same format, or the text might become garbled.

Phonebook Data in Text Format

1	2	3	4	5	6	7	8	9	10	11	12	13	14	15	16	17
1		Aaron MacDowel				501		1234001								
2		Barbara Nicolls				502		1234002								
3		Carl O'Brien				503		1234003								
4		Dorothy Parker						1234004								
...									
...									

- 1 Record ID (Unique ID: 1–500)
- 2 Tab
- 3 Name (up to 24 characters)
- 4 Tab
- 5 Reserved (up to 24 characters)
- 6 Tab
- 7 Phone number (up to 32 digits)
- 8 Tab
- 9 Phone number (up to 32 digits)
- 10 Tab
- 11 Phone number (up to 32 digits)
- 12 Tab
- 13 Phone number (up to 32 digits)
- 14 Tab
- 15 Phone number (up to 32 digits)
- 16 Tab
- 17 Reserved

6.1.1 Import/Export Operation

The following procedures explain how to import phonebook data to units, and how to export phonebook data from units to a PC through the Web user interface.

For details about the settings, see **4.6.6 Import Phonebook** or **4.6.7 Export Phonebook**.

To import phonebook data

1. Click the **[Telephone]** tab, and then click **[Import Phonebook]**.
2. In **[File Name]**, enter the full path to the file that you want to import, or click **Browse** to select the phonebook data file that you want to import.
3. Click **[Import]**.

To export the phonebook data

1. Click the **[Telephone]** tab, and then click **[Export Phonebook]**.
2. Click **[Export]**.
3. On the "Now Processing File Data" screen, click the text "HERE" in the displayed message, or wait until **File Download** window appears.

Note

- Depending on the security settings of your Web browser, pop-up menus might be blocked. If the file cannot be exported successfully, try the export operation again or change the security settings of your Web browser.

4. Click **Save** on **File Download** window.
5. On the **Save As** window, select a folder to save the exported phonebook data to, enter the file name in **File name**, select **TSV File** for **Save as type**, and click **Save**.
If the file is downloaded successfully, the **Download complete** window appears.
6. Click **Close**.
7. To exit the operation, click the text "HERE" in the displayed message.
The **[Export Phonebook]** screen returns.

Note

- Make sure that the import source or unit is in standby mode.
- The import source or unit must be specified at the time of import/export. The imported data is added to the existing phonebook data.
 - If the existing phonebook data has an entry with the same record ID as an imported entry, the entry is overwritten with the imported entry.
 - If the existing phonebook data has an entry with no record ID, it will be left in the phonebook.
 - If the imported phonebook data has an entry with no record ID, the imported entry is added as a new entry unless an existing entry with the same name and phone number is found.
 Phonebook entries that are added via the unit are not assigned record IDs. Therefore, it is recommended to export phonebook data from the unit, assign record IDs manually and then re-import them. Doing so can help manage phonebook data.
- The phonebook for a unit has the following limitations:
 - A maximum of 500 phonebook entries can be stored in the unit. If the unit already has phonebook data, it accepts up to the 500th entry, including the existing entries.
 - The name can contain up to 24 characters.
 - The phone number can contain up to 32 digits.
 - Phonebook entries exceeding the characters or digits limits cannot be imported properly.
- If the export is interrupted by an operation on the unit, only the data that has been successfully exported before the interruption is exported to a file.

6.1.2 Editing with Microsoft Excel

You can edit exported phonebook data on a PC with software such as Microsoft Excel. You can then import the phonebook data into units.

To open the phonebook data on a PC

1. Open Microsoft Excel.
2. Click **Office Button**, and then **Open**.

Note

- Make sure to open a TSV file in this procedure. If you change the extension of a TSV file to ".csv", the file will open by simply double-clicking it. However, the character encoding of the file might not be recognized properly, resulting in garbled characters, or the phone numbers might be recognized as numbers, resulting in data alteration.

6.1.2 Editing with Microsoft Excel

3. Select **All Files** for the file type, select the exported phonebook data file, and click **Open**.

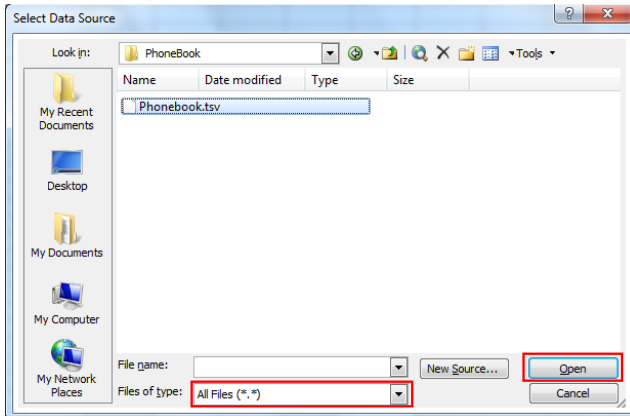

4. On the **Text Import Wizard - Step 1 of 3** window, click **Next**.

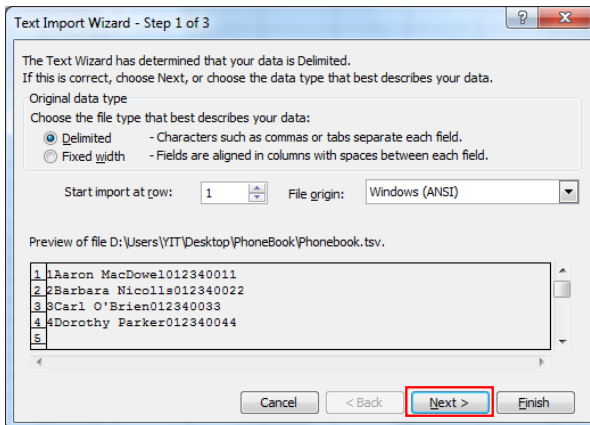

Note

- Regardless of what is selected for **File origin**, the file will be processed normally if the format is appropriate.

5. On the **Text Import Wizard - Step 2 of 3** window, select **Tab** for **Delimiters**, and then click **Next**.

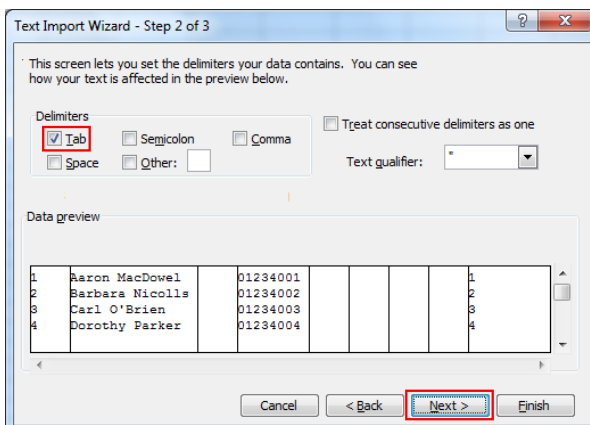

- On the **Text Import Wizard - Step 3 of 3** window, select all columns in **Data preview**, select **Text** in **Column data format**, and then click **Finish**.
The TSV file will be opened.

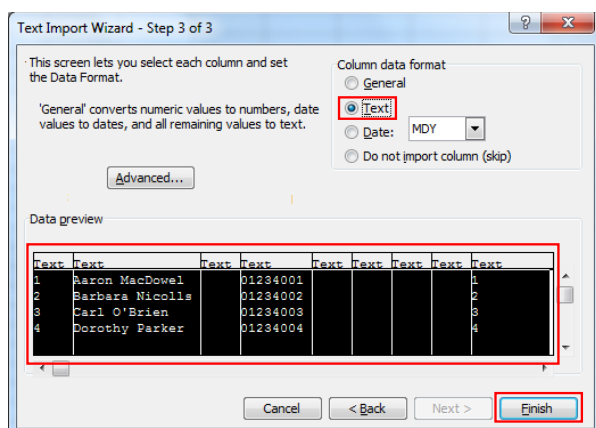

Note

- Phone numbers must be treated as text strings. Otherwise, a "0" at the beginning of a phone number might disappear when exported.

To save the phonebook data for importing to the unit

- After editing the phonebook entries, click **Office Button**, and then **Save As**.
- Enter a file name in **File name**, and select **Unicode Text** in **Save as type**.
The file will be saved in UTF-16 little endian with a BOM. Fields will be separated by tabs.
- Click **Save**.
A message warning you about file compatibility will be displayed.
- Click **Yes**.
The file will be saved as a Unicode text file, with the fields separated by tabs.

Note

- The procedure may vary depending on the software version of Microsoft Excel. Therefore, files exported and imported between the unit and Microsoft Excel are not always compatible with each other.

6.1.3 Exporting Data from Microsoft Outlook

You can export address book data stored in programs such as Microsoft Outlook, and then edit the exported data with a program such as Microsoft Excel in order to import it to the unit.

To export the Microsoft Outlook address book data

- In Microsoft Outlook, click **File**, and then click **Import and Export**.
- Select **Export to a file**, and click **Next**.
- Select **Tab Separated Values (Windows)**, and click **Next**.
- Select **Contacts**, and click **Next**.
- Click **Browse**, select a folder, and then enter the file name to export the data to.
- Click **OK**.
- On the **Export to a File** window, click **Next**.

8. Click **Map Custom Fields**.
9. Clear all items in the **To** list by clicking **Clear Map**. Then, drag only **Last Name** and **Business Phone** from the **From** list to the **To** list, and click **OK**.
10. On the **Export to a File** window, click **Finish**.
The data will be exported.

Note

- You can export data from Microsoft Outlook Express by using a similar procedure. It is also possible to export data from other applications that are compatible with Microsoft Excel.
- You can open the exported file in Microsoft Excel, and then import it to the unit. For details, see **6.1.2 Editing with Microsoft Excel**.
- First and middle names are not exported using this procedure. You can export all necessary items and edit the entry before importing them to the unit.
- In the file exported from Microsoft Outlook, fields are separated by tabs and encoded using the default character encoding for your operating system.

6.2 Dial Plan

The dial plan settings control how numbers dialed by the user are transmitted over the network. Dial plan settings can be configured on a per-line basis. These settings can be programmed either through the Web user interface (→ see **4.6.2.2 Dial Plan**) or by configuration file programming (→ see **5.3.34 Call Control Settings**).

6.2.1 Dial Plan Settings

To set Dial Plan

1. In the Web user interface, click the **[Telephone]** tab, and then click **[Call Control [Line 1]–[Line x]]**.
2. In **[Dial Plan]**, enter the desired dial format.
The dial plan settings can be configured for each line separately.
For details about available characters for the dial format, see **Available Values for the Dial Plan Field** in this section.
3. Select **[Yes]** or **[No]** for **[Call Even If Dial Plan Does Not Match]**.
 - If you select **[Yes]**, the call will be made even if the user dials a phone number that does not match the dial format in **[Dial Plan]**.
 - If you select **[No]**, the call will be made only if the user dials a phone number that matches the dial format in **[Dial Plan]**.

Note

- For details about configuring these settings by configuration file programming, see "DIAL_PLAN_n" and "DIAL_PLAN_NOT_MATCH_ENABLE_n" in **5.3.34 Call Control Settings**.

Available Values for the Dial Plan Field

The following table explains which characters you can use in the dial format, and what the characters mean.

Element	Available Value	Description
String	0–9, [, -,], <, :, >, *, #, !, S, s, T, t, X, x, ., , +	You can enter dial plan descriptions using a combination of the characters listed as available values.

Element	Available Value	Description
Digit	0–9, *, #, +	Example: "123" If the dialed phone number is "123", the call is made immediately.
Wildcard	X, x	Example: "12xxxxx" If the dialed phone number is "12" followed by any 5-digit number, the call is made immediately.
Range	[]	Example: "[123]" If the dialed phone number is either one of "1", "2", or "3", the call is made immediately.
Subrange	-	Example: "[1-5]" If the dialed phone number is "1", "2", "3", "4", or "5", the call is made immediately. <ul style="list-style-type: none">A subrange is only valid for single-digit numbers. For example, "[4-9]" is valid, but "[12-21]" is invalid.
Repeat	.	Example: "1." If the dialed phone number is "1" followed by zero or more "1"s (e.g., "11", "111"), the call is made.
Substitution	<(before):(after)>	Example: "<101:9999>" If the dialed phone number is "101", "101" is replaced by "9999", and then the call is made immediately.
Timer	S, s (second)	Example: "1x.S2" If the dialed phone number begins with "1", the call is made after a lapse of 2 seconds. <ul style="list-style-type: none">The number (0–9) followed by "S" or "s" shows the duration in seconds until the call is made.
Macro Timer	T, t	Example: "1x.T" If the dialed phone number begins with "1", the call is made after a lapse of "T" seconds. <ul style="list-style-type: none">The value of "T" or "t" can be configured through the Web user interface (→ see [Timer for Dial Plan] in 4.6.1.1 Call Control).
Reject	!	Example: "123xxx!" If the dialed phone number is "123" followed by 3 digits, the call is not made.
Alternation		Example: "1xxxx 2xxx" If the dialed phone number is "1" followed by 4 digits, or "2" followed by 3 digits, the call is made immediately. You can use this element to specify multiple numbers.
Comma	,	Example: "9,xxxxxxxxxxx.T" If 9 is dialed, the second dial tone is heard, and then 11 digits are dialed, the call is made after waiting "T" seconds. * The dialing will include the initially dialed "9".

Note

- You can enter up to 1000 characters in **[Dial Plan]**.

6.2.1 Dial Plan Settings

- You can assign up to 100 dial plans separated by "|" in **[Dial Plan]**.
- You can assign up to 32 digits per dial plan in **[Dial Plan]**.
- You can assign up to 10 substitutions in **[Dial Plan]**.
- After the user completes dialing, the unit immediately sends all the dialed digits if **[Call Even If Dial Plan Does Not Match]** is set to **[Yes]** in the Web user interface or if "DIAL_PLAN_NOT_MATCH_ENABLE_n" is set to "N" in a configuration file. The unit recognizes the end of dialing as follows:
 - The inter-digit timer expires (→ see **[Inter-digit Timeout]** in **4.6.1.1 Call Control** in the Web user interface or "INTDIGIT_TIM" in **5.3.30 Telephone Settings** in the configuration file).
 - The user presses **[ENTER]** or the # key.
 - The call is initiated after going off-hook (pre-dial).

Dial Plan Example

The following example shows dial plans containing character sequences separated by "|".
Example: "[2346789]11|01[2-9]x.[[2-9]xxxxxxxxx"

Complete Match:

Example: "[2346789]11|01[2-9]x.[[2-9]xxxxxxxxx"

- If the dialed phone number is "211", "911" and so on, the call is made immediately.

Example: "[2346789]11|01[2-9]x.[[2-9]xxxxxxxxx"

- If the dialed phone number is "2123456789", "5987654321" and so on, the call is made immediately.

Partial Match (when the dial plan contains "."):

Example: "[2346789]11|01[2-9]x.[[2-9]xxxxxxxxx"

- If the dialed phone number is "01254", "012556" and so on, the call is made after the inter-digit timer expires.

Partial Match (when the dial plan does not contain "."):

Example: "[2346789]11|01[2-9]x.[[2-9]xxxxxxxxx"

- If the dialed phone number is "21", "91" and so on when **[Call Even If Dial Plan Does Not Match]** is set to **[Yes]**, the call is made after the inter-digit timer expires.
- If the dialed phone number is "21", "91" and so on when **[Call Even If Dial Plan Does Not Match]** is set to **[No]**, the call is denied after the inter-digit timer expires.

Example: "[2346789]11|01[2-9]x.[[2-9]xxxxxxxxx"

- If the dialed phone number is "21234567", "598765432" and so on when **[Call Even If Dial Plan Does Not Match]** is set to **[Yes]**, the call is made after the inter-digit timer expires.
- If the dialed phone number is "21234567", "598765432" and so on when **[Call Even If Dial Plan Does Not Match]** is set to **[No]**, the call is denied after the inter-digit timer expires.

No Match:

Example: "[2346789]11|01[2-9]x.[[2-9]xxxxxxxxx"

- If the dialed phone number is "0011", "1011" and so on when **[Call Even If Dial Plan Does Not Match]** is set to **[Yes]**, the call is made after the inter-digit timer expires.
- If the dialed phone number is "0011", "1011" and so on when **[Call Even If Dial Plan Does Not Match]** is set to **[No]**, the call is denied.

6.3 Flexible Keys

You can customize the flexible keys on the unit. They can then be used to make or receive outside calls or as feature buttons (function keys). These settings can be programmed either through the Web user interface (→ see **4.6.4 Flexible Key Settings (No. 1–24)** and **4.6.9 DSS Console**) or by configuration file programming (→ see **5.3.31 Flexible Key Settings** and **5.3.32 DSS Key Settings**).

The following types of flexible keys are available:

Button	Description	Lamp Indication
One Touch Dial	Used to dial a previously set phone number with one touch.	-
BLF (Busy Lamp Field)	<p>Used to show the current status of another extension, call the extension and transfer calls to it.</p> <p>Note</p> <ul style="list-style-type: none"> It may be necessary to specify the Resource List URI to use this feature, depending on your phone system (→ see [Resource List URI] in 4.6.2.1 Call Features in the Web user interface or "RESOURCELIST_URI_n" in 5.3.34 Call Control Settings in the configuration file). Specify the number assigned to a BLF for performing call pickup (→ see [Directed Call Pickup] in 4.6.1.1 Call Control in the Web user interface or "NUM_PLAN_PICKUP_DIRECT" in 5.3.30 Telephone Settings in the configuration file). 	<p>Off: The BLF extension is idle.</p> <p>Red on: A corresponding BLF extension is using the line.</p> <p>Flashing red rapidly: The BLF extension is receiving an incoming call.</p>
Line	Used to seize a line in order to make or receive a call. The LED of the function key indicates the status of the line.	<p>Off: The line is idle.</p> <p>Blue on: The line is on a call.</p> <p>Flashing blue slowly: A call is on hold.</p> <p>Flashing blue rapidly: A call (including Hold Recall) is being received to the line (or a shared line).</p> <p>Red on: A shared line is in use or a call is on private hold at another unit.</p> <p>Flashing blue slowly: A shared line is on hold at another unit.</p>

6.3 Flexible Keys

Button	Description	Lamp Indication
ACD ¹	<p>Used to log in or log out of a group when ACD (Automatic Call Distribution) is enabled.</p> <p>Note</p> <ul style="list-style-type: none"> It is necessary to set the ACD feature to enable (→ see [Enable ACD] in 4.3.10 ACD Settings [Line1]–[Line16] in the Web user interface or "ACD_ENABLE_n" in 5.3.14 Call Center Settings in the configuration file). 	<p>Off: Logged in Red on: Logged out</p>
Wrap Up ¹	<p>The Wrap Up button alternates the setting of Wrap Up mode, Not Ready mode or Ready mode for incoming calls. In Wrap Up mode/Not Ready mode for incoming calls, incoming calls will not be received through the ACD (Automatic Call Distribution) group.</p> <p>Note</p> <ul style="list-style-type: none"> It is necessary to set the ACD feature to enable (→ see [Enable ACD] in 4.3.10 ACD Settings [Line1]–[Line16] in the Web user interface or "ACD_ENABLE_n" in 5.3.14 Call Center Settings in the configuration file). 	<p>Off: Ready mode for incoming calls Red on: Unavailable Flashing red slowly: Wrap Up</p>
Line Status	Used to confirm the status of each line. This allows the function key to work as a Line key such as seizing a line in order to make or receive a call.	-
Call Forward	Used to forward incoming calls to the assigned extension in the key.	-
Phonebook	Used to open the phonebook.	-
Call History	Used to open the incoming/outgoing call log.	-

Button	Description	Lamp Indication
Simultaneous Ring ^{**1}	<p>Enables parallel ringing. Up to 10 locations can be specified to ring simultaneously when you receive a call.</p> <p>Note</p> <ul style="list-style-type: none"> It is necessary to set the XSI feature to enable (→ see [Enable Xtended Service] and [Server Address] in 4.3.7 Xtended Service Settings in the Web user interface or "XSI_ENABLE" and "XSI_SERVER" in 5.3.11 XSI Settings in the configuration file). 	<p>Off: Simultaneous Ring off Blue on: Simultaneous Ring on</p>
Hoteling (Hospitality) ^{**1}	<p>Used to log in/log out of the Call Center Hoteling Event.</p> <p>Note</p> <ul style="list-style-type: none"> It is necessary to set the Hoteling (Hospitality) feature to enable (→ see [Enable Call Center] and [Hoteling Event] in 4.3.11 Call Center Settings [Line1]–[Line16] in the Web user interface or "CALL_CENTER_ENABLE_n" and "CC_HOTELING_EVENT_n" in 5.3.14 Call Center Settings in the configuration file). 	-
Transfer	Used to transfer a call to the assigned extension in the key with confirmation, during a conversation.	-
Blind Transfer	Used to transfer a call to the assigned extension in the key without confirmation, during a conversation.	-
Conference	Used to establish a multiple-party conversation (conference).	-
Directed Call Pickup	Used to answer an incoming call arriving at the specified telephone number.	-
Call Park ^{**1}	Used to transfer a call to Call Parking.	-
Call Park Retrieve ^{**1}	Used to retrieve a parked call (Call Parking).	-

6.3.1 Settings using Web User Interface Programming

Button	Description	Lamp Indication
Network Camera	Used to connect to a Network Camera.	-

*1 This is an optional feature and may not be supported on your phone system.

6.3.1 Settings using Web User Interface Programming

To set Flexible Keys

1. In the Web user interface, click the **[Telephone]** tab, and then click **[Flexible Key Settings]**.
2. Enter settings as described in the following table.
When it is necessary to set both parameter 1 and parameter 2, enter a comma between the values.

Button	Parameter 1		Parameter 2	
	Description	Value	Description	Value
One Touch Dial	Phone Number	Up to 32 digits	Line No.	1–16
BLF (Busy Lamp Field) ^{*1}	Phone Number	Up to 32 digits	Line No.	1–16
Line	Line No.	1–16	-	-
ACD	Line No.	1–16	-	-
Wrap Up	Line No.	1–16	-	-
Line Status	-	-	-	-
Call Forward	Phone Number	Up to 32 digits	-	-
Phonebook	Classification	<ul style="list-style-type: none"> • 0: Personal & Shared • 1: Personal Phonebook • 2: Shared Phonebook 	Category	1–9
Call History	Classification	<ul style="list-style-type: none"> • 0: Call History • 1: Missed Calls • 2: Incoming Calls • 3: Outgoing Calls 	-	-
Simultaneous Ring	Line No.	1–16	-	-
Hoteling (Hospitality)	-	-	-	-
Transfer	Phone Number	Up to 32 digits	-	-
Blind Transfer	Phone Number	Up to 32 digits	-	-
Conference	Phone Number	Up to 32 digits	-	-
Directed Call Pickup	Phone Number	Up to 32 digits	Line No.	1–16

Button	Parameter 1		Parameter 2	
	Description	Value	Description	Value
Call Park	Call parking number ²	Up to 16 digits	-	-
Call Park Retrieve	Park retrieve number ²	Up to 16 digits	Line No.	1–16
Network Camera	Network Camera Number	1–16	-	-

¹ More than 48 BLF keys can be programmed, but LED status indication is available only up to 48 keys.

² Values may vary depending on your phone system dealer/service provider.

[Setting Example]

The following screen shows an example of setting flexible keys.

No.	Type	Parameter	Label Name
1	ACD	6	ACD6
2	BLF	9876543210,1	301
3	One Touch Dial	0123456789	Home
4	Line	1	Line 1
5	BLF	11223344,2	302
6	One Touch Dial	123454321	Office
7	ACD	5	ACD6

Description:

- Button 1 is set to log in and log out of an ACD group on line 6.
- Buttons 2 and 5 are set to show the status of a certain extension. They can also be used to call that extension and transfer calls to it.¹
- Buttons 3 and 6 are set to make calls to a certain destination using the One-Touch Dialing feature.
- Button 4 is set to make calls to a certain destination using the Line feature.
- Button 7 is set to log in and log out of an ACD group on line 5.

¹ You can also assign extension numbers automatically to BLF buttons using the information in the server's resource list without having to input information here.

6.3.2 Settings using Configuration File Programming

Flexible keys can be configured by configuration file programming using a combination of 3 parameters:

6.3.2 Settings using Configuration File Programming

- Parameter 1 refers to either "FLEX_BUTTON_FACILITY_ACTx" or "DSS_BUTTON_FACILITY_ACTx".
- Parameter 2 refers to either "FLEX_BUTTON_FACILITY_ARGx" or "DSS_BUTTON_FACILITY_ARGx".
- Parameter 3 refers to either "FLEX_BUTTON_LABELx" or "DSS_BUTTON_LABELx".

Details about parameters 1 and 2 are explained in the following table.

Note

- For parameter 2, value 1 and value 2 must be separated by a comma.

Parameter 1	Parameter 2		
Value	Value 1	Value 2	Note
X_PANASONIC_IPTE L_ONETOUCH	Phone Number (Max. 32 characters)	Line Number (1– 16)	The total maximum number of characters is 35. Line 1 is set when value 2 is "1", "0", or "None".
X_PANASONIC_IPTE L_BLF	Phone Number (Max. 32 characters)	Line Number (1– 16)	The total maximum number of characters is 35. Line 1 is set when value 2 is "1", "0", or "None".
X_PANASONIC_IPTE L_LINE	Line Number (1– 16)	-	The default line is set when value 1 is "0" or "None".
X_PANASONIC_IPTE L_ACD	Line Number (1– 16)	-	The default line is set when value 1 is "0" or "None".
X_PANASONIC_IPTE L_LINESTATUS	-	-	-
X_PANASONIC_IPTE L_FORWARD	Phone Number (Max. 32 characters)	-	-
X_PANASONIC_IPTE L_PHONEBOOK	1 (Personal Phonebook)	Category Number (1–9)	The search by name screen is displayed when value 2 is "0" or "None".
	2 (Shared Phonebook)	-	-
	0 or None (Select Phonebook)	-	-
X_PANASONIC_IPTE L_CALLLOG	1 (Missed Call)	-	-
	2 (Incoming Call Log)		
	3 (Outgoing Call Log)		
	0 or None (Select Logs)		
X_PANASONIC_IPTE L_PARARING	Line Number (1– 16)	-	-
X_PANASONIC_IPTE L_HOTELING	-	-	-

Parameter 1	Parameter 2		
Value	Value 1	Value 2	Note
X_PANASONIC_IPTE L_TRANSFER	Phone Number (Max. 32 characters)	-	-
X_PANASONIC_IPTE L_BLINDTRANSFER	Phone Number (Max. 32 characters)	-	-
X_PANASONIC_IPTE L_CONFERENCE	Phone Number (Max. 32 characters)	-	-
X_PANASONIC_IPTE L_DIRECTPICKUP	Phone Number (Max. 32 characters)	Line Number (1– 16)	-
X_PANASONIC_IPTE L_CALLPARK	Call parking number (Max. 16 characters)	-	If value 1 is not set, the value of "NUM_PLAN_PARKING" is used.
X_PANASONIC_IPTE L_PARKRETRIEVE	Park retrieve number (Max. 16 characters)	Line Number (1– 16)	If value 1 is not set, the value of "NUM_PLAN_PARK_RETRIEVIN G" is used.
X_PANASONIC_IPTE L_NETWORKCAMERA	Network Camera Number (1–16)	-	-
X_PANASONIC_IPTE L_APPLICATION	-	-	-

6.4 Broadsoft XSI (Xtended Services Interface)

6.4.1 Outline

BroadWorksXsi is an API library used to support the integration of Internet service-based BroadWorks functionality to create web applications and mashups (web application hybrids).

This product uses the Broadsoft XSI (Xtended Services Interface) to run the following services.

1. Remote Office
2. AnyWhere
3. Simultaneous Ring Personal
4. Calling Line ID Delivery Blocking (Anonymous Call)
5. Call Forward
6. Do Not Disturb
7. Anonymous Call Rejection

(1) Remote Office

The Remote Office function allows you to use your home phone or cellular phone as your office phone. All incoming calls are forwarded from the IP phone to the Remote Office phone number.

6.4.2 XSI Service Settings

(2) AnyWhere

The AnyWhere function is for remote users to easily access their IP phone's functions (such as making and receiving calls, and voicemail) from any phone.

(3) Simultaneous Ring Personal

The Simultaneous Ring Personal function enables up to 10 other phone numbers to ring at the same time an IP phone receives a call.

(4) Calling Line ID Delivery Blocking (Anonymous Call)

The Calling Line ID Delivery Blocking (Anonymous Call) function sets the caller information for calls made from an IP phone to "Anonymous Call".

(5) Call Forward

The Call Forward function forwards incoming calls to an IP phone to a specified phone number.

* When Feature Key Synchronization is set (FWD_DND_SYNCHRO_ENABLE_n="Y", see page 290), the Call Forward function will not operate as an XSI function.

(6) Do Not Disturb

The Do Not Disturb function rejects incoming calls to the IP phone.

* When Feature Key Synchronization is set (FWD_DND_SYNCHRO_ENABLE_n="Y", see page 290), the Do Not Disturb function will not operate as an XSI function.

(7) Anonymous Call Rejection

The Anonymous Call Rejection function rejects calls made to the IP phone as Anonymous Calls.

6.4.2 XSI Service Settings

Phone settings for using XSI services can be set using configuration parameters or the Web user interface (administrators only).

See **4.3.7 Xtended Service Settings** for making settings using the Web user interface.

The following parameter names will be displayed and can be set as needed.

Parameter Name	Description	Reference
XSI_ENABLE	Enables XSI services.	page 200
XSI_SERVER	Specifies the XSI server.	page 200
XSI_SERVER_TYPE	Specifies the communication method.	page 201
XSI_SERVER_PORT	Specifies the port used for communication with the XSI server.	page 201
XSI_USERID_n	Specifies the user name for each user (account) that will use XSI.	page 201
XSI_PASSWORD_n	Specifies the password for each user (account) that will use XSI.	page 201
XSI_PHONEBOOK_ENABLE_n	Specifies whether to enable or disable the Xsi phonebook service.	page 201
XSI_PHONEBOOK_CYCLIC_INTVL	Specifies the interval, in minutes, between periodic checks for updates of the Xsi Directory (Phonebook) files.	page 202

Parameter Name	Description	Reference
XSI_PHONEBOOK_RESYNC_DURATION	Specifies the time range, in minutes, during which units will access the server at a random time.	page 202
XSI_PHONEBOOK_TYPE_n	Specifies the type of Xsi phonebook.	page 202
XSI_CALLLOG_ENABLE_n	Specifies whether to enable or disable the Xsi call log service.	page 202
XSI_VISUAL_VM_ENABLE_n	Specifies whether to enable or disable the Visual Voice Mail feature of the selected line.	page 203
XSI_SIP_CREDENTIALS_ENABLE	Specifies whether to enable or disable the XSI SIP Credentials feature.	page 203

Note





To change settings for the following XSI services using a unit, the parameter ADMIN_ABILITY_ENABLE="Y" (see page 288) must be set. (When ADMIN_ABILITY_ENABLE="N" is set, the settings can only be viewed.)

- Remote Office ("**Remote Office**")
- AnyWhere ("**Anywhere**")
- Simultaneous Ring Personal ("**SimultaneousRing**")
- Calling Line ID Delivery Blocking ("**Anonymous Call**")
- Anonymous Call Rejection ("**Block Anonymous**")

Note

The text in parentheses are shown on the unit display.

Operations for accessing the above XSI services

1. In standby mode, tap  or  to select "**Advanced Settings**".
2. Tap "**Call Settings**".
3. Tap  or  to select "**Remote Office**", "**Anywhere**", "**SimultaneousRing**", "**Anonymous Call**", or "**Block Anonymous**".

For details, refer to the Operating Instructions on the Panasonic Web site (→ see **Introduction**).

6.5 BroadCloud (Presence)

6.5.1 Outline

This product supports the following BroadCloud functions.

(1) BroadCloud Buddies

View the information of your Buddies.

(2) BroadCloud Favorites

View the information of your Buddies that have been marked as Favorites.

(3) BroadCloud Presence

Shares presence statuses.

6.5.2 BroadCloud (Presence) Function Settings

Phone settings for using XMPP functions can be set using configuration parameters or the Web user interface (administrators only).

See **4.3.8 UC Settings** for making settings using the Web user interface.

The following parameter names will be displayed and can be set as needed.

Parameter Name	Description	Reference
UC_ENABLE	Enables BroadCloud services.	page 205
UC_USERID	Specifies user IDs for the BroadCloud server.	page 205
UC_PASSWORD	Specifies passwords for the BroadCloud server.	page 205
XMPP_SERVER	Specifies the IP address or FQDN of the XMPP server.	page 205
XMPP_PORT	Specifies the communication port for XMPP.	page 205
XMPP_TLS_VERIFY	Specifies the TLS (Transport Layer Security) certification validation type for protocol communication.	page 206
XMPP_ROOT_CERT_PATH	Specifies the path (URL) of the ROOT certificate for XMPP.	page 206
XMPP_CLIENT_CERT_PATH	Specifies the path (URL) of the Client certificate for XMPP.	page 206
XMPP_PKEY_PATH	Specifies the path (URL) of the private key for XMPP.	page 206

Section 7

Firmware Update

This section explains how to update the firmware of the unit.

7.1 Firmware Server Setup

No special server is necessary for the firmware update. You can use an HTTP, HTTPS, FTP, or TFTP server as the firmware server by simply setting its URL.

Note

- It is recommended to select a time for updating in which the unit will not be used. (For details about the timing of updating configuration files, see **2.2.4 Downloading Configuration Files**.)

7.2 Firmware Update Settings

Firmware updates are provided by the manufacturer when necessary.

The firmware update will be executed by setting the corresponding parameters using configuration file programming (→ see **5.3.6 Firmware Update Settings**) or Web user interface programming (→ see **4.7.2 Firmware Maintenance**). The following shows the parameters and the setting procedures:

Firmware Update Enable/Disable

- In a configuration file, add the line, `FIRM_UPGRADE_ENABLE="Y"`.
- In the Web user interface, click the **[Maintenance]** tab, click **[Firmware Maintenance]**, and then select **[Yes]** for **[Enable Firmware Update]**.

Firmware Version Number

- In a configuration file, specify the new version number in "`FIRM_VERSION`".

Firmware Server URL

- In a configuration file, specify the URL in "`FIRM_FILE_PATH`".
- In the Web user interface, click the **[Maintenance]** tab, click **[Firmware Maintenance]**, and then enter the URL in **[Firmware File URL]**.

Configuration Parameter Example

By setting the parameters as shown in the following example, the unit will automatically download the firmware file from the specified URL, "`http://firm.example.com/firm/01.050.fw`", and perform the update operation if the currently used firmware version is older than 01.050.

Example

```
FIRM_UPGRADE_ENABLE="Y"  
FIRM_VERSION="01.050"  
FIRM_FILE_PATH="http://firm.example.com/firm/01.050.fw"
```

7.3 Executing Firmware Update

After configuring the firmware update settings in the configuration file, the firmware will be updated when the configuration file is downloaded. The firmware update procedure is detailed below.

The firmware update process

Note

- Downgrading the firmware is not recommended. Operation cannot be guaranteed after performing a downgrade.

Step 1

The unit downloads a configuration file from the provisioning server.

- For details about setting the timing of when configuration files are downloaded, see **2.2.4 Downloading Configuration Files**.

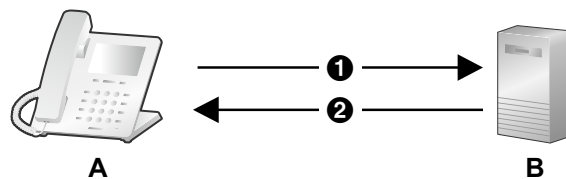

- 1 Provisioning Server Address
- 2 Configuration File
- A. SIP Phone
- B. Provisioning Server

Step 2

The unit compares the version number of the firmware in the configuration file to the unit's current firmware version. (In this example, the unit is using version 01.000 and the configuration file specifies version 01.050.)

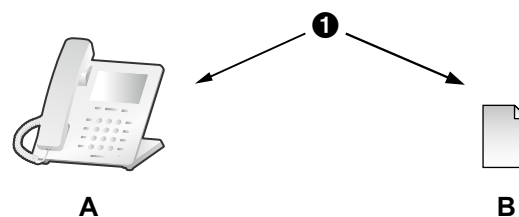

- 1 Compare
- A. SIP Phone
Current Version 01.000
- B. Provisioned Configuration File
FIRM_VERSION="01.050"

Step 3

When a newer firmware version is specified in the configuration file, the unit will download the firmware from the address specified under "FIRM_FILE_PATH" in the configuration file.

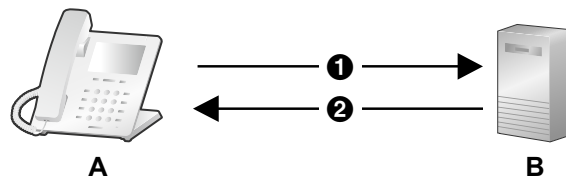

- 1 <http://firm.example.com/firm/01.050.fw>
- 2 01.050.fw
- A. SIP Phone
- B. Firmware Server

Step 4

Once the newer firmware is downloaded, it is applied to the unit and the unit automatically restarts.



Version 01.050 Updated

7.3 Executing Firmware Update

Section 8

Troubleshooting

This section provides information about troubleshooting.

8.1 Troubleshooting

If you still have difficulties after following the instructions in this section, disconnect the unit from the AC outlet, then connect the AC adaptor again. If using PoE, disconnect the LAN cable, then connect the LAN cable again.

General Use

Problem	Cause/Solution
The display is blank.	<p>The unit is not designed to function when there is a power failure. Make sure that the device supplying PoE is receiving power and that the Ethernet cable is properly connected.</p> <p>(If you are using a PoE hub, the number of devices that you can connect simultaneously is limited by the amount of power supplied by the hub.)</p> <p>If an AC adaptor is connected, confirm that the AC adaptor is connected and receiving power.</p>
I cannot hear a dial tone.	<ul style="list-style-type: none"> • Network settings may not be correct. • Many installation issues can be resolved by resetting all the equipment. First, shut down your modem, router, hub, unit, and PC. Then turn the devices back on, one at a time, in this order: modem, router, hub, unit, PC. • If you cannot access Internet Web pages using your PC, check to see if your phone system is having connection issues in your area. • Check the VoIP status in the Web user interface and confirm that each line is registered properly (→ see To check the setting status in the Web user interface in this section). • Check that the SIP server address, URLs of the configuration files, encryption key, and other required settings are correct. • Check the firewall and port forwarding settings on the router. • For details about the settings, consult your network administrator or phone system dealer.

Making/Answering Calls, Intercom

Problem	Cause/Solution
The unit does not ring.	<ul style="list-style-type: none"> • Check the VoIP status in the Web user interface and confirm that each line is registered properly (→ see To check the setting status in the Web user interface in this section). • Check that the SIP server address, URLs of the configuration files, encryption key, and other required settings are correct. • Check the firewall and port forwarding settings on the router. • Check [Call Control] for each line in the [Telephone] tab in the Web user interface. <ul style="list-style-type: none"> – If [Enable Do Not Disturb] is set to [Yes], the unit does not receive calls (→ see 4.6.2.1 Call Features). – If [Enable Call Forwarding No Answer] is set to [Yes], the unit does not receive calls (→ see 4.6.2.1 Call Features). – If [Enable Block Anonymous Call] is set to [Yes], the unit does not receive anonymous calls (→ see 4.6.2.1 Call Features). • Check that [Enable Do Not Disturb], [Enable Call Forwarding No Answer], and [Enable Block Anonymous Call] are not controlled by your phone system. • For details about settings, consult your network administrator or phone system dealer.
I cannot make a call.	<ul style="list-style-type: none"> • Check the VoIP status in the Web user interface and confirm that each line is registered properly (→ see To check the setting status in the Web user interface in this section). • Check that the SIP server address, URLs of the configuration files, encryption key, and other required settings are correct. • Check the firewall and port forwarding settings on the router. • For details about settings, consult your network administrator or phone system dealer.

Password for Web User Interface Programming

Problem	Cause/Solution
I have lost the login password of the Web user interface for the Administrator or User account.	<ul style="list-style-type: none"> • Consult your network administrator or phone system dealer. For security reasons, it is recommended that the passwords are set again immediately (→ see 4.4.3 Admin Password Settings or 4.4.2 User Password Settings).

Time

Problem	Cause/Solution
The time is not correct.	<ul style="list-style-type: none"> In the Web user interface, you can set NTP synchronization and DST (Summer Time) control to adjust the time automatically (→ see 4.4.4 Time Adjust Settings). If the time is still incorrect even after setting NTP synchronization, check the firewall and port forwarding settings on the router.

Error Codes

During operation, error messages might appear on the unit. The following table lists these messages and possible causes and solutions.

Error code	Probable Cause	Solution
Error:001	LAN disconnection detected	Check the LAN cables connections.
Error:002	Overlapping IP addresses	Check the IP addresses and re-set them. For making settings using a unit, see 1.1.3 Basic Network Setup.
Error:003	The REGISTER of the SIP server has not been registered.	Consult your network administrator or phone system dealer.

Error Message

Error Message	Probable Cause	Solution
Need Repair	Hardware failure	Consult your network administrator or phone system dealer.

Checking the Status of the Unit

You can check the status of the unit by using Web user interface programming (→ see **4.2.2 Network Status** and **4.2.3 VoIP Status**) or by looking at system logs (see **5.3.38 Logging Settings**) sent from the unit.

To check the setting status in the Web user interface

1. Click the **[Status]** tab, and then click **[Network Status]** to check the network settings.
2. Check the status displayed.
3. Click **[VoIP Status]** to check the VoIP settings.
4. Check the status displayed.

To check the setting status using the Unit

1. In standby mode, tap **▶** or **◀** to select "System Settings".
2. Tap "Status".

Export Logging File

Export the log file using the Web user interface (see **4.7.3 Export Logging File**).

Note

Panasonic System Networks Co., Ltd.

1-62, 4-chome, Minoshima, Hakata-ku, Fukuoka 812-8531, Japan

Copyright:

This material is copyrighted by Panasonic System Networks Co., Ltd., and may be reproduced for internal use only. All other reproduction, in whole or in part, is prohibited without the written consent of Panasonic System Networks Co., Ltd.

© Panasonic System Networks Co., Ltd. 2016