



---

**AN5116-06B**

**Optical Line Terminal Equipment**

**Product Description**

**Version: A/1**

**Code: MN000002128**

**FiberHome Telecommunication Technologies Co., Ltd.**

**November 2014**



# Thank you for choosing our products.

---

We appreciate your business. Your satisfaction is our goal. We will provide you with comprehensive technical support and after-sales service. Please contact your local sales representative, service representative or distributor for any help needed at the contact information shown below.

## **Fiberhome Telecommunication Technologies Co., Ltd.**

Address: No. 67, Guanggu Chuangye Jie, Wuhan, Hubei, China

Zip code: 430073

Tel: +6 03 7960 0860/0884 (for Malaysia)

+91 98 9985 5448 (for South Asia)

+593 4 501 4529 (for South America)

Fax: +86 27 8717 8521

Website: <http://www.fiberhomegroup.com>



# Legal Notice

---

烽火通信®

**FiberHome**®

**GONST**®

**FONST**®

**e-Fim**®

**CiTRANS**®

**E-jet**®

**IBAS**®

**Freelink**®

**FonWeaver**®

**OTNPlanner**™

**SmartWeaver**™

are trademarks of FiberHome Telecommunication Technologies Co., Ltd.  
(Hereinafter referred to as FiberHome)

All brand names and product names used in this document are used for identification purposes only and are trademarks or registered trademarks of their respective holders.

All rights reserved

No part of this document (including the electronic version) may be reproduced or transmitted in any form or by any means without prior written permission from FiberHome.

Information in this document is subject to change without notice.



# Preface

---

## Related Documentation

Document	Description
<i>AN5116-06B Optical Line Terminal Equipment Product Description</i>	Introduces functional features, application model, network management system and technical specifications of AN5116-06B. It aims to acquaint users with the equipment, its performance and technology applied, and provide users with technical support.
<i>AN5116-06B Optical Line Terminal Equipment Hardware Description</i>	Introduces the appearance, structure, functions, technical specifications, and operating method for the AN5116-06B's cabinet, PDP, subrack, cards, cables and wires, facilitating users' mastery of the hardware features of the equipment.
<i>AN5116-06B Optical Line Terminal Equipment Installation Guide</i>	Introduces the overall installation and acceptance inspection procedures from unpacking inspection to power-on examination after the AN5116-06B is delivered on site, and provides reference information (e.g. safety principles and wiring scheme of various interfaces) to guide users to install the equipment.
<i>AN5116-06B Optical Line Terminal Equipment Quick Installation Guide</i>	Mainly use diagrams to introduce the installation of the AN5116-06B components such as cabinet, subrack and so on, and the connection and layout of cables and wires, aiming to guide the hardware installation engineer to install the equipment in a quick and normative way.
<i>AN5116-06B Optical Line Terminal Equipment EPON Configuration Guide</i>	Introduces the method for configuring the EPON services supported by the AN5116-06B via the UNM2000, such as basic configuration, voice service configuration, data service configuration, multicast service configuration, and software upgrading configuration, to guide users on start-up for various services and software upgrading.
<i>AN5116-06B Optical Line Terminal Equipment GPON Configuration Guide</i>	Introduces the method for configuring the GPON services supported by the AN5116-06B via the UNM2000, such as basic configuration, voice service configuration, data service configuration, multicast service configuration, and software upgrading configuration, to guide users on start-up for various services and software upgrading.

## Version

Version	Description
A	This manual corresponds to the AN5116-06B of Version 4.0. Initial version.

## Intended Readers

This manual is intended for the following readers:

- ◆ Marketing personnel
- ◆ Commissioning engineers
- ◆ Operation and maintenance engineers

To utilize this manual, these prerequisite skills are necessary:

- ◆ EPON technology
- ◆ 10G EPON technology
- ◆ GPON technology
- ◆ Multicast technology
- ◆ NGN voice technology
- ◆ Ethernet switch technology
- ◆ Computer network technology









# Conventions

## Terminology Conventions

Terminology	Convention
AN5116-06B	AN5116-06B Optical Line Terminal Equipment
UNM2000	FiberHome UNM2000 Network Convergence Management System
EC4B	4×EPON-C Interface Card (Type B)
EC8B	8×EPON-C Interface Card (Type B)
ECOB	16×EPON Interface Card (Type B)
GC4B	4×GPON-B Interface Card (Type B)
GC8B	8×GPON_C Interface Card (Type B)
GCOB	16 Port GPON OLT Line Card (Type B)
XG8A	8×10G EPON Service Card
C155A	1×STM-1 Optical Interface Card (CES Mode)
CE1B	32×E1 Interface Card (Type B)
TIMA	Time Board
HSWA	Core Switch Card (Type A)
HSWD	Core Switch Card (Type D)
HU1A	4×GE + 1×10GE Uplink Card
HU1B	Uplink Five Port Board (4×GE+1×10GE, supporting synchronous Ethernet)
HU2A	2×GE +2×10GE Optical Interface Uplink Card
GU6F	6×GE Optical Interface Uplink Card
GU6B	GPON Uplink Board (6×GE, supporting synchronous Ethernet)
GSOF	16×GE Interface Card

## Symbol Conventions

Symbol	Meaning	Description
	Note	Important features or operation guide.
	Caution	Possible injury to persons or systems, or cause traffic interruption or loss.

Symbol	Meaning	Description
	Warning	May cause severe bodily injuries.
	Jump	Jumps to another step.
	Cascading menu	Connects multi-level menu options.
	Bidirectional service	The service signal is bidirectional.
	Unidirectional service	The service signal is unidirectional.

# Contents

---

Preface.....	I
Related Documentation .....	I
Version .....	II
Intended Readers .....	II
Conventions .....	III
<b>1</b> Product Introduction.....	1-1
<b>1.1</b> Product Positioning.....	1-2
<b>1.2</b> Functions and Features .....	1-3
<b>1.2.1</b> EPON / GPON / 10G EPON Integrated Access Capability	1-3
<b>1.2.2</b> Interface Type.....	1-6
<b>1.2.3</b> Support to IPv6 Protocol .....	1-7
<b>1.2.4</b> Multicast Function.....	1-9
<b>1.2.5</b> Voice Function.....	1-11
<b>1.2.6</b> Layer 3 Routing Function .....	1-12
<b>1.2.7</b> VLAN Function .....	1-13
<b>1.2.8</b> QoS Guarantee .....	1-15
<b>1.2.9</b> Security Mechanism .....	1-17
<b>1.2.10</b> Reliability Design .....	1-19
<b>1.2.11</b> Maintainability and Manageability.....	1-21
<b>1.3</b> List of Functions and Features .....	1-23
<b>2</b> Product Application.....	2-1
<b>2.1</b> Network Introduction .....	2-2
<b>2.2</b> Network Application .....	2-2
<b>2.2.1</b> Triple Play Application.....	2-2
<b>2.2.2</b> MSTP Service Application.....	2-3
<b>2.2.3</b> TDM Service Application.....	2-4
<b>2.2.4</b> Residence and Home Application.....	2-5
<b>2.2.5</b> Small Cell Bearing Application .....	2-7
<b>2.2.6</b> High Bandwidth Access Application .....	2-8
<b>2.2.7</b> Wi-Fi Hot Spot Covering Application.....	2-10

<b>3</b>	Product Composition.....	3-1
<b>3.1</b>	Logical Architecture .....	3-2
<b>3.2</b>	Hardware Structure.....	3-3
<b>3.2.1</b>	19-inch Cabinet .....	3-3
<b>3.2.2</b>	21-inch Cabinet (without the Anti-dust Screen) .....	3-5
<b>3.2.3</b>	21-inch Cabinet (with the Anti-dust Screen) .....	3-8
<b>3.2.4</b>	PDP .....	3-10
<b>3.2.5</b>	Subrack.....	3-11
<b>3.2.6</b>	Card .....	3-14
<b>3.3</b>	Software Architecture.....	3-15
<b>4</b>	System Management.....	4-1
<b>4.1</b>	Management Mode.....	4-2
<b>4.2</b>	CLI Network Management System .....	4-3
<b>4.3</b>	The UNM2000 .....	4-3
<b>4.3.1</b>	Function .....	4-4
<b>4.3.2</b>	Operating Environment .....	4-5
<b>4.3.3</b>	Network Mode .....	4-7
<b>5</b>	Technical Specification and Standard .....	5-1
<b>5.1</b>	Performance Parameter.....	5-2
<b>5.1.1</b>	Overall Performance .....	5-2
<b>5.1.2</b>	Access Capability .....	5-5
<b>5.1.3</b>	Reliability Specifications .....	5-6
<b>5.2</b>	Interface Specifications .....	5-7
<b>5.2.1</b>	Specifications of Interfaces on the EC4B / EC8B / ECOB Card .....	5-7
<b>5.2.2</b>	Specifications of Interface on the XG8A Card .....	5-7
<b>5.2.3</b>	Interface Specifications of the GC4B / GC8B / GCOB Card .....	5-8
<b>5.2.4</b>	Interface Specifications of the HU1A / HU1B / HU2A Card .....	5-9
<b>5.2.5</b>	Interface Specifications of the HU4A Card .....	5-10
<b>5.2.6</b>	Interface Specifications of the GU6F / GU6B / GSOF Card .....	5-11
<b>5.2.7</b>	Interface Specifications of the CE1B Card .....	5-12
<b>5.2.8</b>	Interface Specifications of the C155A Card.....	5-12

	<b>5.2.9</b>	Interface Specifications of the HSWA Card.....	5-13
	<b>5.2.10</b>	Interface Specifications of the HSWD Card.....	5-14
	<b>5.2.11</b>	Interface Specifications of the TIMA Card.....	5-14
<b>5.3</b>		Mechanical Dimensions and Weight.....	5-15
<b>5.4</b>		Power Supply and Power Consumption.....	5-15
<b>5.5</b>		Equipment Room Requirement .....	5-16
	<b>5.5.1</b>	Power Supply Requirement.....	5-16
	<b>5.5.2</b>	Working Environment.....	5-16
<b>5.6</b>		Standard and Protocol .....	5-16
	<b>5.6.1</b>	Environment Standard .....	5-17
	<b>5.6.2</b>	Electromagnetic Compatibility Standard .....	5-18
	<b>5.6.3</b>	Safety Standard.....	5-19
	<b>5.6.4</b>	10G EPON Standard .....	5-20
	<b>5.6.5</b>	EPON Standard.....	5-20
	<b>5.6.6</b>	GPON Standard .....	5-21
	<b>5.6.7</b>	Ethernet Protocol.....	5-21
	<b>5.6.8</b>	Routing Protocol .....	5-22
	<b>5.6.9</b>	NGN Protocol .....	5-22
	<b>5.6.10</b>	IMS Protocol.....	5-23
	<b>5.6.11</b>	TDM Service Standard.....	5-23
	<b>5.6.12</b>	Time Standard .....	5-23
	<b>5.6.13</b>	Other Standard and Protocol.....	5-24
Appendix A		Abbreviations .....	A-1



# Figures

---

Figure 1-1	The AN5116-06B's Position in the Network.....	1-2
Figure 1-2	Physical Interfaces of the AN5116-06B.....	1-6
Figure 2-1	Network Diagram of the AN5116-06B .....	2-2
Figure 2-2	The Triple Play Application of the AN5116-06B.....	2-3
Figure 2-3	Network of the AN5116-06B in MSTP Service .....	2-4
Figure 2-4	Network of the AN5116-06B in TDM Service.....	2-5
Figure 2-5	Application of the AN5116-06B in Residential Districts and Families.....	2-6
Figure 2-6	Application of the AN5116-06B in the Small Cell .....	2-7
Figure 2-7	Application of the AN5116-06B in High Bandwidth Access .....	2-9
Figure 2-8	Application of the AN5116-06B in the Wi-Fi Hot Spot Covering .....	2-11
Figure 3-1	Logical Architecture of the AN5116-06B .....	3-2
Figure 3-2	Appearance of a 19-inch Cabinet .....	3-4
Figure 3-3	Typical Layout of a 19-inch Cabinet.....	3-5
Figure 3-4	Appearance of a 21-inch Cabinet (without the Anti-dust Screen) .....	3-6
Figure 3-5	Typical Layout of a 21-inch Cabinet (without the Anti-dust Screen)..	3-7
Figure 3-6	Appearance of a 21-inch Cabinet (with the Anti-dust Screen).....	3-8
Figure 3-7	Typical Layout of a 21-inch Cabinet (with the Anti-dust Screen) .....	3-9
Figure 3-8	Appearance of the PDP .....	3-11
Figure 3-9	Subrack Structure .....	3-12
Figure 3-10	Subrack Slot Allocation and Typical Configuration .....	3-13
Figure 3-11	Software Architecture of the AN5116-06B System .....	3-16
Figure 4-1	Network Diagram for the CLI Network Management System.....	4-3
Figure 4-2	Network Example .....	4-8





# Tables

---

Table 1-1	Interfaces of the AN5116–06B.....	1-6
Table 1-2	List of Functions and Features .....	1-23
Table 3-1	Description of Subrack Structure .....	3-12
Table 3-2	Card Function List.....	3-14
Table 4-1	Hardware Configuration Requirement for the Server End.....	4-5
Table 4-2	Software Configuration Requirements for the Server End .....	4-6
Table 4-3	Hardware Configuration Requirement for the Client End .....	4-6
Table 4-4	Software Configuration Requirement for the Client End .....	4-7
Table 5-1	The Overall Performance of the Equipment .....	5-2
Table 5-2	The DBA Performance of the Equipment.....	5-2
Table 5-3	The Ethernet Service Performance of the Equipment.....	5-2
Table 5-4	The Voice Service Performance of the Equipment .....	5-4
Table 5-5	The TDM Service Performance of the Equipment .....	5-4
Table 5-6	The Access Capability of the Equipment.....	5-5
Table 5-7	The Card Reliability Specifications .....	5-6
Table 5-8	The Equipment Reliability Specifications .....	5-6
Table 5-9	Specifications of Interfaces on the EC4B / EC8B / ECOB Card .....	5-7
Table 5-10	Specifications of Interface on the XG8A Card .....	5-7
Table 5-11	Interface Specifications of the GC4B / GC8B / GCOB Card (Class B +) .....	5-8
Table 5-12	Interfaces Specifications of the GC4B / GC8B / GCOB Card (Class C +) .....	5-9
Table 5-13	Specifications of 10GE Optical Interfaces on the the HU1A / HU1B / HU2A Card.....	5-9
Table 5-14	Specifications of GE Optical Interfaces on the the HU1A / HU1B / HU2A Card .....	5-10
Table 5-15	Specifications of Ethernet Electrical Interfaces on the the HU1A / HU1B / HU2A Card.....	5-10
Table 5-16	Ethernet Optical Interface Specifications of the HU4A Card .....	5-10

Table 5-17	Specifications of Ethernet Optical Interfaces on the GU6F / GU6B / GSOF Card .....	5-11
Table 5-18	Specifications of Ethernet Electrical Interfaces on the GU6F / GU6B / GSOF Card .....	5-11
Table 5-19	Interface Specifications of the CE1B Card .....	5-12
Table 5-20	Interface Specifications of the C155A Card.....	5-12
Table 5-21	Interface Specifications of the HSWA Card.....	5-13
Table 5-22	Interface Specifications of the HSWD Card.....	5-14
Table 5-23	Electrical Interface Specifications of the TIMA Card .....	5-14
Table 5-24	Optical Interface Specifications of the TIMA Card .....	5-14
Table 5-25	Mechanical Dimensions and Weight of the Equipment.....	5-15
Table 5-26	Power Consumption of the Equipment's Cards .....	5-15

# 1 Product Introduction

---

The following introduces the applications, functions and features of the AN5116-06B.

- Product Positioning
- Functions and Features
- List of Functions and Features

# 1.1 Product Positioning

The AN5116-06B is a new intelligent carrier-class EPON / GPON / 10G EPON integrated access product offered by FiberHome. It can provide large-capacity, high-bandwidth and low-cost voice, data and video SERVICE access solutions, so as to meet the rapid growth of network service requirements in the information age.

## Functional Positioning

The AN5116-06B's functional positioning is described as follows:

- ◆ Used together with the remote end ONU (Optical Network Unit) as the office end OLT (Optical Line Terminal) in the EPON / GPON / 10G EPON system.
- ◆ Supports integrated broadband / narrowband services, such as VoIP, data, IPTV and CATV.
- ◆ Performs Layer 2 and Layer 3 data aggregation functions, and can be applied in different access network scenarios.

## Network Positioning

See Figure 1-1 for the network positioning of the AN5116-06B.

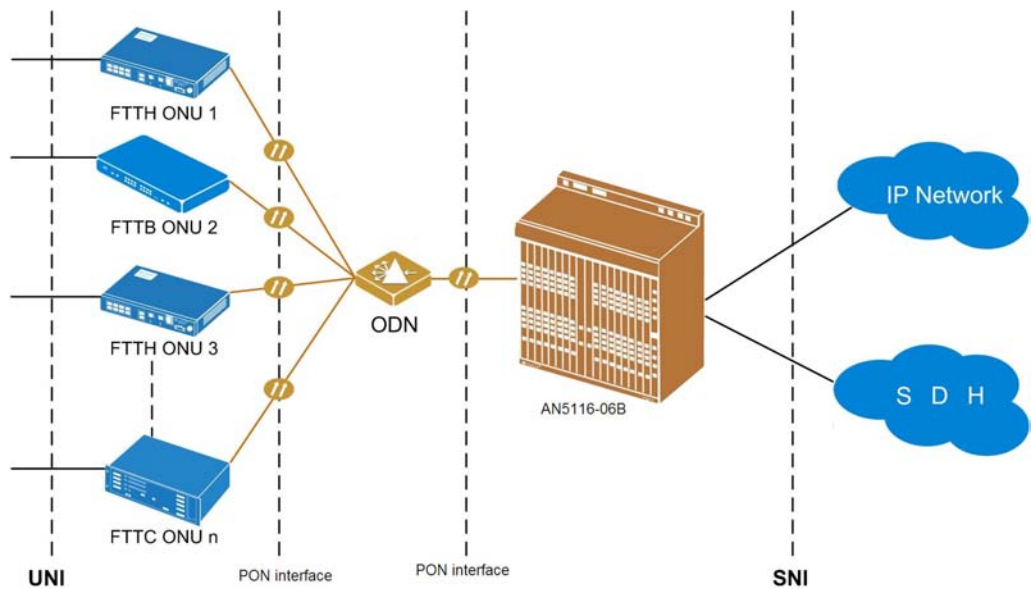

Figure 1-1 The AN5116-06B's Position in the Network

The AN5116-06B is usually placed in the equipment room of a residential community or the central office. The network positioning of the equipment is described as follows:

- ◆ At the network side, the AN5116-06B provides GE or 10GE uplink port(s) for connection to a BMAN (Broadband Metro Area Network) via the BRAS (Broadband Remote Access Server). It can input and output clock signals through various clock interfaces, so as to set up the transmission network for the clock synchronization information.
- ◆ At the subscriber side, the AN5116-06B provides the subscribers with various services incorporated in a single fiber, such as voice, data and video services, via an ODN (Optical Distribution Network) to cater for subscribers' individualized demands.

## 1.2 Functions and Features

The following introduces the functions and features of the equipment.

### 1.2.1 EPON / GPON / 10G EPON Integrated Access Capability

The AN5116-06B is the EPON / GPON / 10G EPON integrated access equipment that can simultaneously support EPON, GPON, and 10G EPON services, so as to overcome the restrictions on access bandwidth and cater for subscribers' demands for high bandwidth services.

#### EPON Access Capability

- ◆ Supports all the EPON functions defined in the IEEE 802.3-2008 standard.
- ◆ Supports the extended OAM function.
- ◆ Possesses good downward compatibility. Supports various kinds of ONUs, such as SBU, SFU, MTU, cassette MDU (including LAN type and xDSL type), and shelf-based MDU.
- ◆ Provides EPON transmission with large bandwidth capacity:
  - ▶ Downlink rate: 1.25 Gbit/s

- ▶ Uplink rate: 1.25 Gbit/s
- ◆ Supports the DBA (Dynamic Bandwidth Allocation) algorithm.
  - ▶ The minimum bandwidth allocation granularity of the DBA is no more than 256 kbit/s.
  - ▶ The minimum configurable bandwidth of the DBA is no less than 512 kbit/s.
  - ▶ The accuracy of the DBA is better than  $\pm 5\%$ .
- ◆ Supports long-distance transmission. The maximum differential transmission distance can be more than 20 km.
- ◆ Provides a high split ratio of 1:64 by using PON technology, so as to improve capacity, conserve fiber consumption, and facilitate network reach.

### 10G EPON Access Capability

- ◆ Supports the 10G EPON functions defined in the IEEE 802.3av standard.
- ◆ Possesses good downward compatibility. Supports various kinds of ONUs, such as SBU, SFU, MTU, cassette MDU (including LAN type and xDSL type), and shelf-based MDU.
- ◆ Provides transmission with large bandwidth capacity, and the 10G EPON port supports the symmetric and asymmetric modes:
  - ▶ Symmetric mode: The uplink rate and downlink rate are both 10 Gbit/s or 1.25 Gbit/s.
  - ▶ Asymmetric mode: The downlink rate is 10 Gbit/s, and the uplink rate is 1.25 Gbit/s.
- ◆ Supports the DBA algorithm for uplink bandwidth allocation, and supports three bandwidth types: the fixed bandwidth, assured bandwidth, and best effort bandwidth.
- ◆ Provides a high split ratio of 1:64, and can reach 1:128 if optical power permits, which improves capacity, conserves fiber consumption, and facilitates network reach.
- ◆ Supports long-distance transmission. The maximum differential transmission distance can be more than 20 km.

## GPON Access Capability

- ◆ Conforms to ITU-T G.984 serial standards, with good interoperability.
- ◆ Supports the extended OAM function.
- ◆ Possesses good downward compatibility. Supports various kinds of ONUs, such as SBU, SFU, MTU, cassette MDU (including LAN type and xDSL type), and shelf-based MDU.
- ◆ Provides GPON transmission with large bandwidth capacity:
  - ▶ Downlink rate: 2.5 Gbit/s
  - ▶ Uplink rate: 1.25 Gbit/s
- ◆ Supports both SBA (Static Bandwidth Allocation) and DBA (Dynamic Bandwidth Allocation) algorithms.
  - ▶ SBA ensures a fixed bandwidth for each ONU.
  - ▶ DBA allocates bandwidth according to subscriber's traffic dynamically.
  - ▶ The minimum bandwidth allocation granularity of the DBA is no more than 256 kbit/s.
  - ▶ The minimum configurable bandwidth of the DBA is no less than 512 kbit/s.
  - ▶ The accuracy of the DBA is better than  $\pm 5\%$ .
- ◆ Supports long-distance transmission. The maximum differential transmission distance can be more than 20 km.
- ◆ Provides a high split ratio of 1:64, and can reach 1:128 if the optical power permits, which improves capacity, conserves fiber consumption, and facilitates network reach.
- ◆ Supports data transmission in an efficient way:
  - ▶ Encapsulates all the data to be transmitted into the 125us frames (fixed length frames) via the new GEM (GPON Encapsulation Mode) encapsulation protocol. In this way, a smaller number of transmission overhead bytes are used, and the transmission efficiency is enhanced.
  - ▶ The transmission efficiency can reach 93% when the downlink rate is 2.5 Gbit/s and the uplink rate is 1.25 Gbit/s.

- ◆ Supports IEEE 1588V2 to implement the high-precision clock and time synchronization in the network and meet the service demands.

## 1.2.2 Interface Type

The AN5116-06B supports various physical interface types, as shown in Figure 1-2.

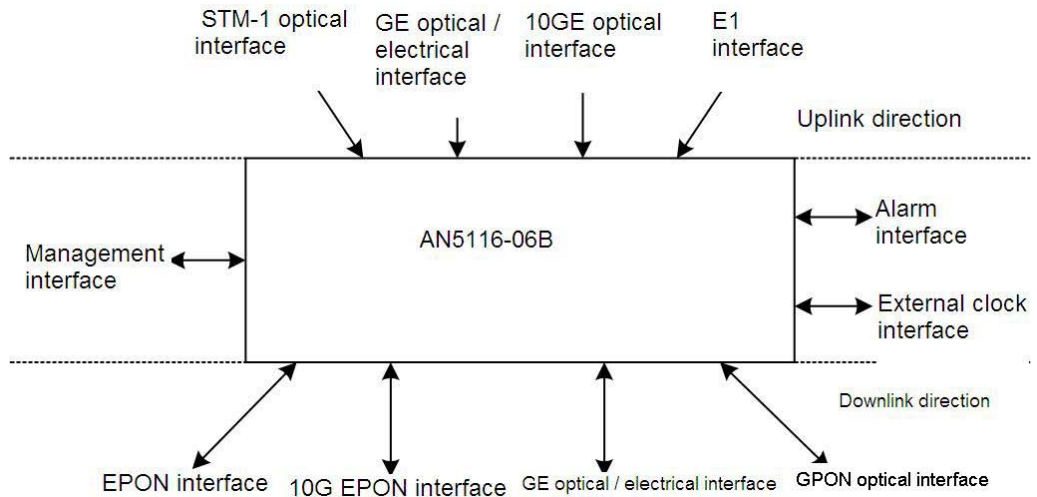

Figure 1-2 Physical Interfaces of the AN5116-06B

The functions of various interfaces on the AN5116-06B are shown in Table 1-1.

Table 1-1 Interfaces of the AN5116-06B

Interface Class	Interface Type	Function
Uplink interface	10GE optical interface	Provides 10GE Ethernet uplink optical interface.
	GE optical interface	Provides GE Ethernet uplink optical interface.
	GE electrical interface	Provides GE Ethernet uplink electrical interface.
	STM-1 optical interface	Provides connection to the STM-1 optical interface of the transmission equipment.
	E1 electrical interface	Provides connection to the E1 interface of the transmission equipment.
Subscriber interface	EPON optical interface	Provides EPON subscriber interface.
	10G EPON optical interface	Provides 10G EPON subscriber interface.
	GPON optical interface	Provides GPON subscriber interface.



Table 1-1 Interfaces of the AN5116–06B (Continued)

Interface Class	Interface Type	Function
	GE optical interface	Provides GE Ethernet cascade optical interface.
	GE electrical interface	Provides GE Ethernet cascade optical interface.
Management interface	FE interface	Supports out-of-band GUI management.
	10GE / GE interface	Supports in-band GUI management.
	RJ-45 interface (using the RS-232 interface protocol)	Supports out-of-band local CLI management.
External clock interface	Clock coaxial interface	Provides input and output of the external BITS clock.
Alarm interface	RJ-45 interface	Transports subrack alarm signals to the PDP.

### 1.2.3 Support to IPv6 Protocol

The AN5116-06B supports the transparent transmission of IPv6 services, the IPv4/v6 dual stack technology, and the network management system for the IPv6 equipment. While maintaining the current network architecture, it supports the coexistence of the IPv4 and IPv6 services to enable smooth evolution to IPv6.

#### IPv6 VLAN Functions

- ◆ Supports the transparent transmission of IPv4 / IPv6 services.
- ◆ Supports identifying the IPv4 and IPv6 packets, and sets different VLANs for them.

#### IPv6 QoS Functions

- ◆ Supports identifying IPv6 packets, and sets different Ethernet priorities for Pv4 and IPv6 packets.
- ◆ Supports classification of the uplink service flow based on the following objects: IPv6 source / destination address, IP protocol type (such as TCP, UDP, and ICMPv6), IPv6 priority field (Traffic Class) and IPv6 flow label field (Flow Label).

- ◆ Supports the mapping between the classification of the uplink IPv6 service flow and the uplink IPv6 service priority, and supports the Ethernet PRI field as the priority ID.

### IPv6 Security Functions

- ◆ Supports the uplink / downlink data frame filtering based on the following objects: IPv6 source / destination address, TCP port number, UDP port number.
- ◆ Supports filtering the DHCPv6 packets and IPv6 multicast data streams from users.
- ◆ Supports limiting rates of packets compliant with certain protocols (such as DHCPv6 and ICMPv6).
- ◆ Supports binding the IPv6 address (or its prefix) with the port or VLAN; supports binding the user IPv6 address (or its prefix) based on the static configuration with the user port or VLAN.

### IPv6 Multicast Functions

- ◆ Supports the MLD Proxy function.
- ◆ Supports the IPv6 controllable multicast function.
- ◆ Supports configuring multiple VLANs; supports configuring the IPv4 and IPv6 multicast programs in different multicast VLANs.
- ◆ Supports adding and deleting the multicast program sources.
- ◆ Supports managing the authorities of multicast subscribers.
- ◆ Supports managing the multicast service packets.
- ◆ Supports previewing the multicast programs.
- ◆ Supports pre-configuring the number of programs that one subscriber can watch at the same time.
- ◆ Supports statistics of the multicast service information.
- ◆ Supports recording the online / offline logs of multicast subscribers and reporting the logs to the server collectively.

## IPv6 Port Isolation Functions

Supports port tagging via the DHCPv6 relay agent Option 18 / Option 37.

## Other IPv6 Related Functions

Supports application programs related to the IPv6 protocol stack, such as the network management system for IPv6 equipment and ICMPv6.

## 1.2.4 Multicast Function

The subscriber side and network side interfaces of the AN5116-06B support IGMP V2 / V3 and MLD V1 / V2, and can provide subscribers with flexible multicast solutions by virtue of the P2MP features of the PON.

### Supported Multicast Functions

- ◆ Supports the IGMP V2 / V3 protocol.
- ◆ Supports the MLD V1 / V2 protocol.
- ◆ Supports the IGMP Proxy, IGMP Snooping, and MLD Proxy functions.
- ◆ Supports prejoin function which enables joining pre-configured multicast group by automatically send joining message uplink.
- ◆ Supports preview function.
- ◆ Supports fast leave function.
- ◆ Supports multicast cascade when accessed in the EPON / GPON /10G EPON mode.
- ◆ Supports cross-VLAN multicast.
- ◆ Supports management and identification of subscribers and program sources based on multicast VLAN.
- ◆ Supports management of multicast group members via IGMP Proxy, IGMP Snooping, and MLD Proxy messages.
- ◆ Supports dynamic management of joining / leaving and maintaining of multicast members via IGMP / MLD Report / Leave and Query messages.

- ◆ Multicast statistics supported: count of subscriber joining / leaving multicast group, total duration of watching and average duration of watching for each multicast group or subscriber port.
- ◆ Supports online query of multicast information: ability to query the online multicast groups, group members and status of the core switch card, the line card and the ONU hierarchically.
- ◆ Supports multicast service CDR (Call Detail Record) function: including subscriber port information, address of multicast group, joining and leaving time, leaving pattern (forcibly or freely), and authority information.
- ◆ Supports controllable multicast function, and provides multicast subscriber-based control, including information display, log and statistics of subscriber joining / leaving multicast group events, which can effectively prevent protocol attack, illegal multicast sources, illegal rebroadcasting, and illegal receiver to guarantee operators' revenue.

### Supported Multicast Routing Functions

- ◆ Supports the PIM-SM protocol.
- ◆ The AN5116-06B supports the PIM protocol, and connects the subscriber side multicast router and the network side multicast router via the OLT uplink interface.
- ◆ The AN5116-06B supports the PIM protocol, and it can work cooperatively with Layer 2 IGMP multicast protocol.
  - ▶ In case that the multicast router does not support the IGMP protocol, the uplink port of the AN5116-06B will enable the PIM protocol and connect to the PIM router to set up the multicast route.
  - ▶ If the multicast router supports the IGMP, the AN5116-06B will provide multicast services to the subscribers under the OLT via Layer 2 IGMP functions.
- ◆ Supports PIM transparent transmission: The AN5116-06B can enable the PIM transparent transmission to achieve transparent transmission for OLT network side PIM router and the ONU side PIM router.

## 1.2.5 Voice Function

The AN5116-06B supports using the H.248, MGCP and SIP protocols to achieve NGN voice functions. It can meet the requirements of carrier-class speech quality, management and operations.

It uses the ONU to process NGN voice signals, and uses a softswitch or IMS to perform call control, so as to provide VoIP access for analog subscriber lines.

### Implementation Mode of NGN Voice Services

- ◆ Supports the ITU-T H.248, MGCP and SIP protocols to form a network with the SoftSwitch and enable the NGN services.
- ◆ Supports the SIP protocol to form a network with the IMS and enable the NGN services.

### Supported NGN Voice Functions

- ◆ Provides the analogue line testing function for POTS interfaces.
- ◆ Supports multi-MGC list.
- ◆ The VLAN of each voice channel supports IEEE 802.1Q and PRI setting.
- ◆ Supports QinQ encapsulation for voice services.
- ◆ The call processing capability is 25k BHCA.
- ◆ The percent of call completed is larger than 99.999%.
- ◆ Supports IP telephone access for POTS subscribers.
- ◆ Supports T.30 / T.38-based FoIP (Fax over IP).
- ◆ Supports transparent transportation of MoIP.
- ◆ Supports pulse accounting and polarity-reversal accounting.
- ◆ Supports the IP CENTERX service.
- ◆ Supports the following intelligent services and user-defined services when assisted by the softswitch or IMS:
  - ▶ Calling number identification (CNID) presentation and restriction.
  - ▶ Call waiting.

- ▶ Three party service.
- ▶ Alarm clock service.
- ▶ Call forwarding (unconditional, busy and no answer).
- ▶ Immediate hotline.
- ▶ Outgoing call blocking.
- ▶ Distinctive ring.

## 1.2.6 Layer 3 Routing Function

The equipment performs flexible Layer 3 routing functions, and supports multiple routing protocols.

### Supporting OSPF Dynamic Routing

- ◆ Fast convergence: Sends updated messages immediately when the network topology architecture changes to enable synchronization in the autonomous system.
- ◆ Loopback free: The OSPF calculates the route according to the collected link status information using the shortest-path tree algorithm, and the algorithm itself ensures that no loopback routes will be generated.
- ◆ Area division: The network of the autonomous system is divided into areas for management. Thus the routing information transmitted between areas is simplified, and the occupied network bandwidth is reduced.
- ◆ Equal-cost multi-path routing: Provides multiple equal-cost routes leading to the same destination.
- ◆ Route level: Four levels of routes are used, and the sequence of priority is described as follows (from higher to lower): intra-area route, inter-area route, external route of type 1, and external route of type 2.
- ◆ Message authentication: Provides interface-based message authentication, so as to ensure the security of route calculation.
- ◆ Multicast transmission: Supports the multicast address.
- ◆ The maximum number of dynamic routes is 4000.

## Supporting RIP Dynamic Routing

- ◆ Supports RIP1 and RIP2 routing protocols.
- ◆ Supports external route tags: Performs flexible control of routes according to route tags in the routing policy.
- ◆ The messages carry the mask information, and the route aggregation and CIDR are supported.
- ◆ Supports setting the next hop, and the system can select the optimum address of the next hop in the broadcast network.
- ◆ Supports authentication of protocol messages: Provides two authentication modes, i.e., PAP-based clear-text authentication and MD5 authentication, so as to enhance the security.
- ◆ Supports two message transmission modes: broadcast and multicast.

## Supporting Static Routing

- ◆ Supports configuring static routes manually, and the Metric of the route is 0.
- ◆ The maximum number of static routes is 1000.

## **1.2.7 VLAN Function**

The equipment provides powerful VLAN stacking and VLAN translation functions. It can manage various subscribers' services effectively and enhance the network security.

### QinQ VLAN / VLAN Stacking Functions Supported by the Equipment

VLAN (Virtual Local Area Network) is a data exchange technology that logically divides the local area network equipment into a network segment to form a virtual working group.

The standard for QinQ VLAN/VLAN stacking is IEEE802.1ad, which is upgraded from the IEEE802.1Q standard for VLAN. Its core concept is to encapsulate the VLAN tag of the subscriber's private network in a service VLAN tag of public network so that the subscriber's traffic crosses the provider's backbone network with two layers of tags. This provides subscribers with a relatively simple Layer 2 VPN tunnel, and can effectively overcome the VLAN ID addressing space limit of 4k addresses.

The QinQ VLAN functions supported by the AN5116-06B are described as follows:

- ◆ Supports subscriber and service differentiation through VLANs.
- ◆ Supports setting the subscriber's SVLAN based on card, PON port, or ONU.
- ◆ Supports VLAN number extension.

By adding QinQ VLANs, the number of VLANs is increased to 4096×4096 on the basis of existing VLANs.

- ◆ Supports flexible QinQ features:

The system can add inner or outer VLAN based on the value of source MAC address, destination MAC address, source IP address, destination IP address, L4 source port number, L4 destination port number, Ethernet type, inner VLAN ID, outer VLAN ID, service type, time-to-live, protocol type, L1 CoS, and L2 CoS.

- ◆ Supports selective QinQ for one port.

Supports basic QinQ and selective QinQ at the same time on a port: allowing both double-tagged and single-tagged services.

## VLAN Translation Functions Supported by the Equipment

VLAN translation means that the OLT or ONU equipment translates subscriber side VLAN tags into network side VLAN tags. This function can reduce carriers' maintenance workload and protect the distribution layer network and the core network.

The VLAN translation function provided by the AN5116-06B can be in one of the following three forms:

- ◆ 1:1 translation:



The uplink data VLANs of each subscriber are translated into the corresponding network side VLANs. That is, the subscriber data VLANs correspond to network side VLANs one by one.

◆ N:1 translation:

The VLAN aggregation function. In the uplink direction, a number of uplink VLANs are aggregated and translated into a unique network-side VLAN; in the downlink direction, the network-side VLAN is reversely mapped into multiple VLANs on the subscriber side.

◆ Hybrid translation:

The combination of the 1:1 VLAN translation and the N:1 VLAN translation is supported.

## 1.2.8 QoS Guarantee

The equipment has a sound QoS guarantee mechanism and supports end-to-end QoS solution for the entire network. For different clients and services, it provides network services of different qualities, which lays the foundation for management of various services.

### QoS Capability of EPON

- ◆ Supports the uplink port's flow-based policies, including packet filter, re-direction, flow mirroring, traffic statistics, traffic monitoring, queue scheduling, rate control, priority policing and translation.
- ◆ Supports the uplink port's packet filtering and classification based on source MAC address, destination MAC address, Ethernet type, VLAN, CoS, source IP address, destination IP address, IP port and protocol type.
- ◆ The OLT supports three queue scheduling mechanisms: SP, WRR and SP + WRR; and each port has eight priority queues.
- ◆ Supports CoS remarking and CoS copy:  
Changes the original CoS value in the subscriber's data message, or copies the CoS value of the CVLAN to the SVLAN.
- ◆ Supports flow labeling and shaping.
- ◆ Supports 1024 QoS rules.

- ◆ Supports rate control of ports.
- ◆ Supports bandwidth control of an EPON port, with a granularity of 32 kbit/s.
- ◆ The ONU only supports the single-LLID technology.

### QoS Capability of 10G EPON

- ◆ Supports the uplink port's flow-based policies, including packet filter, re-direction, flow mirroring, traffic statistics, traffic monitoring, queue scheduling, rate control, priority policing and translation.
- ◆ Supports the uplink port's packet filtering and classification based on source MAC address, destination MAC address, Ethernet type, VLAN, CoS, source IP address, destination IP address, IP port and protocol type.
- ◆ The OLT supports three queue scheduling mechanisms: SP, WRR and SP + WRR; and each port has eight priority queues.
- ◆ Supports CoS remarking and CoS copy:  
Changes the original CoS value in the subscriber's data message, or copies the CoS value of the CVLAN to the SVLAN.
- ◆ Supports flow labeling and shaping.
- ◆ Supports 1024 QoS rules.
- ◆ Supports rate control of ports.
- ◆ Supports bandwidth control of an 10G EPON port, with a granularity of 8 kbit/s.
- ◆ The ONU only supports the single-LLID technology.

### QoS Capability of GPON

- ◆ Supports the uplink port's flow-based policies, including packet filter, re-direction, flow mirroring, traffic statistics, traffic monitoring, queue scheduling, rate control, priority policing and translation.
- ◆ Supports the uplink port's packet filtering and classification based on source MAC address, destination MAC address, Ethernet type, VLAN, CoS, source IP address, destination IP address, IP port and protocol type.
- ◆ The OLT supports three queue scheduling mechanisms: SP, WRR and SP + WRR; and each port has eight priority queues.
- ◆ Supports CoS remarking and CoS copy:

Changes the original CoS value in the subscriber's data message, or copies the CoS value of the CVLAN to the SVLAN.

- ◆ Supports flow shaping, and supports dynamic adjustment of the traffic output rate. The OLT performs data buffering, and sends out the data when available bandwidth exists.
- ◆ Supports traffic policing, monitoring a certain kind of traffic that enters a certain interface.
- ◆ Supports 1024 QoS rules.
- ◆ Supports the DBA (Dynamic Bandwidth Allocation) algorithm with a bandwidth control granularity of 32 kbit/s.
- ◆ Provides flexible QoS and SLA functions:

Classifies priority queues according to MAC address, 802.1p priority, 802.1Q VLAN tag, IP ToS, IP address, and TCP / UDP address; supports up to eight service levels.
- ◆ Supports the uplink port's flow-based rate limiting and mirroring.
- ◆ Supports T-CONT service scheduling of type 1 to type 5.
- ◆ Provides uplink DBA and SBA functions, supporting both SR (Status Report) mode and NSR (None Status Report) mode of DBA.
- ◆ The ONU supports the multi-T-CONT technology.

Each ONU supports up to eight T-CONTs, which are classified based on source MAC address, destination MAC address, source IP address, destination IP address, TCP, UDP, ToS, CoS, Ethernet type and protocol type.

## 1.2.9 Security Mechanism

Designed with carrier-class reliability, the equipment can fully guarantee the security of subscribers' services.

### System Side Security Insurance Measures

- ◆ Supports L2 to L7 packet filtering, performing illegal frame filtering based on source MAC address, destination MAC address, source IP address, destination IP address, port No., Ethernet type, protocol type, VLAN and VLAN range, so as to prevent prevent illegal attempts to access the Internet.

- ◆ Supports protection against DOS attack to enhance the anti-attack capability.
- ◆ Supports ACL (Access Control List)-based permission / denial control functions.
- ◆ Supports protection against ICMP (Internet Control Message Protocol) / IP message attack.
- ◆ Supports protection against ARP (Address Resolution Protocol) attack.
- ◆ Both GUI and CLI network management systems can provide operator accounts with different operating rights, so as to ensure operating security of the network management system.
- ◆ Supports automatic reporting of ONU SN and MAC address to the network management system.
- ◆ Supports multiple validity authentication modes of ONU, including based on the physical ID, logical ID (without password), logical ID (with password), physical ID / logical ID (with password), physical ID / logical ID (without password), password, physical ID / physical password, etc.
- ◆ Supports broadcast storm control.
- ◆ Supports frame filtering and rate limiting.
- ◆ Supports loop test.

### Subscriber Side Security Measures

- ◆ Supports access security control through DHCP Option 82 and PPPOE+. The AN5116-06B can insert physical information into protocol messages of DHCP request dial or PPPOE dial. When used in combination with a verifying system, it can effectively and dynamically control subscriber access to specific network resources, so as to greatly facilitate troubleshooting and attack positioning.
- ◆ Supports DHCP snooping. The ONU snoops subscriber information such as MAC address, IP address, lease time and VLAN ID, so as to trace and locate DHCP subscriber's IP address and port by establishing and maintaining a DHCP snooping binding table. In addition, it directly discards illegal messages (ARP spoofing messages and the messages that modify IP address randomly). These illegal messages are not compliant with the binding table entries. Therefore, it guarantees DHCP environment integrity and consistency.

- ◆ Supports limit on the maximum number of MAC addresses learned, to prevent MAC attack.
- ◆ Supports limit on the number of MAC addresses that access a single LAN interface of an ONU.
- ◆ Supports limit on the number of multicast groups that a single LAN interface of an ONU can join.
- ◆ Supports port binding, such as dynamic binding of FE interface and MAC address, to guarantee validity of subscribers accessing the network.
- ◆ Supports AES-128 encryption and decryption algorithm to guarantee the security of subscribers' data.

## 1.2.10 Reliability Design

System reliability is a major concern in the system design, software design and hardware design of the AN5116-06B. The equipment provides sound redundancy protection of power supply, fans, cards and interfaces, and optical path protection switching mechanism, so as to ensure the normal operation of the equipment.

### Card Protection

- ◆ Supports hot insertion of cards.
- ◆ Supports 1+1 active / standby switching function of the core switch cards to enable seamless switching. The service interruption duration is less than 50ms in the active / standby switching. After the switching of the core switch cards is completed, you need not modify the configuration of the uplink interfaces, which facilitates the user's maintenance and management operations.
- ◆ Supports 1+1 redundancy protection for the uplink cards, and supports the Trunk protection, dual-homing protection and MSTP protection for the uplink interfaces.
  - ▶ When the uplink cards are set to 1+1 active / standby protection, the interfaces of the two uplink cards are one-to-one protected.
    - If the HU4A card is used as the uplink card, the equipment can provide up to four 10GE uplink ports.

- If the GU6F card is used as the uplink card, the equipment can provide up to six GE uplink ports.
- If the HU1A card is used as the uplink card, the equipment can provide up to four GE uplink ports and one 10GE uplink port.
- If the HU2A card is used as the uplink card, the equipment can provide up to two GE uplink ports and two 10GE uplink ports.
- ▶ When the uplink ports are set to the Trunk mode, the bandwidth of uplink ports can be extended and load equalization for interfaces in the Trunk group is performed automatically. When a port in the Trunk group fails, the flow of the failed port is automatically shared between other ports of the Trunk group. The twelve GE uplink ports of the two uplink cards can form maximally six Trunk groups and each Trunk group can support maximally 12 member ports. The 10GE uplink ports of the uplink cards can make up maximally two 10GE uplink Trunk groups.
- ▶ When the uplink ports are set to dual-homing protection, the two uplink ports are connected to the IP bearer network via two sets of uplink equipment to perform dual-homing protection. When one of the two links fails, the services on the failed link will be automatically switched to the other link, so that traffic remains unblocked.
- ▶ When the uplink FE / GE interfaces of the AN5116-06Bs are connected to form an MSTP ring network between the equipment, the demand of service protection can be met and the optical fiber resources can be saved. When link faults occur, a new connected network without the redundancy path can be formed.
- ◆ Supports the inter-card protection for the TDM cards.

## PON Protection

- ◆ Supports 1:1 protection for any PON ports, including different PON ports inside one chip, PON ports in different chips on the same PON interface card, and the PON ports on different PON interface cards in the same equipment.
- ◆ Supports the switching of Type B and Type C defined by the CTC standards; the service interruption period during protection switching on the optical link is less than 200 ms.
- ◆ Supports both the automatic switching and the forced switching.

## Power Supply Protection

- ◆ Two power supply cards work for dual-power input and provide protection against reverse polarity connection.
- ◆ The power supply cards support a distributed power-fed mode and all cards are fed with power independently. Any fault in one card will not influence the other cards. This greatly improves equipment reliability and stability.

## Fan Protection

Provides fan running indicator LEDs to indicate the running status of fans.

## 1.2.11 Maintainability and Manageability

The equipment provides four network management functions: configuration management, security management, performance management and fault management. These functions together guarantee network QoS and facilitate users' routine maintenance and fault diagnosis.

## Management and Maintenance Measures

- ◆ Supports local and remote management measures.
- ◆ Supports GUI and CLI network management systems, and performs uniform management of OLTs and ONUs via the UNM2000 developed by FiberHome.
- ◆ Supports in-band and out-of-band management modes.
- ◆ Supports SNMP.
- ◆ Supports the Telnet protocol for remote access to and management of the equipment.
- ◆ Supports multiple management IP addresses / VLANs, and allows multiple management servers to manage the same equipment simultaneously.

## Terminal Management

- ◆ Supports the remote management of ONUs via the OLT (as the proxy of the network management system). The OLT manages the remote EPON ONU using the OAM extension protocol, and manages the remote GPON ONU using the OMCI protocol.

- ◆ Supports pre-configuration of an ONU by the OLT. When the pre-configured ONU gets registered, the OLT will authorize the ONU and apply the pre-configured data to the ONU automatically. This makes service configuration more convenient.
- ◆ Supports automatic detection and testing of the ONU.
- ◆ Supports multiple authentication modes of ONU, including those based on password, physical ID (without password), physical ID (with password), logical ID (without password), logical ID (with password), physical ID + logical ID (without password), and physical ID + logical ID (with password), etc.
- ◆ Supports interconnection with carrier's management system, and receives configuration from the operator's resource management system.

## Alarm Management

- ◆ Provides additional alarm information to help users find causes of the alarms and identify the solution.
- ◆ Supports the system log function which can record the key configuration changes to the system to assist fault analysis and isolation.
- ◆ Supports signaling tracing of speech to facilitate isolation of voice service faults.
- ◆ Supports PSTN line quality and performance testing which can isolate telephone line faults.
- ◆ Provides performance supervision and detection of optical power levels to facilitate optical line maintenance.
- ◆ Supports local and remote end loopback tests to isolate subscriber line faults.

## Performance Management

- ◆ Supports output of various statistic report forms, such as performance statistics report form and alarm statistics report forms, to facilitate routine maintenance.
- ◆ The network management system supports collection, query and analysis of performance data.



## Security Management

The management system allows different levels of management authority to be defined on a per user basis using the user management setting table.

# 1.3 List of Functions and Features

See Table 1-2 for the functions supported by the AN5116-06B.

Table 1-2 List of Functions and Features

Type	Function
Access features	EPON access
	GPON access
	10G EPON access
	Ethernet access
	E1/STM-1 access
EPON/10G EPON/GPON access	EPON/10G EPON/GPON terminal management
Layer 2 switching functions	Supporting 802.1Q VLAN
	Supporting selective QinQ (VLAN Stacking)
	Independent learning of MAC addresses
	Shared learning of MAC addresses
	Globally clearing Layer 2 forwarding table
	Supporting the OLT forwarding data based on the MAC address
	Supporting configuring the aging time of the MAC addresses for the OLT and ONU
	Supporting Layer 2 port dynamic aggregation and the LACP
	Supporting STP protocol (IEEE802.1D), RSTP protocol (IEEE 802.1w), and MSTP protocol (IEEE 802.1s)
Port mirroring	Supporting ingress and egress mirroring
	Supporting flow mirroring
Port trunking	Supporting IEEE 802.3ad.
	Supporting up to six trunk groups; up to 12 member ports can be assigned to a trunk group.
Port isolation	Supporting EPON / GPON / 10G EPON port isolation
	Supporting the uplink port isolation
QoS functions	Supporting two rate three color based on traffic

Table 1-2 List of Functions and Features (Continued)

Type	Function
	Supporting single rate three color based on traffic
	Supporting IPv4 / IPv6 QoS
Multicast functions	PIM-SM
	IGMP Proxy / Snooping and MLD Proxy
	IGMP V1 / V2 / V3 and MLD V1 / V2 protocol
	Multicast VLAN
	Copying and broadcasting of multicast
	Statistics of multicast information
	Management of multicast subscribers
	Management of multicast programs
	The CDR function of multicast services
	Supporting controllable multicast
Voice functions	VoIP voice service
	Supporting H.248, SIP, and MGCP protocols
	PPPoE configuration
	DHCP configuration
	Query of NGN statistics information
	Query of NGN source status
	Interconnection of voices inside PON
TDM functions	Supporting multiple clock modes
	Online query of E1 status
	Supporting E1 loopback
	Providing E1 and STM-1 uplink interfaces
Layer 3 functions	VLAN Layer 3 interface
	ARP agent
	Supporting DHCP relay, DHCP snooping or DHCP server
	Isolating illegal DHCP Server
	RIP dynamic routing
	OSPF dynamic routing
	Static routing
Line identifier functions	Supporting proxy of Option18 and Option37 via the DHCPv6
	Supporting DHCP Option82 and PPPoE+
Network features	Supporting Ethernet cascade network

Table 1-2 List of Functions and Features (Continued)

Type	Function
	BFD (Bidirectional Forwarding Detection)
Operations and maintenance	Remote operation and user management
	Classification of operation authorities
	Management of equipment abnormality
	Version and data management
	Saving and query of performance statistics and historical data
	Remote upgrading of software
	Automatic rollback for software upgrade
	Synchronization between equipment configuration and the ANM2000 configuration
	Supporting the License function
Clocks	Clock inside the system
	BITS clock
	E1 line clock
	1588v2 clock
	Recovery of self-adaptive clock
	Synchronizing Ethernet clock
System redundancy backup functions	Supporting 1:1 protection for any PON port
	Supporting dual redundancy of the uplink cards
	Supporting dual redundancy of the core switch cards
	Supporting 1+1 protection for power interfaces
Security features	Each uplink port supporting up to 120 ACL rules
	Supporting multiple validity authentication modes of ONU, including those based on the physical ID, logical ID (without password), logical ID (with password), physical ID + logical ID (with password), physical ID + logical ID (without password), password, physical ID + physical password, etc.
	Supporting limit on the maximum number of MAC addresses learned to prevent MAC attack
	Supporting filtering packets based on MAC addresses
	Supporting packet filtering and port binding based on the source MAC address, destination MAC address, Ethernet type, VLAN, CoS, source IP address, destination IP address, IP port and protocol type

Table 1-2 List of Functions and Features (Continued)

<b>Type</b>	<b>Function</b>
	Supporting protection against DoS attacks

## 2 Product Application

---

The following introduces the network description, technical application, and site application of the AN5116-06B.

Network Introduction

Network Application

## 2.1 Network Introduction

The AN5116-06B is suitable for the FTTH / FTTC / FTTB / FTTO application. Usually it is placed in a residential community or the central office.

Figure 2-1 shows the network diagram of the AN5116-06B.

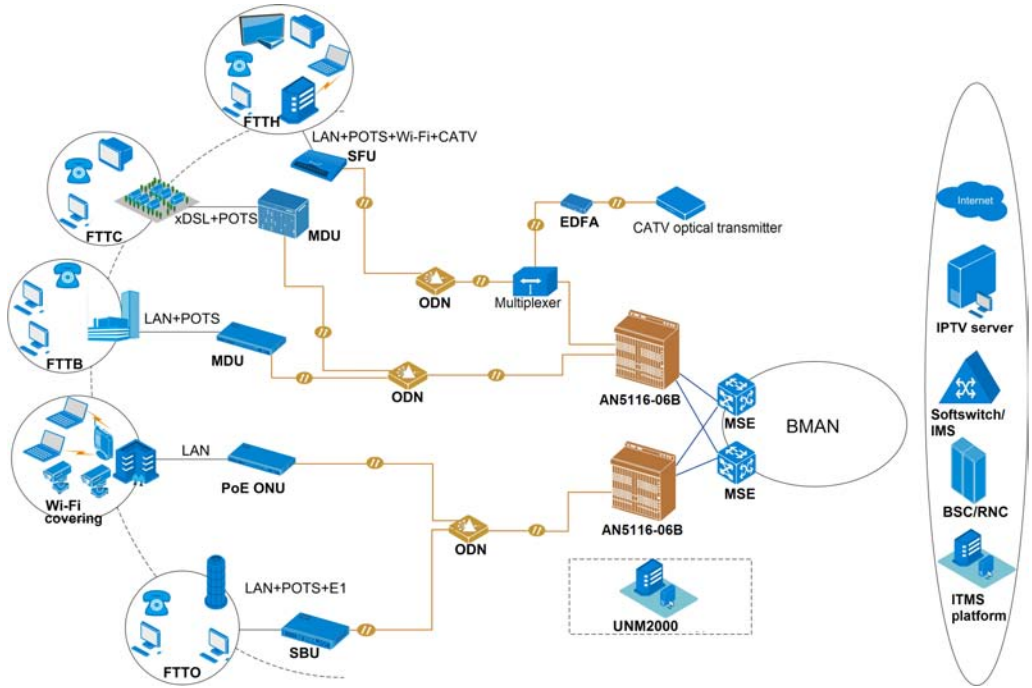

Figure 2-1 Network Diagram of the AN5116-06B

## 2.2 Network Application

The following introduces the network application of the equipment.

### 2.2.1 Triple Play Application

The AN5116-06B supports the following three triple play solutions:

- ◆ EPON / 10G EPON triple play solution

The EPON / 10G EPON ONU uses different VLANs to classify different service flows which are mapped to the same LLID and transported to the AN5116-06B via the EPON / 10G EPON line.

◆ GPON single GEM port triple play solution

Supports classifying service flows based on Ethernet type, VLAN ID of subscriber side messages and subscriber side 802.1p domain, and supports control of service flows.

◆ GPON multiple GEM port triple play solution

Classifies different service flows by different GEM ports, maps different services to different GEM ports according to the VLAN ID, 802.1p, or physical port, and then delivers them to the AN5116-06B via the GPON line for processing.

The AN5116-06B can provide subscribers simultaneously with multimedia services such as data, voice and video services, and provide QoS guarantees accordingly.

See Figure 2-2 for an illustration of the triple play network.

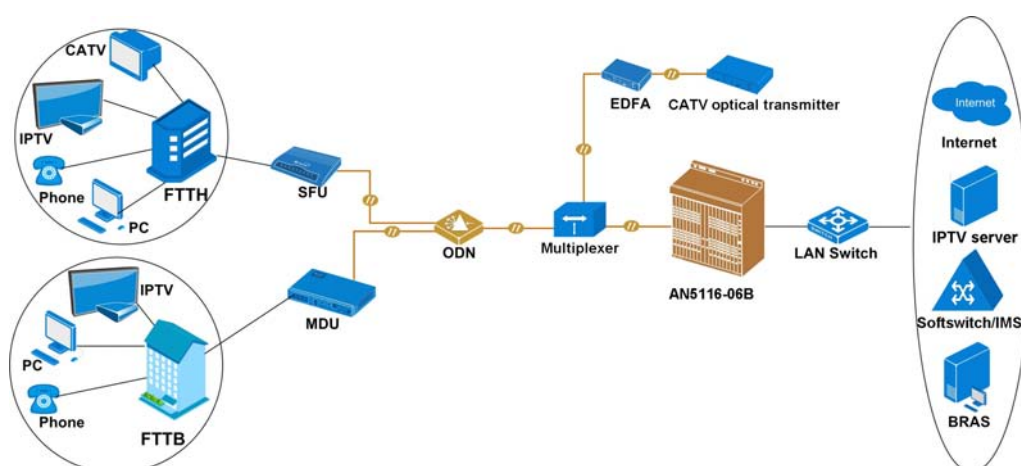

Figure 2-2 The Triple Play Application of the AN5116-06B

## 2.2.2 MSTP Service Application

The MSTP is compatible with the STP and RSTP functions, and improves the two technologies. The MSTP can implement fast convergence, and also can provide better load sharing function for the redundancy link, and is applicable in the network needing the service protection. But it is not recommended that users use the MSTP at modes supporting many subscribers.

The AN5116-06B supports the MSTP service application. The MSTP divides a Layer 2 network into multiple domains, and multiple independent spanning trees are generated in each domain, so as to eliminate the loops. In addition, the MSTP introduces the multi-instance technology. It maps each VLAN into the corresponding instance, so as to share the traffic load between different VLANs. See Figure 2-3 for the network of the MSTP service application.

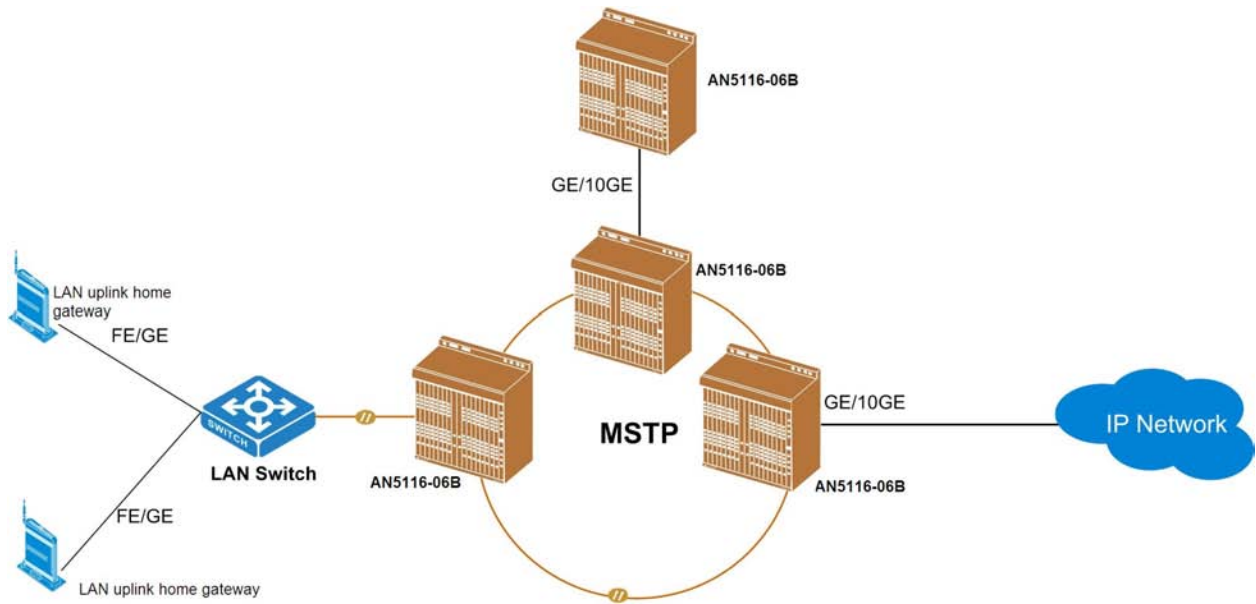

Figure 2-3 Network of the AN5116-06B in MSTP Service

### 2.2.3 TDM Service Application

The AN5116-06B supports the TDM service application. It protects investment in traditional TDM network, and uses the CES technology to enable TDM over IP, so as to achieve the all-IP network architecture.

The AN5116-06B supports both asynchronous and synchronous clock modes and provides a highly reliable transport solution for synchronization information and E1 services. See Figure 2-4 for the network of the TDM service application.



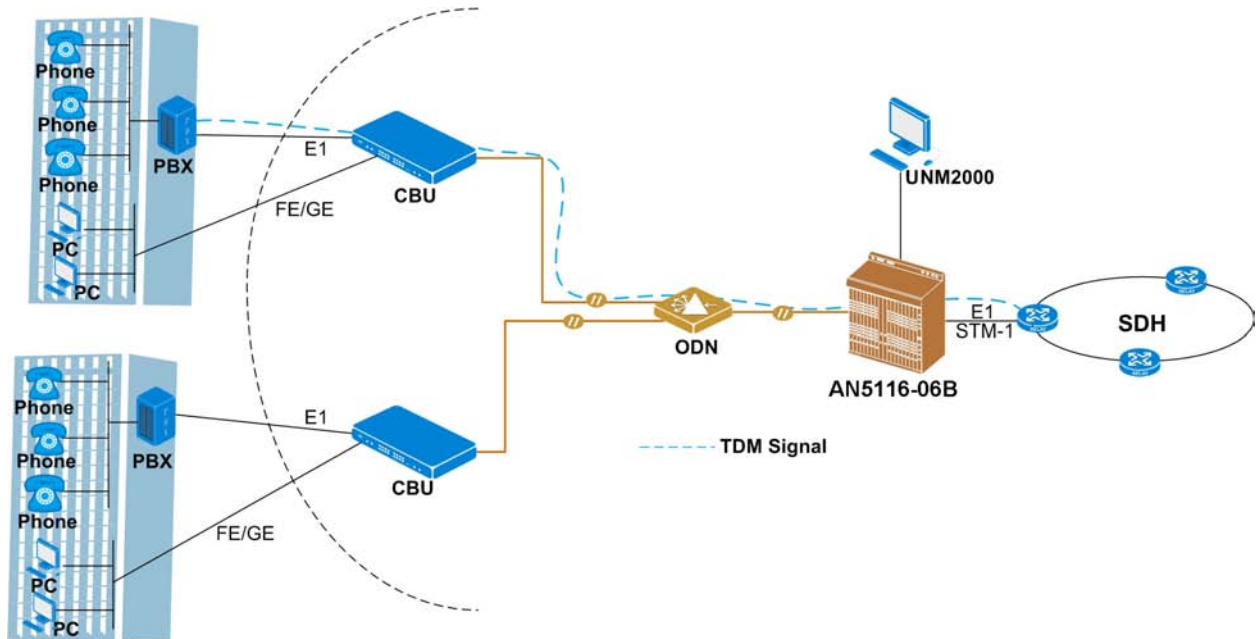

Figure 2-4 Network of the AN5116-06B in TDM Service

Through the E1 interface, the system can access the TDM services of the enterprise private line users, and the CBU transmits the data and TDM services to the OLT side at the same time. The OLT identifies and forwards the data and TDM services, and then transmits them to the SDH network at the upper level via the E1 / STM-1 interface.

## 2.2.4 Residence and Home Application

Along with the application of the FTTx technology in the intelligent residence and home, users can enjoy abundant network resources and excellent service quality without leaving their homes.

In the residence and home application, the AN5116-06B supports the LAN, SFU, or xDSL MDU. See Figure 2-5 for an illustration of the residence and home application.

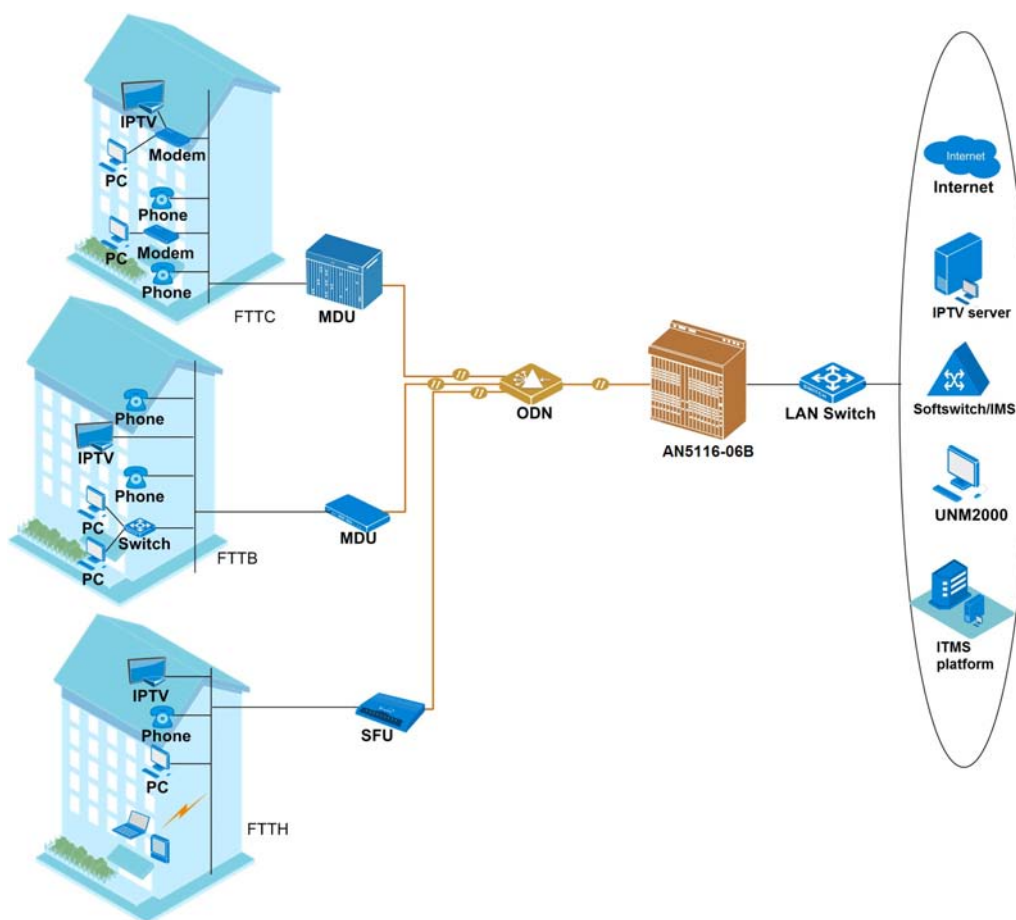

Figure 2-5 Application of the AN5116-06B in Residential Districts and Families

- ◆ For the application from the central office to the cub near the home or office, it is recommended that users use the FTTC access mode. In this mode, the services can be transmitted to the home or office from the curb, so as to provide subscribers with voice, data, and video services.
- ◆ For the application in the building that has been configured with the twisted-pair cables, it is recommended that users use the FTTB access mode. The fiber is accessed into the MDU equipment inside the building after it enters the building, and then the services are transmitted to various subscribers via the twisted-pair cables, so as to provide subscribers with voice, data, and video services inside the building.

- ◆ For the application in the relatively decentralized suburban environment, it is recommended that users use the FTTH access mode. In this mode, voice, data, and video services are provided through a single fiber for subscribers via the SFU equipment.

## 2.2.5 Small Cell Bearing Application

With the rapid popularization of the mobile intelligent terminals, the increasing mobile data services are laying a big pressure of traffic on the operators' macro cell network. It becomes an urgent problem to divide the traffic pressure by grading at different levels.

The application of the Small Cell can effectively share the traffic of the macro cell network. The data traffic is channelized inside the access network, and then sent back to the core network, which can largely save the network resources for 3G/4G transmission. Meanwhile, the Small Cell is small-sized and can be applied in various scenarios conveniently. Operators can use it as the platform for many customized services (such as message pushing and hot spot covering services) to form a new profit-making point.

Figure 2-6 shows the bearer network of Small Cell.

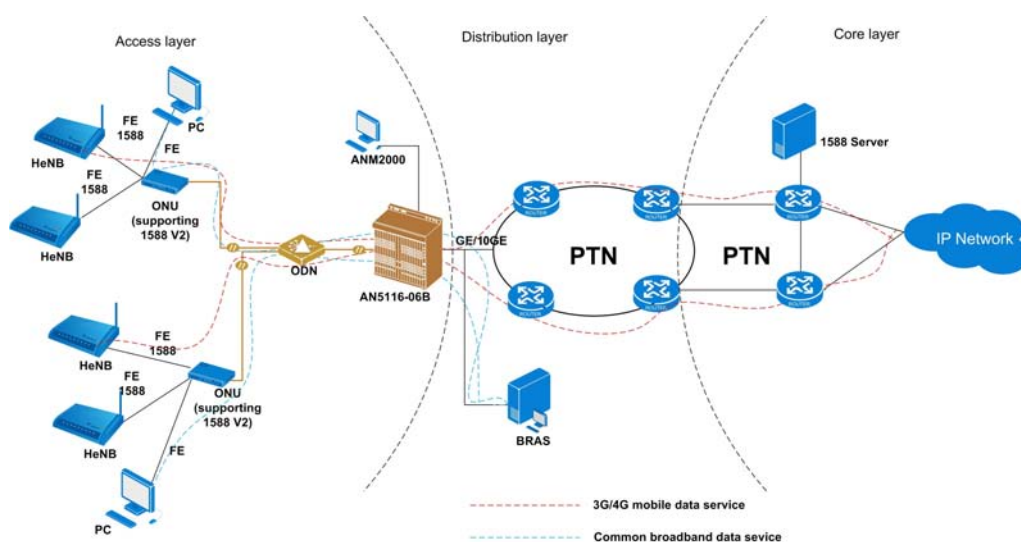

Figure 2-6 Application of the AN5116-06B in the Small Cell

By setting VLANs, the AN5116-06B can access the common broadband data service and the 3G / 4G mobile data service at the same time. This improves the network capacity and covering capability, so as to bear the mobile data service better.

The AN5116-06B supports the BC mode of the 1588 V2 clock model. It is used together with the ONU supporting the 1588 V2 protocol to provide the clock information for the Small Cell to ensure a high-precision clock frequency and phase synchronization and finally ensure the clock synchronization between the terminal equipment and the AN5116-06B.

## **2.2.6 High Bandwidth Access Application**

Along with the development of the Triple Play application, the EPON / GPON technology has been quite mature and is now widely used in the network construction and project improvement of operators. However, users have increasing demands on application of various high bandwidth value-added services. It becomes the new orientation for the development of the FTTx technology to access more subscribers and guarantee higher bandwidth.

The AN5116-06B supports the 10G EPON interface card. The 10G EPON interface card provides eight EPON interfaces complaint with the IEEE 802.3av/802.3ah standard. Each EPON interface supports a transmission distance of at least 20 km, and supports a maximum split ratio of 1:128 within the optical power budget. It can be applied in the broadband data convergence in the MAN. By accessing the 10G EPON ONU, the equipment provides the FE / GE interface to solve the problem of limited optical fiber resource in the network construction.

The 10G EPON technology of the AN5116-06B can be widely used in the construction of the campus network or the enterprise network. Here we take the campus network as an example, as shown in Figure 2-7.

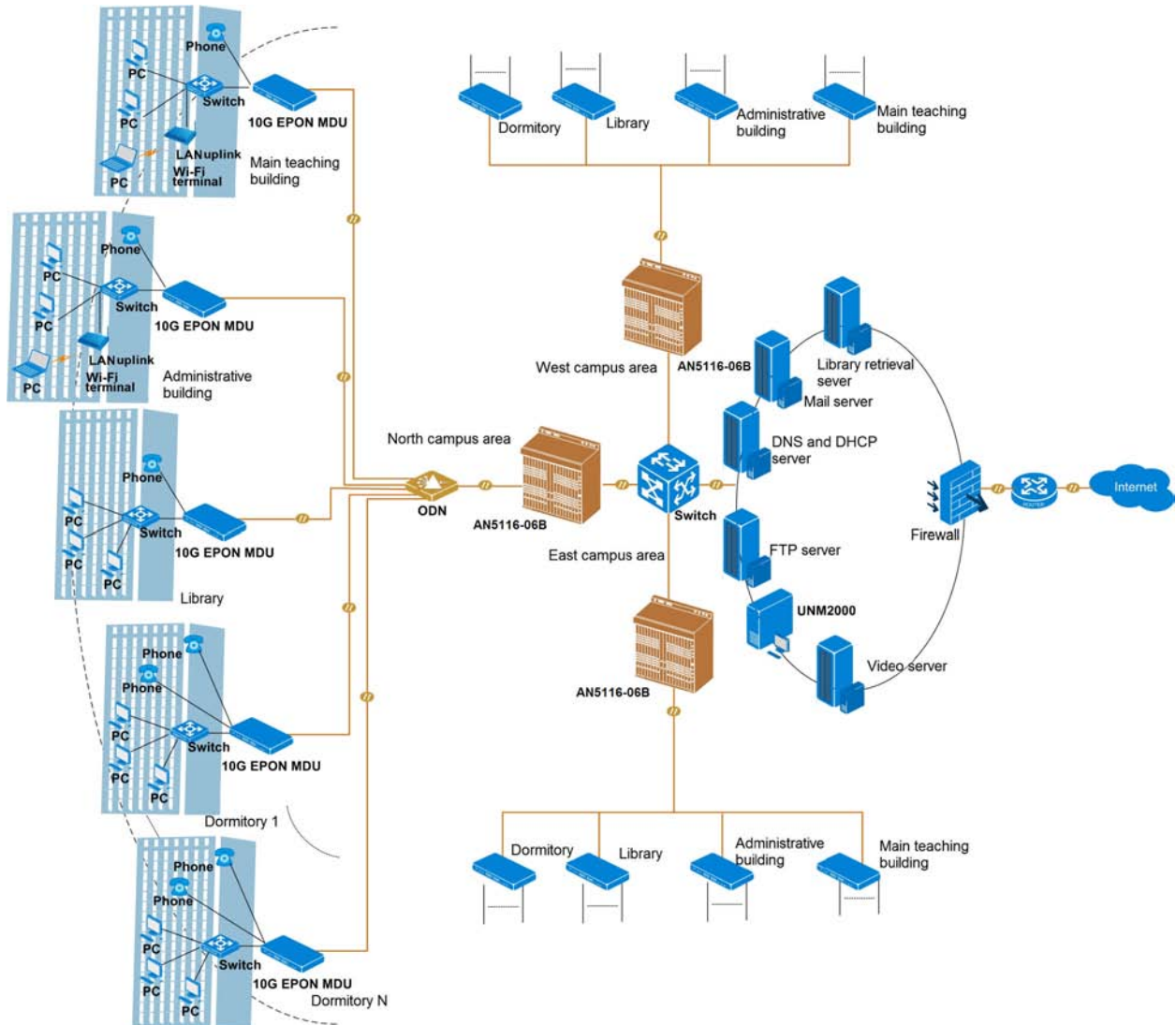

Figure 2-7 Application of the AN5116-06B in High Bandwidth Access

It is recommended that you use the AN5006-07 / 09 / 10, the AN5506-07 / 09 / 10, or the AN5200-07 / 10 as the ONU, which can provide 24 voice and data interfaces at most.

## 2.2.7 Wi-Fi Hot Spot Covering Application

The equipment provides the power supply for the Wi-Fi equipment and monitoring equipment in some special circumstances via the PoE ONU, so as to solve the problem of power supply difficulties in places such as the department stores, communities and fields, where it is hard to arrange the Wi-Fi equipment. Compared with the traditional local power supply mode, the equipment provides a power supply measure which is cheap, flexible in deployment, and reliable. This can speed up the progress of network construction, and enable rapid deployment of services.

The equipment supports the PoE ONUs of various types, and can be applied as follows:

- ◆ By providing the power supply for the Wi-Fi equipment via the PoE ONU, covers the public areas such as the department stores and community, and supports the wireless access of the terminal devices such as the portable computer and the mobile phone.
- ◆ By providing the power supply for the monitoring equipment via the PoE ONU, implements the remote security monitoring. The collected monitoring data are transmitted to the monitoring center via the equipment.

See Figure 2-8 for the network of the Wi-Fi hot spot covering application.

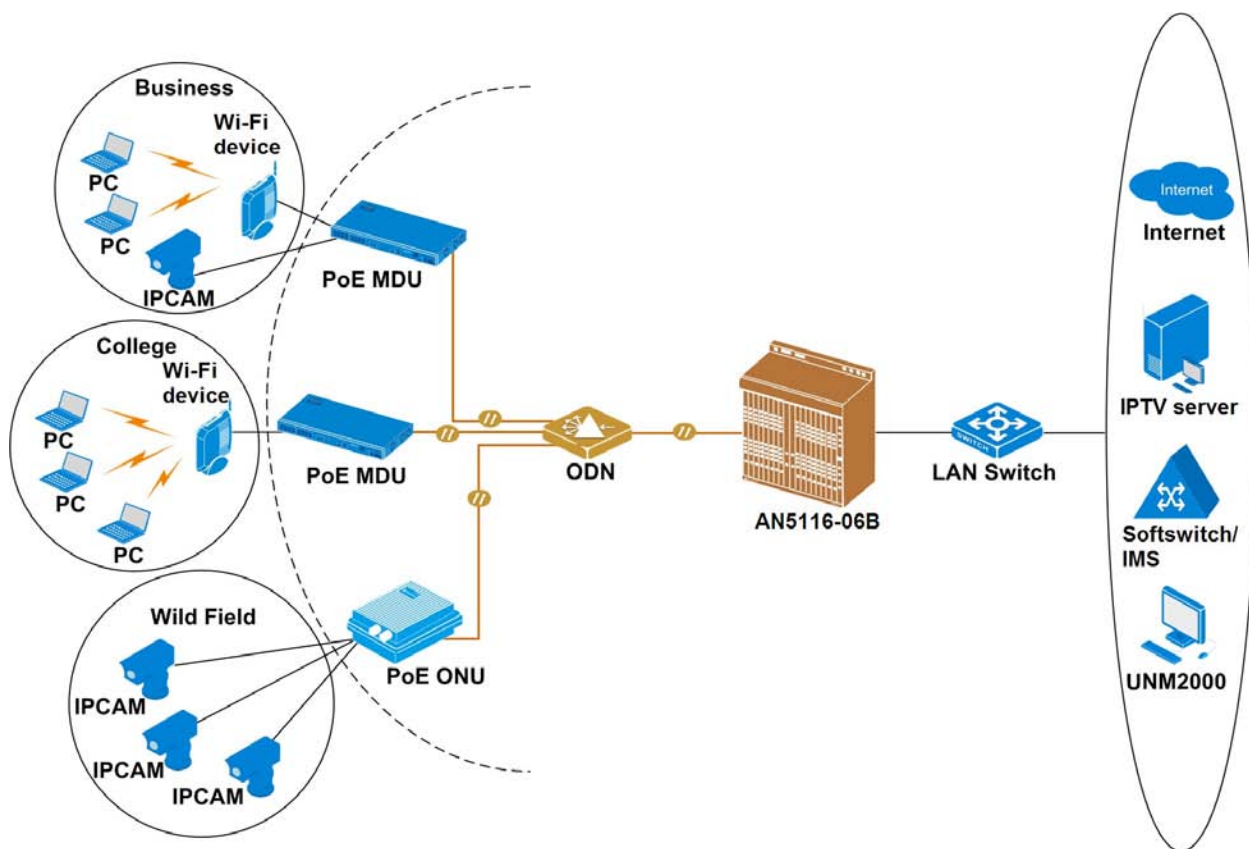

Figure 2-8 Application of the AN5116-06B in the Wi-Fi Hot Spot Covering

For different applications, the following PoE ONUs are recommended:

- ◆ For indoor applications, the PoE MDU AN5006-07-AK / AN5006-09-AK / AN5006-10-AK or AN5506-07-A1K / AN5506-09-A1K / AN5506-10-A1K is recommended.
- ◆ For outdoor applications, the PoE ONU AN5506-02-AKW is recommended.





# 3 Product Composition

---

The following introduces the logical architecture, hardware structure, and software architecture of the AN5116-06B.

- Logical Architecture
- Hardware Structure
- Software Architecture

### 3.1 Logical Architecture

The AN5116-06B takes full-10GE switching and IP packets as its core. The core switch card is connected to various service cards via a high-speed interconnection bus. The core switch card aggregates data from the service cards and forwards them to the uplink card or TDM cards for transmission to the providers network. See Figure 3-1.

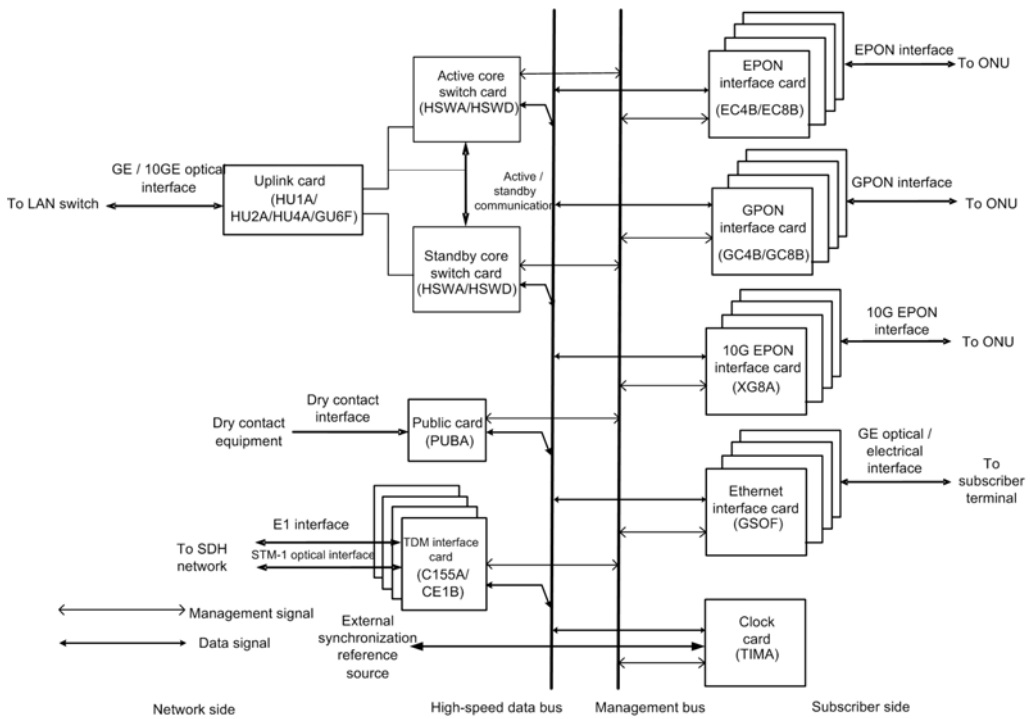

Figure 3-1 Logical Architecture of the AN5116-06B



**Note:**

The HU4A card can be used only when the equipment is configured with the HSWD card.

- ◆ The left side of the figure shows the network side of the AN5116-06B. On this side, the uplink cards or TDM interface cards transmit service signals to various transmission networks.

- ◆ The right side of the figure shows the subscriber side of the AN5116-06B. On this side, the EPON / GPON / 10G EPON interface cards connect with the ONUs via the ODN; and the Ethernet interface cards connect with the subscriber or other Ethernet equipment sets via the cascade interfaces.
- ◆ The core switch cards manage other cards through the management bus.

## **3.2 Hardware Structure**

The following introduces the hardware structure of the cabinet, PDP, subrack and cards.

### **3.2.1 19-inch Cabinet**

The following introduces the 19-inch cabinet used by the AN5116-06B.

#### **3.2.1.1 Appearance**

See Figure 3-2 for the appearance of the 19-inch cabinet.



Figure 3-2 Appearance of a 19-inch Cabinet

### **3.2.1.2 Dimension**

The dimensions of a 19-inch cabinet are described as follows in terms of Height (H) × Width (W) × Depth (D):

- ◆ 1600mm×600mm×600mm
- ◆ 2000mm×600mm×600mm
- ◆ 2200mm×600mm×600mm
- ◆ 2600mm×600mm×600mm

### 3.2.1.3 Equipment Layout

According to their heights, the 19-inch cabinets can be classified into four types: 2600 mm cabinet, 2200 mm cabinet, 2000 mm cabinet, and 1600 mm cabinet. See Figure 3-3 for the typical configurations of them respectively (unit: mm).

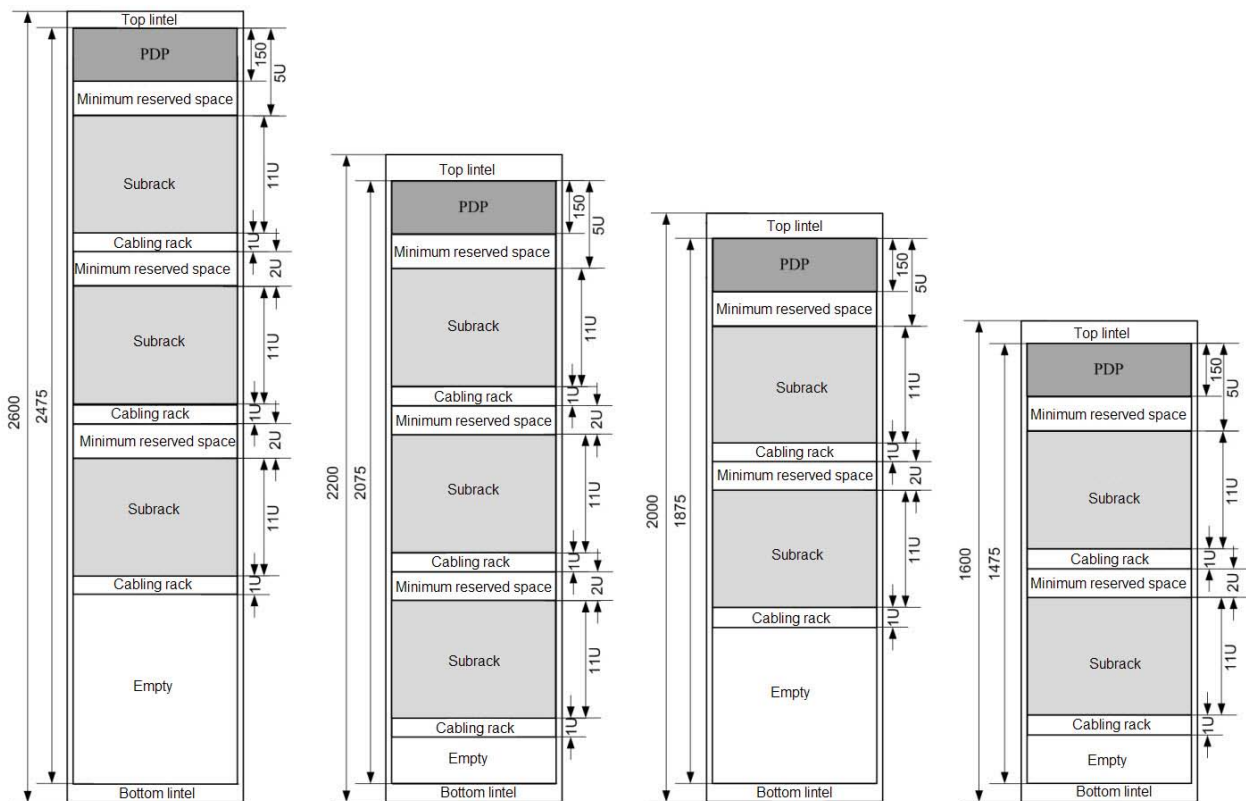

Figure 3-3 Typical Layout of a 19-inch Cabinet



#### Note:

If a cabinet is not fully configured, users should arrange the subracks from the top down and reserve the space in the lower part for capacity expansion in the future.

### 3.2.2 21-inch Cabinet (without the Anti-dust Screen)

The following introduces the 21-inch cabinet (without the anti-dust screen) used by the AN5116-06B.

### 3.2.2.1 Appearance

The appearance of a 21-inch cabinet (without the anti-dust screen) is shown in Figure 3-4.



Figure 3-4 Appearance of a 21-inch Cabinet (without the Anti-dust Screen)

### 3.2.2.2 Dimensions

The dimensions of 19-inch cabinets are described as follows in terms of Height (H) × Width (W) × Depth (D):

- ◆ 1600mm × 600 mm × 300mm
- ◆ 2000 mm × 600 mm × 300mm
- ◆ 2200mm × 600 mm × 300mm
- ◆ 2600mm × 600 mm × 300mm

### 3.2.2.3 Equipment Layout

According to their heights, the 21-inch cabinets (without the anti-dust screen) can be classified into four types: 2600mm cabinet, 2200mm cabinet, 2000mm cabinet, and 1600mm cabinet. The corresponding typical configurations of these cabinets are shown in Figure 3-5 (unit: mm).

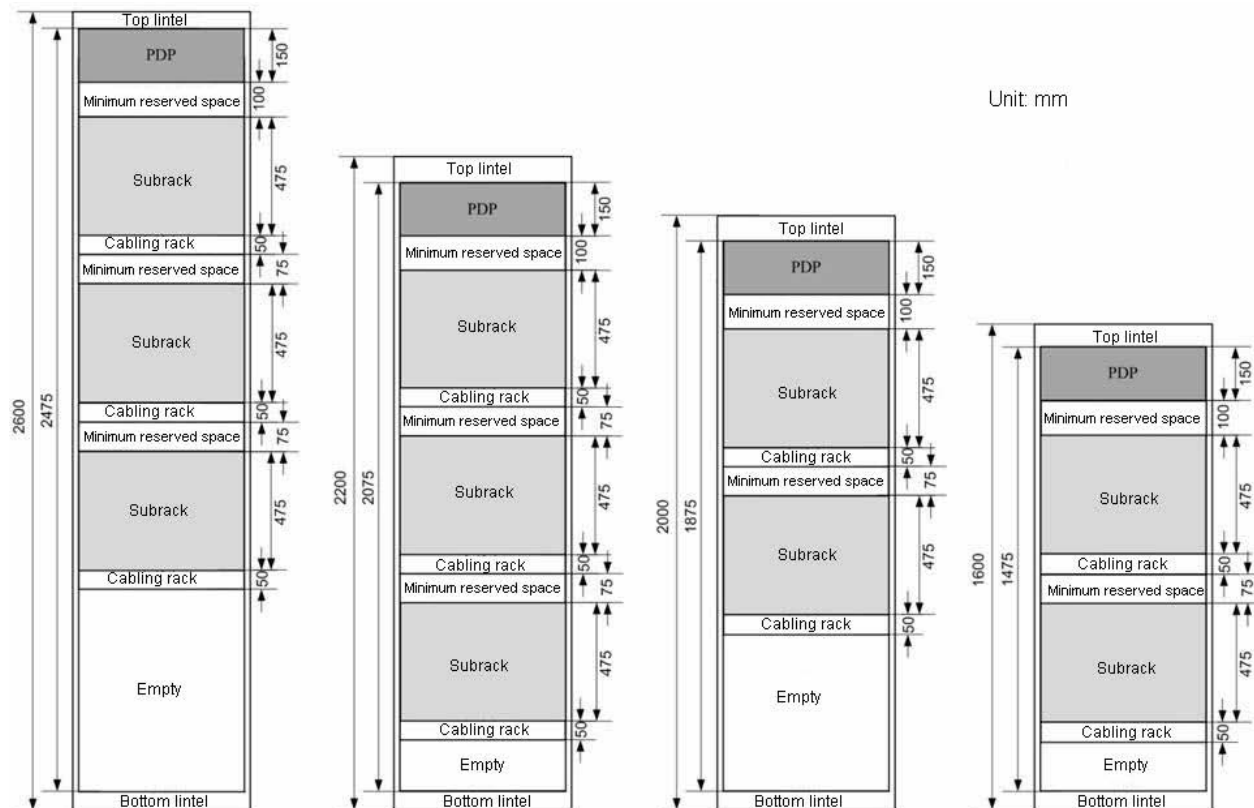

Figure 3-5 Typical Layout of a 21-inch Cabinet (without the Anti-dust Screen)



#### Note:

If a cabinet is not fully configured, users should arrange the subracks from the top down and reserve the space in the lower part for capacity expansion in the future.

### **3.2.3 21-inch Cabinet (with the Anti-dust Screen)**

The following introduces the 21-inch cabinet (with the anti-dust screen) used by the AN5116-06B. The anti-dust screen has been installed at the air inlets of the cabinet (such as the front door and top) before delivery.

#### **3.2.3.1 Appearance**

The appearance of a 21-inch cabinet (with the anti-dust screen) is shown in Figure 3-6.



Figure 3-6 Appearance of a 21-inch Cabinet (with the Anti-dust Screen)



### 3.2.3.2 Dimension

The dimensions of a 21-inch cabinet (with the anti-dust screen) are described as follows in terms of Height (H) × Width (W) × Depth (D):

- ◆ 1600mm×600mm×300mm
- ◆ 2000mm×600mm×300mm
- ◆ 2200mm×600mm×300mm
- ◆ 2600mm×600mm×300mm

### 3.2.3.3 Equipment Layout

According to their heights, the 21-inch cabinets (with the anti-dust screen) can be classified into four types: 2600mm cabinet, 2200mm cabinet, 2000mm cabinet, and 1600mm cabinet. The corresponding typical configurations of these cabinets are shown in Figure 3-7 (unit: mm).

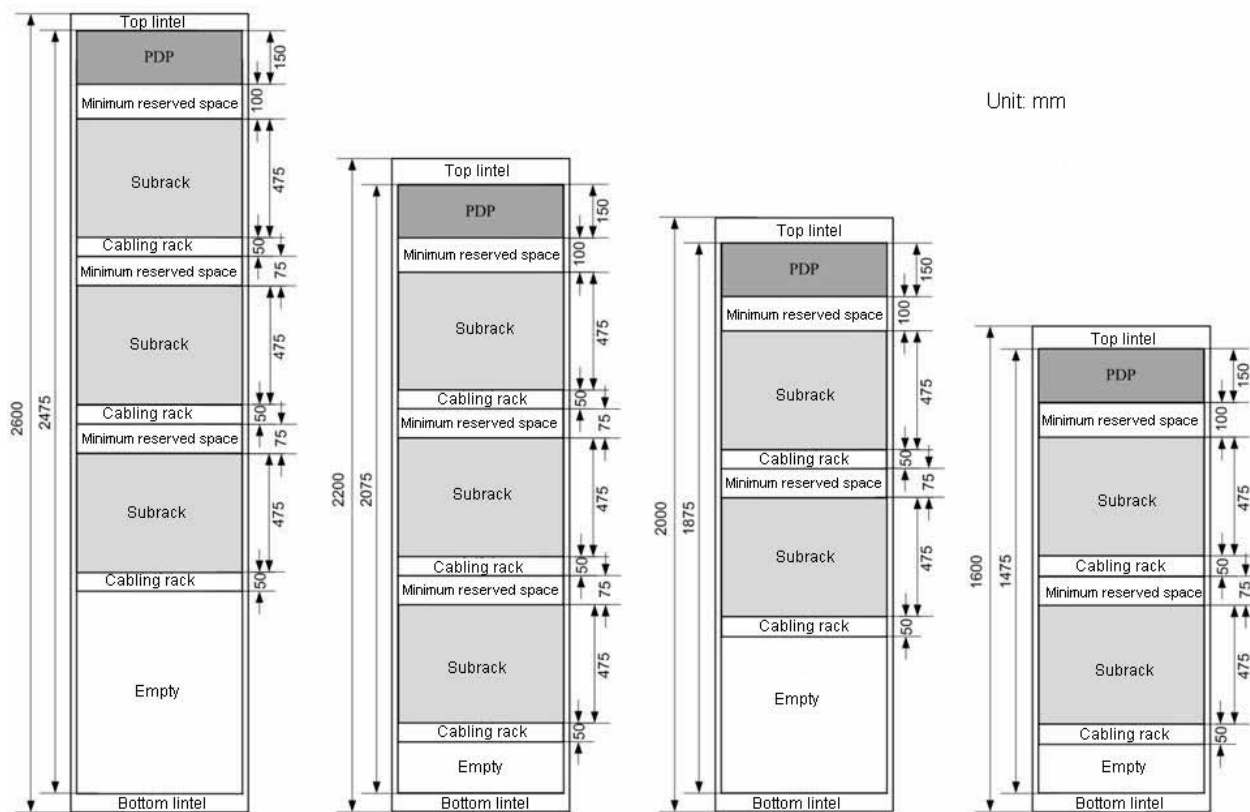

Figure 3-7 Typical Layout of a 21-inch Cabinet (with the Anti-dust Screen)



Note:

If a cabinet is not fully configured, users should arrange the subracks from the top down and reserve the space in the lower part for capacity expansion in the future.

---

## 3.2.4 PDP

The AN5116-06B uses the PDP of the following types for the corresponding cabinets to provide eight branches of power supply (four active and four standby) for the equipment.

- ◆ For a 19-inch cabinet, the PDP 3000064-1FHR1AA is used.
- ◆ For a 21-inch cabinet, the PDP 3000064-2FHR1AA is used.

### 3.2.4.1 Function

The PDP is used to perform the following functions:

- ◆ Power distribution function: Inducts eight channels of DC -48 V power (active and standby) from the external (e.g. the power cabinet) and provides four sets of redundant branch power rails (eight branch power rails in total). The maximum output current of a single channel is 50 A.
- ◆ Alarm signal processing function: The PDP collects the alarm information from the corresponding equipment via the four alarm convergence connectors, provides corresponding audible alarm signals, illuminates the cabinet top indicator LEDs, and outputs the alarm signals to higher-level equipment (such as the head of row cabinet).
- ◆ Lightning protection module alarm reporting function: When the lightning protection module fails, the PDP outputs the lightning protection failure alarm, and then reports it to the network management system via the equipment.
- ◆ Lightning protection function: The PDP can effectively withstand surge current of common mode 4kV / differential mode 2kV (1.2/50 us to 8/20 us hybrid wave) on the power line.

### 3.2.4.2 Appearance

See Figure 3-8 for the appearance of the PDP.



Figure 3-8 Appearance of the PDP

### 3.2.5 Subrack

The following introduces the appearance, structure, and layout of the subrack.

#### 3.2.5.1 Appearance

The backplane of the AN5116-06B is located in the rear of the subrack. All cards of the equipment are plugged from the front of the subrack and the front wiring mode is used. Figure 3-9 shows the structure and components of the subrack.

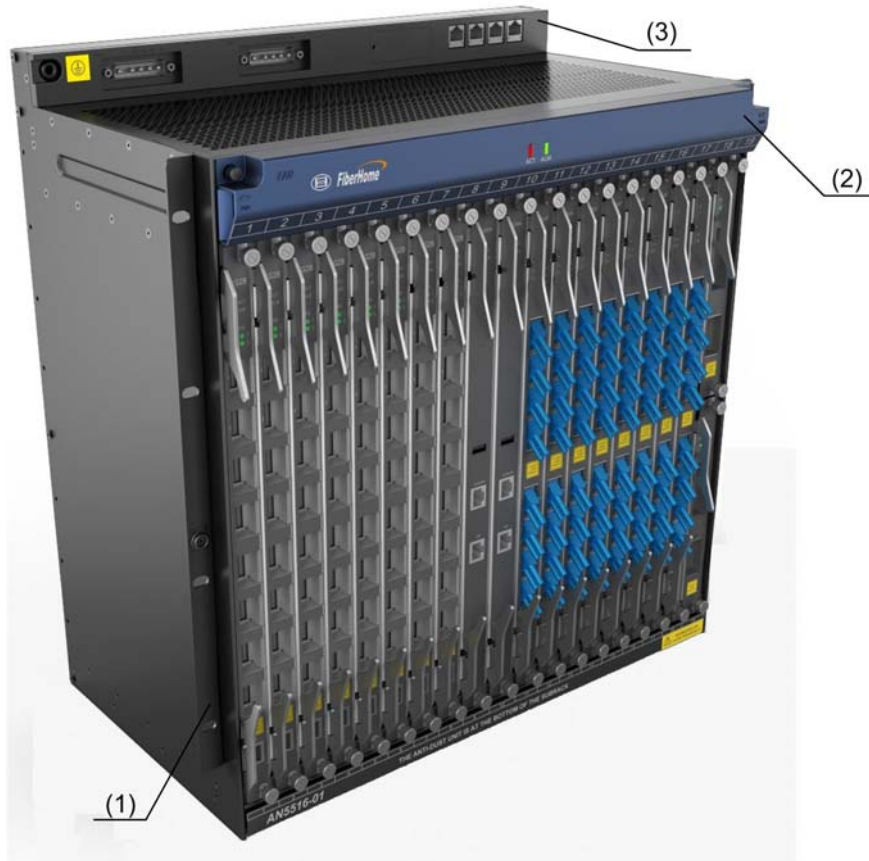

(1) Mounting ear                      (2) Fan unit                      (3) Backplane

Figure 3-9 Subrack Structure

See Table 3-1 for description of each component of the subrack.

Table 3-1 Description of Subrack Structure

Number	Description	Function
(1)	Mounting ear	Secures the subrack in a 19-inch cabinet.
(2)	Fan unit	Facilitates air cooling for the equipment.
(3)	Backplane	Connects each module and performs the function of bus.

### 3.2.5.2 Slot Allocation and Typical Configuration

See Figure 3-10 for the slot allocation and typical configuration of the AN5116-06B subrack.

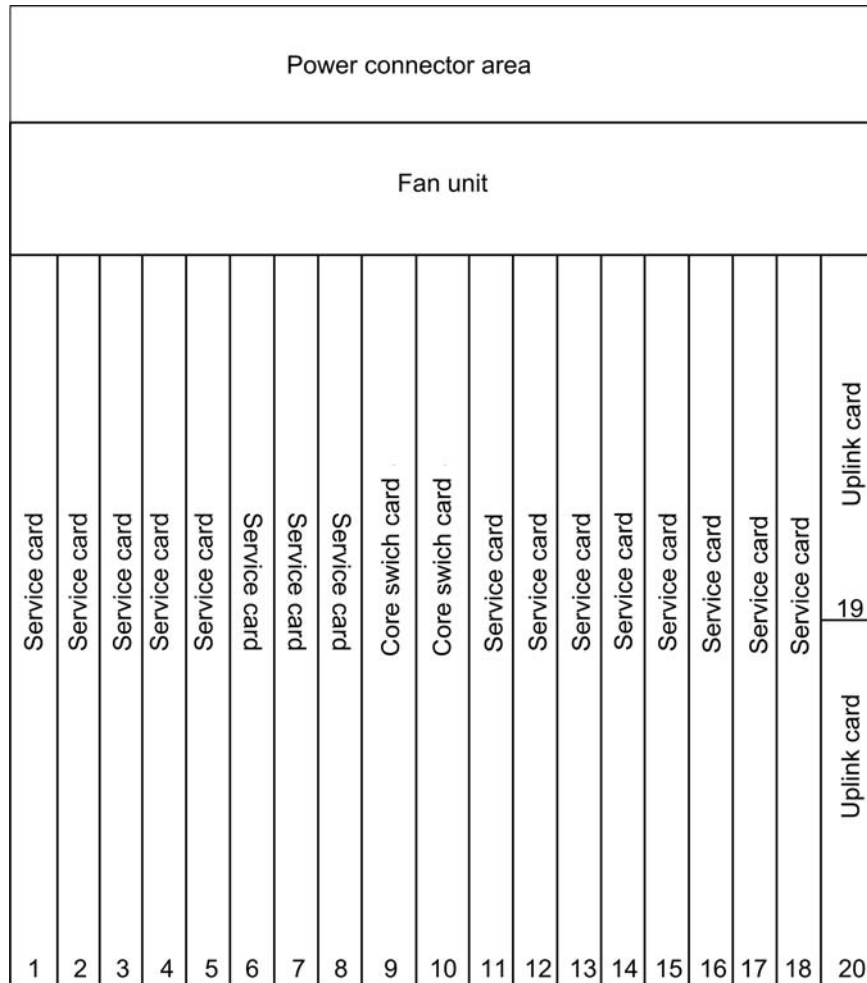

Figure 3-10 Subrack Slot Allocation and Typical Configuration

The AN5116-06B subrack has a total of 20 vertical slots.

- ◆ Slots 1 to 8 and 11 to 18 are for various service cards such as EPON interface cards, 10G EPON interface cards, GPON interface cards, TDM interface cards, and Ethernet interface cards.
- ◆ Slots 9 and 10 are slightly wider and are for core switch cards.
- ◆ Slots 19 and 20 are on the rightmost part of the subrack. Half as high as other slots, the two slots are designed for uplink cards.

## 3.2.6 Card

The AN5116-06B card functions are shown in Table 3-2 .

Table 3-2 Card Function List

Card Type	Card Name	Function Description
Uplink card	HU1A	Uplinks the signals in the EPON / GPON system; provides four GE uplink optical / electrical interfaces and one 10GE uplink optical interface.
	HU1B	Uplinks the signals in the EPON / GPON system and enables Ethernet clock synchronization; provides four GE uplink optical / electrical interfaces and one 10GE uplink optical interface.
	HU2A	Uplinks the signals in the EPON / GPON system; provides two GE uplink optical / electrical interfaces and two 10GE uplink optical interfaces.
	GU6F	Uplinks the signals in the EPON / GPON system; provides six GE uplink optical / electrical interfaces.
	GU6B	Uplinks the signals in the EPON / GPON system and enables Ethernet clock synchronization; provides six GE uplink optical / electrical interfaces.
	HU4A	Uplinks the signals in the EPON / GPON system; provides four 10GE / GE uplink optical interfaces.
EPON interface card	EC4B	Accesses subscriber services; provides four EPON service interfaces. Supports the split ratio up to 1:64 within the limits of the optical power budget.
	EC8B	Accesses subscriber services; provides eight EPON service interfaces. Supports the split ratio up to 1:64 within the limits of the optical power budget.
	ECOB	Accesses subscriber services; provides 16 EPON service interfaces. Supports the split ratio up to 1:64 within the limits of the optical power budget.
10G EPON interface card	XG8A	Accesses subscriber services; provides eight 10G EPON service interfaces. Supports the split ratio up to 1:128 within the limits of the optical power budget.
GPON interface card	GC4B	Accesses subscriber services; provides four GPON service interfaces. Supports the split ratio up to 1:128 within the limits of the optical power budget.

Table 3-2 Card Function List (Continued)

Card Type	Card Name	Function Description
	GC8B	Accesses subscriber services; provides eight GPON service interfaces. Supports the split ratio up to 1:128 within the limits of the optical power budget.
	GCOB	Accesses subscriber services; provides 16 GPON service interfaces. Supports the split ratio up to 1:128 within the limits of the optical power budget.
TDM interface card	CE1B	Uplinks the TDM service signals; supports uplinking of 32 E1 signals.
	C155A	Uplinks the TDM service signals; supports uplinking of one STM-1 signal.
Ethernet interface card	GSOF	Uplinks or cascades the Ethernet service signals; provides 16 GE optical / electrical interfaces.
Clock card	TIMA	Inputs and outputs various clock synchronization signals, including input and output of one 1PPS+TOD signal, input of one 1588V2 signal, input of two BITS clock signals and output of one BITS clock signal.
Core switch card	HSWA	Aggregates, switches and manages service flows in the EPON / GPON / 10G EPON system; processes Layer 2 and Layer 3 protocols; provides fault management, configuration management, and performance management for the equipment. Provides a Console interface for local management.
	HSWD	Aggregates, switches and manages service flows in the EPON / GPON / 10G EPON system; processes Layer 2 and Layer 3 protocols; provides fault management, configuration management, and performance management for the equipment. Supports large capacity data exchange. Provides a Console interface for local management.

### 3.3 Software Architecture

The AN5116-06B's software module is composed of the core switch software, the service interface card software, the uplink card software, and the network management software. See Figure 3-11.

- ◆ The core switch software resides on the core switch card. It manages and maintains the AN5116-06B, and provides the management and maintenance interface for the network management system. It is the core of the software system.
- ◆ The service interface card software resides on various service interface cards and communicates with the core switch software via the backplane bus.
- ◆ The uplink card software resides on the uplink card. It collects the information such as the uplink card type and the port operating status, and reports the related information to the core switch card. The uplink card software communicates with the core switch software via a serial port bus on the backplane.
- ◆ The network management software resides on the network management server. It provides the GUI for users. The network management software communicates with the core switch software based on the SNMP protocol.

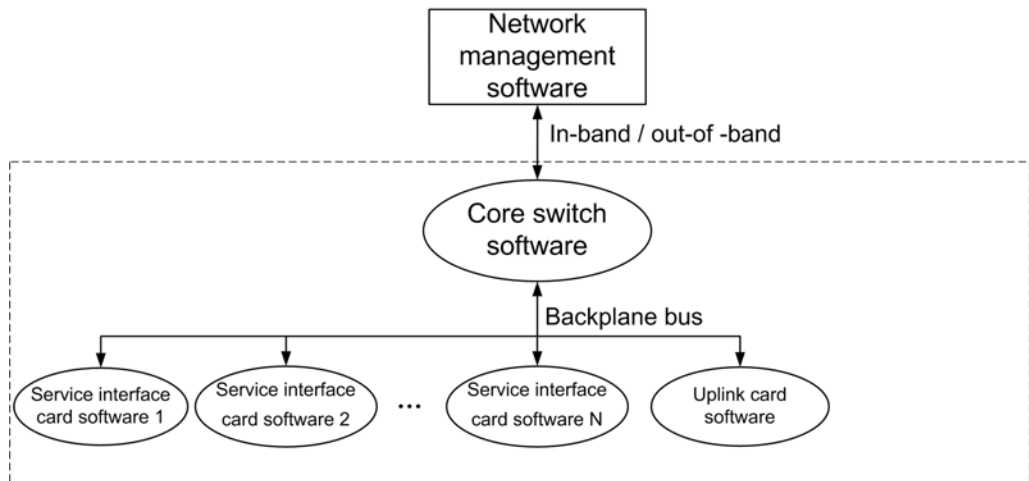

Figure 3-11 Software Architecture of the AN5116-06B System



# 4 System Management

---

The following introduces the system management mode of the AN5116-06B.

- Management Mode
- CLI Network Management System
- The UNM2000

## 4.1 Management Mode

The AN5116-06B supports various management modes for equipment maintenance and monitoring, and includes the following modes:

- ◆ According to whether the network management system is connected with the equipment network interface, the management modes can be classified as follows.
  - ▶ In the local management mode, the network management system computer is directly connected with the managed equipment via its network management interface, so as to manage the equipment. The HSWA / HSWD card's Console port is the port used in the local management mode.
  - ▶ In the remote management mode, the network management system computer is connected with the equipment via the LAN or the Internet, so as to manage the equipment. The GE or 10GE interfaces or the EMS out-of-band network interface of the uplink card are the Telnet remote management interfaces.
- ◆ According to whether the management path and the service path are isolated physically, the management modes can be classified as follows.
  - ▶ In the out-of-band mode, the management information is transported via an independent physical path and does not use the subscriber service path.
  - ▶ In the in-band mode, the management information is transported via the subscriber service path provided by the managed equipment.
- ◆ According to whether the management system uses a GUI, the management modes can be classified as follows.
  - ▶ The GUI mode provides GUIs for operators. It is easy to understand and operate.
  - ▶ The CLI mode uses the CLI. This may be too complex for the casual or occasional operators.

## 4.2 CLI Network Management System

Operators can log in the CLI management system for the in one of the two ways as mentioned below:

- ◆ Log in the AN5116-06B system via the Console interface using a hyper terminal.
- ◆ Log in the AN5116-06B system via the uplink interface or the out-of-band network port in the Telnet mode.

Figure 4-1 illustrates the network diagram for logging in the CLI network management system.

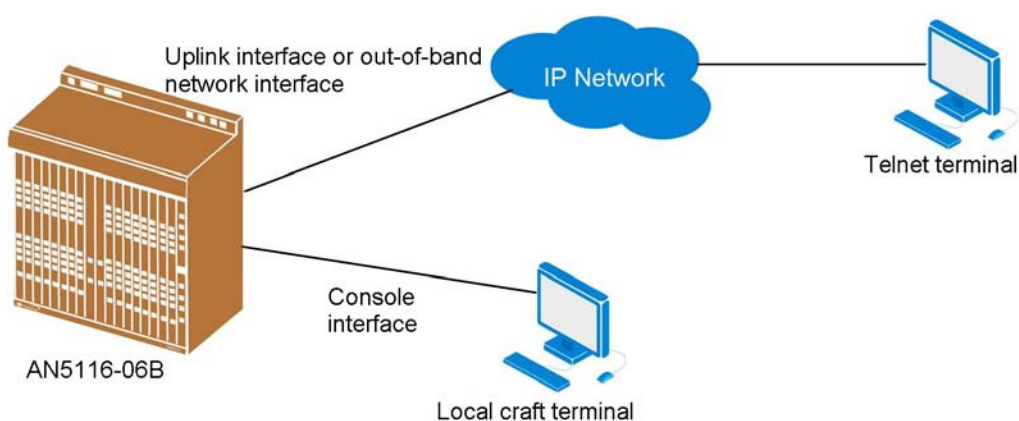

Figure 4-1 Network Diagram for the CLI Network Management System

## 4.3 The UNM2000

Compared with its predecessor, the UNM2000 has enhanced management capability, extensibility and practicability to serve as a new generation of customer-centered and future-oriented network management system. The features of the UNM2000 are described as follows:

- ◆ The UNM2000 has its management capability improved by using the distributed deployment. It controls the management module flexibly using the License function.
- ◆ Using the industry-leading retractable modularized architecture, the UNM2000 supports the distribution and hierarchy of the database module, service configuration module and common module.

- ◆ As a new generation of network management system, the UNM2000 aims to provide users with customer-centered experience.
- ◆ As an independent application program, the UNM2000 can be installed in various operating systems based on different databases. That is, it is compatible with multiple operating systems.
- ◆ The UNM2000 can provide both superior solutions for large-scale networks and low-cost solutions for small and medium-sized networks.
- ◆ The UNM2000 can be run on the Windows, Linux and Solaris operating systems. The performance of the client end and server end of the UNM2000 is irrelevant to the operating system used.

### **4.3.1 Function**

#### Configuration Management

The UNM2000 manages the configurations of all the equipment in the network, and users can configure various items for the equipment via the UNM2000. The UNM2000 provides a universal configuration GUI for all services. Users can configure various services such as data, voice, IPTV and CATV services collectively on the UNM2000, which greatly enhances the efficiency of configuration.

#### Topology Management

In the topology management, the state of connection between the managed NEs is displayed in form of topograph, and users can learn about the network condition of the entire network in a real time manner and monitor the operation state by viewing the topology view.

#### Alarm Management

The system can monitor the faults and abnormalities that occur during the operation of the equipment in a real time manner using the alarm management function. Meanwhile, it provides detailed information about the alarms and analyzing measures to assistant in fault isolation and troubleshooting.

## Event Management

Events occur during the normal operation of the system, and they act as active notices to users. The UNM2000 divides the events into four levels based on the order of severity: urgent, major, minor and prompt.

## Performance Management

The UNM2000 supports viewing the real-time performance data and comprehensive management performance data. It can monitor the real-time performance of relevant equipment in the access network and compare the instant performance, which helps users to learn of the current operation state and basic performance of the network, prevent network accidents and plan the operation network appropriately.

## Security Management

The purpose of security management is to prevent illegal users from logging in the network management system and prevent legal users from operating the network management system beyond their authorization, so as to guarantee the safe operation of the network. The UNM2000 provides a sound security management mechanism to guarantee the network security by means of authorization and domain division, access control, log management, and so on.

## 4.3.2 Operating Environment

### Server End

The hardware configuration requirements for the UNM2000 server varies with the network scale. See Table 4-1 for the details.

Table 4-1 Hardware Configuration Requirement for the Server End

Network Scale	CPU Clock Rate	CPU Quantity	Memory Size	Hard Disk Space
Equivalent to more than 1000 OLTs, with fully-configured ONUs under them.	Intel E7-8837 (8-core), 2.6GHZ	4	64G	4*600GB
Equivalent to 500 to 1000 OLTs, with fully-configured ONUs under them.	Intel XeonE7-4610V2 (8-core), 2.3GHZ	4	32G	4*600GB

Table 4-1 Hardware Configuration Requirement for the Server End (Continued)

Network Scale	CPU Clock Rate	CPU Quantity	Memory Size	Hard Disk Space
Equivalent to 100 to 500 OLTs, with fully-configured ONUs under them.	Intel XeonE5-2667V2 (8-core), 3.3GHZ	2	32G	2*600GB
Equivalent to less than 100 OLTs, with fully-configured ONUs under them.	Intel XeonE5-2430V2 (6-core) 2.5GHz	2	16G	2*600GB

Table 4-2 lists the software requirements for the network management system server computer.

Table 4-2 Software Configuration Requirements for the Server End

Configuration Item	Requirement
Operating System	Windows Server 2008 R2 Standard 64-bit
	Linux Enterprise11 64-bit
	Solaris 11 64-bit
Database	SQL Server 2008 R2
JRE	JRE 1.6.0

## Client End

Table 4-3 presents the hardware configuration requirements for the UNM2000 client end.

Table 4-3 Hardware Configuration Requirement for the Client End

Network Scale	CPU Clock Rate	CPU Quantity	Memory Size	Hard Disk Space
Equivalent to more than 1000 OLTs, with fully-configured ONUs under them.	Intel XeonE5-2637V2 (4-core), 3.5GHZ	1	8G	2*500GB
Equivalent to 500 to 1000 OLTs, with fully-configured ONUs under them.	Intel XeonE5-2637V2 (4-core), 3.5GHZ	1	8G	2*500GB

Table 4-3 Hardware Configuration Requirement for the Client End (Continued)

Network Scale	CPU Clock Rate	CPU Quantity	Memory Size	Hard Disk Space
Equivalent to 100 to 500 OLTs, with fully-configured ONUs under them.	Intel i3-4130 (dual-core) 3.4GHz	1	8G	1*500GB
Equivalent to less than 100 OLTs, with fully-configured ONUs under them.	Intel i3-4130 (dual-core), 3.4GHz	1	8G	1*500GB

Table 4-4 represents the software requirements for the computer to run the network management system client end.

Table 4-4 Software Configuration Requirement for the Client End

Configuration Item	Requirement
Operating System	Windows 7
JRE	JRE 1.6.0

### 4.3.3 Network Mode

#### In-band Mode

Under the in-band network mode, the management data and service data are transmitted via the same channel.

Advantage: The network is flexible, requiring no additional equipment, and has a relatively low cost.

Disadvantage: When a fault occurs in the network, the information channel leading to the managed network is interrupted, and you will be unable to do the maintenance work on the managed equipment via the UNM2000.

#### Out-of-band Mode

Under the out-of-band network mode, the management data and service data are transmitted via different channels.

Advantage: The management data channel is independent from the service data channel, and the management is not restricted by the state of the service data channel. Compared with the in-band mode, the out-of-band network mode can provide a more reliable equipment management channel. When a fault occurs in the managed equipment, the UNM2000 can identify the equipment information in a timely manner for real-time monitoring.

Disadvantage: Under the out-of-band network mode, an independent channel should be set up for the UNM2000 to manage the equipment in the network. The maintenance channel independent from the service channel should be provided. Accordingly, the network construction cost is relatively high.

### Network Example

The typical network mode for the UNM2000 is characterized by collective deployment with a single host. The UNM2000 is connected with the NEs in the out-of-band mode. See Figure 4-2 for the network diagram.

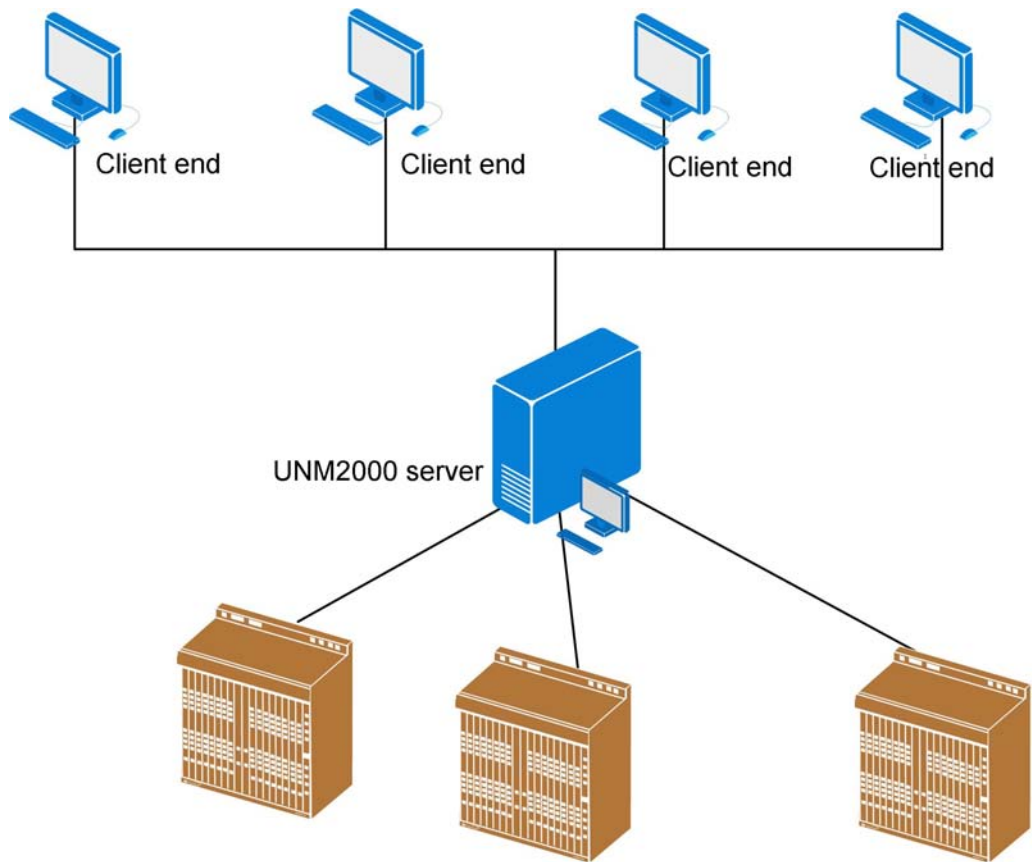

Figure 4-2 Network Example



# 5 Technical Specification and Standard

---

The following introduces the equipment's technical specifications and applicable standards.

- Performance Parameter
- Interface Specifications
- Mechanical Dimensions and Weight
- Power Supply and Power Consumption
- Equipment Room Requirement
- Standard and Protocol

## 5.1 Performance Parameter

The following introduces related performance parameters of the AN5116-06B.

### 5.1.1 Overall Performance

Table 5-1 The Overall Performance of the Equipment

Item	Specification
Core switch card capacity	408Gbit/s (equipped with the HSWA card) 960Gbit/s (equipped with the HSWD card)
Backplane bus capacity	5.12Tbit/s
Maximum transmission distance	20km
Maximum split ratio of EPON	1:64
Maximum split ratio of 10G EPON	1:128
Maximum split ratio of GPON	1:128
Core switch card active / standby switching time	< 50ms
Active/standby switching time for the uplink card	< 50ms
Optical protection switching time (TYPEB / TYPEC / TYPED)	< 50ms

Table 5-2 The DBA Performance of the Equipment

Item	Specification
Minimum bandwidth allocation granularity	≤256kbit/s
Minimum configurable bandwidth	≥512kbit/s
Accuracy	Better than ±5%

Table 5-3 The Ethernet Service Performance of the Equipment

Item	Specification	
Through-put	EPON system	Uplink throughput: ≥ 900 Mbit/s (the packet length is between 64-byte and 1518-byte; the split ratio is 1:32)
		Downlink throughput: ≥ 950 Mbit/s (any packet length)
	GPON system	Uplink throughput: ≥ 1100 Mbit/s
		Downlink throughput: ≥ 2400 Mbit/s

Table 5-3 The Ethernet Service Performance of the Equipment (Continued)

Item		Specification
	10G EPON system	When the 10G / 1G-EPON interface only accesses the 10G / 1G-EPON ONU, the downlink throughput is $\geq 8.3$ Gbit/s, and the uplink throughput is $\geq 900$ Mbit/s.
		When the 10G / 10G-EPON interface only accesses the 10G / 10G-EPON ONU, the downlink throughput is $\geq 8.3$ Gbit/s, and the uplink throughput is $\geq 8$ Gbit/s.
Latency	EPON / GPON system	The uplink mean transmission latency (when traffic flow is no more than 90% of the system throughput) is less than 1.5 ms under the split ratio of 1:32 (the packet length is between 64-byte and 1518-byte).
		The downlink mean transmission latency (when traffic flow is no more than 90% of the system throughput) is less than 1 ms (any packet length)
	10G EPON system	The uplink mean transmission latency (when traffic flow is no more than 90% of the PON interface throughput) is less than 1.5 ms under the split ratio of 1:32.
		The downlink mean transmission latency (when traffic flow is no more than 90% of the PON interface throughput) is less than 1 ms.
Packet loss rate	EPON / GPON system	The uplink packet loss rate under the split ratio 1:32 (the uplink and downlink traffic both being 1 Gbit/s) is less than 10% (any packet length).
		The downlink packet loss rate (the uplink and downlink traffic both being 1 Gbit/s) is less than 5% (any packet length).
	10G EPON system	When the 10G / 10G-EPON interface only accesses the 10G / 10G-EPON ONU under the split ratio 1:32 (the uplink and downlink traffic both being 10 Gbit/s), the PON interface uplink packet loss rate is less than 10%, and the PON interface downlink packet loss rate is less than 17%.
		When the 10G / 10G-EPON interface only accesses the 10G / 10G-EPON ONU under the split ratio 1:32 (the uplink and downlink traffic being 1Gbit/s and 10 Gbit/s respectively), the PON interface uplink packet loss rate is less than 20%, and the PON interface downlink packet loss rate is less than 17%.
Long-term packet loss rate		Under a certain traffic flow (90% of the throughput), the long-term (24 hours) packet loss rate of Ethernet service is 0.

Table 5-4 The Voice Service Performance of the Equipment

Item	Specification
Voice encoding dynamic switching period	< 60ms
Voice interruption and jitter occurrence	0
Objective evaluation of voice	Under very good network condition: PSQM average value < 1.5
	Under bad network condition (packet loss rate = 1%, jitter = 20 ms, delay = 100 ms): PSQM average value < 1.8
	Under very bad network condition (packet loss rate = 5%, jitter = 60 ms, delay = 400 ms): PSQM average value < 2.0
Subjective evaluation of voice	Under very good network condition: The packaging interval of G.711A RTP packets is 20 ms; MOS > 4.0
	Under bad network condition (packet loss rate = 1%, jitter = 20 ms, delay = 100 ms): The packaging interval of G.711A RTP packets is 20 ms; MOS > 3.5
	Under very bad network condition (packet loss rate = 5%, jitter = 60 ms, delay = 400 ms), the packaging interval of G.711A RTP packets is 20 ms; MOS > 3.0.
Encoding rate	For G.711, the encoding rate = 64 kbit/s
	For G.729a, the encoding rate < 18 kbit/s
	For G.723.1 (5.3), the encoding rate < 18 kbit/s
	For G.723.1 (6.3), the encoding rate < 15 kbit/s
Loopback delay	For G.729a, the loopback delay < 150 ms
	For G.723.1, the loopback delay < 200 ms
Call loss rate	The call lost rate is less than 0.01%.

Table 5-5 The TDM Service Performance of the Equipment

Item	Specification
Bit error ratio	Under normal condition, BER of an E1 path in 24 hours is 0.
Latency (EPON system)	Under the normal condition, the latency from the ONU's E1 interface to the OLT's E1 uplink port is less than 1.5 ms.
Latency (GPON system)	Under the normal condition, the latency from the ONU's E1 interface to the OLT's E1 uplink port is less than 1.5 ms.
Jitter transmission features	When $0 \text{ Hz} \leq f \leq 40 \text{ Hz}$ , the gain is equal to 0.5 dB.
	When $40 \text{ Hz} \leq f \leq 400 \text{ Hz}$ , the gain decreases as frequency increases.
	When $f \geq 400 \text{ Hz}$ , the gain is equal to -19.5 dB.

Table 5-5 The TDM Service Performance of the Equipment (Continued)

Item	Specification
Transmitting optical power	The range of mean launched optical power of STM-1 optical interface: -8 to -15 dBm.
Input interface receiving sensitivity	The input interface receiving sensitivity of STM-1 optical interface is lower than or equal to -31dBm.
Input interface overload optical power	The input interface overload optical power of STM-1 optical interface is higher than or equal to -8 dBm.
Input allowable frequency offset	The input allowable frequency offset of the STM-1 optical interface is higher than or equal to $\pm 20$ ppm.

## 5.1.2 Access Capability

Table 5-6 The Access Capability of the Equipment

Item	Access Capability Description
Maximum quantity of PON interfaces for a single subrack	256 EPON / GPON interfaces
	A hundred and twenty-eight 10G EPON interfaces
Maximum quantity of terminal subscribers for a single subrack	8000
Maximum quantity of Ethernet interfaces for a single subrack	256 GE optical / electrical interfaces
Maximum quantity of uplink ports for a single subrack	Two 10GE optical interfaces + eight GE optical / electrical interfaces (HU1A)
	Two 10GE optical interfaces + eight GE optical / electrical interfaces (HU1B)
	Four 10GE optical interfaces + four GE optical / electrical interfaces (HU2A)
	Eight 10GE optical interfaces (HU4A)
	12 GE optical / electrical interfaces (GU6F / GU6B)
Maximum quantity of STM-1 optical interfaces for a single subrack	30 STM-1 optical interfaces (1+1 protection)
Maximum quantity of E1 interfaces for a single subrack	480 E1 interfaces

### 5.1.3 Reliability Specifications

See Table 5-7 for the card reliability specifications; see Table 5-8 for the equipment reliability specifications.

Table 5-7 The Card Reliability Specifications

Card	MTBF (hour)	MTBF (year)	Failure Rate (ppm)
HSWA	148037.24	16.90	6.755
HSWD	148037.24	16.90	6.755
HU1A	339725.81	38.78	2.944
HU1B	327412.37	37.37	3.054
HU2A	339274.78	38.73	2.947
HU4A	339968.27	38.91	2.942
GU6F	358163.67	40.89	2.792
GU6B	312578.24	35.68	3.199
EC4B	149971.26	17.12	6.668
EC8B	150966.18	17.23	6.624
ECOB	150865.43	17.21	6.701
GC4B	146411.36	16.71	6.830
GC8B	146606.07	16.74	6.821
GCOB	146738.59	16.76	6.811
XG8A	150847.2	17.22	6.63
C155A	147353.56	16.89	6.790
TIMA	146503.37	16.73	6.818
CE1B	143050.78	16.33	6.990
GSOF	181156.80	20.68	5.520

Note 1: The MTTR (mean time to repair) of each card is 0.5 hour.

Table 5-8 The Equipment Reliability Specifications

Configuration Model	MTBF (hour)	MTBF (year)	Failure Rate (ppm)	Availability
IP uplink, 4096 lines	125906.76	14.37	7.942	0.99999205

Note 1: The MTTR (mean time to repair) of the entire system is 0.5 hour.

## 5.2 Interface Specifications

The following introduces the specifications of the interfaces on the equipment.

### 5.2.1 Specifications of Interfaces on the EC4B / EC8B / ECOB Card

Table 5-9 Specifications of Interfaces on the EC4B / EC8B / ECOB Card

Item		1.25Gbit/s EPON Interface
Interface type		SC / PC
Transmitter	Nominal bit rate	1.25 Gbit/s $\pm$ 100 ppm
	Wavelength range	1480 nm to 1500 nm
	Mean launched power (maximum)	+7 dBm
	Mean launched power (minimum)	+2 dBm
	Average launched power of OFF transmitter	-39 dBm
	Extinction ratio (minimum)	+9 dB
Receiver	Nominal bit rate	1.25 Gbit/s $\pm$ 100 ppm
	Wavelength range	1260 nm to 1360 nm
	Receiver sensitivity (maximum)	-27 dBm
	Minimum overload power	-3 dBm

### 5.2.2 Specifications of Interface on the XG8A Card

Table 5-10 Specifications of Interface on the XG8A Card

Item		1.25 Gbit/s 10G EPON Interface	10 Gbit/s 10G EPON Interface
Interface type		SC / PC	SC / PC
Transmitter	Nominal bit rate	1.25 Gbit/s $\pm$ 100 ppm	10 Gbit/s $\pm$ 100 ppm
	Wavelength range	1480 nm to 1500 nm	1574 nm to 1580 nm
	Mean launched power (maximum)	+5 dBm	+5 dBm
	Mean launched power (minimum)	+2 dBm	+2 dBm

Table 5-10 Specifications of Interface on the XG8A Card (Continued)

Item		1.25 Gbit/s 10G EPON Interface	10 Gbit/s 10G EPON Interface
	Average launched power of OFF transmitter	-42 dBm	-42 dBm
	Extinction ratio (minimum)	+9 dB	+6 dB
Receiver	Nominal bit rate	1.25 Gbit/s $\pm$ 100 ppm	10 Gbit/s $\pm$ 100 ppm
	Wavelength range	1280 nm to 1340 nm	1260 nm to 1280 nm
	Receiver sensitivity (maximum)	-30 dBm	-28 dBm
	Minimum overload power	-9.3 dBm	-6 dBm

### 5.2.3 Interface Specifications of the GC4B / GC8B / GCOB Card

Table 5-11 Interface Specifications of the GC4B / GC8B / GCOB Card (Class B+)

Item		Specification
Interface type		SC/PC
Transmitter	Signal nominal rate	2.5 Gbit/s $\pm$ 100 ppm
	Wavelength range	1480 nm to 1500 nm
	Mean launched power (maximum)	+5 dBm
	Mean launched power (minimum)	+1.5 dBm
	Average launched power of OFF transmitter	-39 dBm
	Extinction ratio (minimum)	+9 dB
Receiver	Signal nominal rate	1.25 Gbit/s $\pm$ 100 ppm
	Wavelength range	1260 nm to 1360 nm
	Maximum receiving sensitivity	-28 dBm
	Minimum overload optical power	-8 dBm



Table 5-12 Interfaces Specifications of the GC4B / GC8B / GCOB Card (Class C+)

Item		Specification
Interface type		SC/PC
Transmitter	Signal nominal rate	2.5 Gbit/s $\pm$ 100 ppm
	Wavelength range	1480 nm to 1500 nm
	Mean launched power (maximum)	+7 dBm
	Mean launched power (minimum)	+3 dBm
	Average launched power of OFF transmitter	-39 dBm
	Extinction ratio (minimum)	+9 dB
Receiver	Signal nominal rate	1.25 Gbit/s $\pm$ 100 ppm
	Wavelength range	1260 nm to 1360 nm
	Maximum receiving sensitivity	-30 dBm
	Minimum overload optical power	-8 dBm

## 5.2.4 Interface Specifications of the HU1A / HU1B / HU2A Card

Table 5-13 Specifications of 10GE Optical Interfaces on the the HU1A / HU1B / HU2A Card

Item	10000Base-SR	10000Base-LR
Interface Type	LC/PC	LC/PC
Interface rate	10000 Mbit/s	10000 Mbit/s
Applicable standard	IEEE 802.3ae	IEEE 802.3ae
Central wavelength	850nm	1310nm
Maximum transmission distance	300m	10km
Maximum transmitting optical power	-1 dBm	0.5dBm
Minimum transmitting optical power	-7.3 dBm	-8.2 dBm
Minimum overload optical power	0	-1 dBm
Maximum receiving sensitivity	-11 dBm	-12.6 dBm
Minimum extinction ratio	3 dB	3.5 dB

Table 5-14 Specifications of GE Optical Interfaces on the the HU1A / HU1B / HU2A Card

Item	1000Base-SX	1000Base-LX
Interface Type	LC/PC	LC/PC
Interface rate	1000 Mbit/s	1000 Mbit/s
Applicable standard	IEEE 802.3z	IEEE 802.3z
Central wavelength	850nm	1310nm
Maximum transmission distance	500m	20km
Maximum transmitting optical power	-4 dBm	-3 dBm
Minimum transmitting optical power	-9.5 dBm	-11.5 dBm
Minimum overload optical power	0	-3 dBm
Maximum receiving sensitivity	-17 dBm	-19 dBm
Minimum extinction ratio	9 dB	9 dB

Table 5-15 Specifications of Ethernet Electrical Interfaces on the the HU1A / HU1B / HU2A Card

Item	10/100/1000Base-T
Interface Type	RJ-45
Interface rate	Auto-negotiated to 10 / 100 / 1000 Mbit/s
Transmission media	CAT-5
Applicable standard	IEEE 802.3-2005
Transmission distance	100m

## 5.2.5 Interface Specifications of the HU4A Card

Table 5-16 Ethernet Optical Interface Specifications of the HU4A Card

Item	10000Base-SR
Interface Type	LC/PC
Interface rate	10000 Mbit/s
Applicable standard	IEEE 802.3ae
Central wavelength	850 nm
Maximum transmission distance	300m
Maximum transmitting optical power	-1 dBm

Table 5-16 Ethernet Optical Interface Specifications of the HU4A Card (Continued)

Item	1000Base-SR
Minimum transmitting optical power	-6 dBm
Minimum overload optical power	0
Maximum receiving sensitivity	-11 dBm
Minimum extinction ratio	3 dB

## 5.2.6 Interface Specifications of the GU6F / GU6B / GSOF Card

Table 5-17 Specifications of Ethernet Optical Interfaces on the GU6F / GU6B / GSOF Card

Item	1000Base-SX	1000Base-LX
Interface Type	LC/PC	LC/PC
Interface rate	1000 Mbit/s	1000 Mbit/s
Applicable standard	IEEE 802.3z	IEEE 802.3z
Central wavelength	850 nm	1310 nm
Maximum transmission distance	500m	20km
Maximum transmitting optical power	-4 dBm	-3 dBm
Minimum transmitting optical power	-9.5 dBm	-11.5 dBm
Minimum overload optical power	0	-3 dBm
Maximum receiving sensitivity	-17 dBm	-19 dBm
Minimum extinction ratio	9 dB	9 dB

Table 5-18 Specifications of Ethernet Electrical Interfaces on the GU6F / GU6B / GSOF Card

Item	10/100/1000Base-T
Interface Type	RJ-45
Interface rate	Auto-negotiated to 10 / 100 / 1000 Mbit/s
Transmission media	CAT-5
Applicable standard	IEEE 802.3-2005
Transmission distance	100m

## 5.2.7 Interface Specifications of the CE1B Card

Table 5-19 Interface Specifications of the CE1B Card

Item	Specification	
Pulse shape	All marks of effective signals comply with pulse mask in Figure 5-1.	
Nominal frequency	2048 kbit/s $\pm$ 50 ppm	
Pairs per direction	The outer conductor of the input port and output port of the coaxial pair is connected to ground.	
Test load impedance	75 $\Omega$ , resistive	120 $\Omega$ , resistive
Nominal peak voltage of a <b>mask</b> (pulse)	2.37V	3V
Nominal peak voltage of a <b>mask</b> (no pulse)	0 $\pm$ 0.237V	0 $\pm$ 0.3V
Nominal pulse width	244 ns	
Ratio of the amplitudes of positive and negative pulses at the centre of the pulse interval	0.95 to 1.05	
Ratio of the widths of positive and negative pulses at the nominal half amplitude	0.95 to 1.05	
Code type	HDB3	

## 5.2.8 Interface Specifications of the C155A Card

Table 5-20 Interface Specifications of the C155A Card

Item	Specification				
Interface type	SC/PC				
Nominal bit rate	155 520 kbit/s				
Application code	S-1.1	L-1.1	L-1.2		
Operating wavelength range	1261 nm to 1360 nm	1263 nm to 1360 nm		1480 nm to 1580 nm	
Transmitter at reference point S	Source type	MLM	MLM	SLM	SLM
	Maximum RMS width (s)	7.7 nm	3 nm	-	-
	Maximum -20 dB width	-	-	1 nm	1 nm
	Minimum side mode suppression ratio	-	-	30 dB	30 dB
	Maximum mean launched power	-8 dBm	0		0

Table 5-20 Interface Specifications of the C155A Card (Continued)

Item		Specification		
	Minimum mean launched power	-15 dBm	-5 dBm	
	Minimum extinction ratio	8.2 dB	10 dB	
Optical path between S and R	Attenuation range	0 to 12 dB	10 dB to 28 dB	
	Maximum dispersion	96 ps/nm	246 ps/nm	NA
	Minimum optical return loss of cable plant at S , including any connectors	NA	NA	
	Maximum discrete reflectance between S and R	NA	NA	
Receiver at reference point R	Minimum sensitivity (BER $\leq 10^{-12}$ )	-28 dBm	-34 dBm	
	Minimum overload (BER $\leq 10^{-12}$ )	-8 dBm	-10 dBm	
	Maximum optical path penalty	1 dB	1 dB	
	maximum reflectance of receiver, measured at R	NA	NA	

## 5.2.9 Interface Specifications of the HSWA Card

Table 5-21 Interface Specifications of the HSWA Card

Item	Specification
Interface type	RJ-45
Interface standard	Asynchronous EIA / TIA-232
Rate	9600 bit/s

## 5.2.10 Interface Specifications of the HSWD Card

Table 5-22 Interface Specifications of the HSWD Card

Item	Specification
Interface Type	RJ-45
Interface standard	Asynchronous EIA / TIA-232
Rate	9600 bit/s

## 5.2.11 Interface Specifications of the TIMA Card

Table 5-23 Electrical Interface Specifications of the TIMA Card

Item	1000BASE-TX	Coaxial plug
Interface Type	RJ-45	RG-59
Interface standard	IEEE 802.3-2005	ITU-T G.703
Rate	1000 Mbit/s	2 Mbit/s

Table 5-24 Optical Interface Specifications of the TIMA Card

Item	SFP
Interface Type	LC/PC
Interface rate	1000 Mbit/s
Applicable standard	IEEE 802.3z
Central wavelength	850nm
Maximum transmission distance	500m
Maximum transmitting optical power	-4 dBm
Minimum transmitting optical power	-9.5 dBm
Minimum overload optical power	0
Maximum receiving sensitivity	-17 dBm
Minimum extinction ratio	9 dB
Rate	1000 bit/s

## 5.3 Mechanical Dimensions and Weight

Table 5-25 Mechanical Dimensions and Weight of the Equipment

Item	Dimensions (Height × Width × Depth)	Weight
Cabinet	2600mm × 600 mm × 600mm	134kg
	2200mm × 600 mm × 600mm	117kg
	2000mm × 600 mm × 600mm	109kg
	1600mm × 600 mm × 600mm	94kg
	2600mm × 600 mm × 300mm	85kg
	2200mm × 600 mm × 300mm	74kg
	2000mm × 600 mm × 300mm	69kg
	1600mm × 600 mm × 300mm	58kg
Empty subrack (including the fan)	471.65mm × 480.8mm × 262.7mm	20kg
Subrack (fully configured)	471.65mm × 480.8mm × 262.7mm	30kg

## 5.4 Power Supply and Power Consumption

See Table 5-26 for the power consumption of the AN5116-06B's cards under the -48V DC power supply.

Table 5-26 Power Consumption of the Equipment's Cards

Card	Power Consumption	Card	Power Consumption
HSWA	≤40W	C155A	≤ 40 W
HSWD	≤160W	GU6F	≤ 10W
EC4B	≤ 40W	HU1A	≤ 10W
ECOB	≤58W	HU1B	≤20W
GC4B	≤ 40W	HU2A	≤ 10W
EC8B	≤ 60W	HU4A	≤20W
GC8B	≤ 50W	GSOF	≤30W
GCOB	≤80W	TIMA	≤10W
XG8A	≤108W	Fan unit	≤ 196W
CE1B	≤ 40W	GU6B	≤20W

## 5.5 Equipment Room Requirement

The following introduces the requirements on the equipment room for the AN5116-06B.

### 5.5.1 Power Supply Requirement

- ◆ Equipment room voltage: -48 V DC (-40 V to -57 V).
- ◆ The equipment room should be equipped with the UPS power supply that can run at least 8 hours continuously.

### 5.5.2 Working Environment

- ◆ Ground bearing of the equipment room:  $> 600 \text{ kg/m}^2$ .
- ◆ No corrosive and solvent gas, and no dust in the atmosphere; no strong electromagnetic field nearby.
- ◆ The dust in the environment should be non-conductive of both electricity and magnetism, and noncorrosive; the dust (diameter  $> 5 \text{ }\mu\text{m}$ ) concentration index should be  $\leq 3 \times 10^4/\text{m}^3$ .
- ◆ Grounding resistance:  $< 10 \text{ }\Omega$ .
- ◆ Atmospheric pressure: 86 kPa to 106 kPa
- ◆ Operating temperature:  $0^\circ\text{C}$  to  $45^\circ\text{C}$
- ◆ Storage temperature:  $-30^\circ\text{C}$  to  $60^\circ\text{C}$

## 5.6 Standard and Protocol

The following introduces the standards and protocols that the equipment complies with.



## 5.6.1 Environment Standard

Standard Number	Name
ANSI/UL 94-2006	Tests for Flammability of Plastic Materials for Parts in Devices and Appliances (Proposal dated March 17, 2006)
BS EN 60950-1-2006	Information technology equipment - Safety - General requirements
BS EN 60950-22-2006	Information technology equipment - Safety - Equipment installed outdoors
ETSI EN 300 019-1-3	Environmental Engineering (EE); Environmental conditions and environmental tests for telecommunications equipment; Part 1-3: Classification of environmental conditions; Stationary use at weatherprotected locations
IEC 60917-1	Modular order for the development of mechanical structures for electronic equipment practices - Part 1: Generic standard
IEC 60917-1-amd1	Amendment 1 - Modular order for the development of mechanical structures for electronic equipment practices - Part 1: Generic standard
IEC 60917-2	Modular order for the development of mechanical structures for electronic equipment practices - Part 2: Sectional specification - Interface co-ordination dimensions for the 25 mm equipment practice
IEC 60917-2-1	Modular order for the development of mechanical structures for electronic equipment practices - Part 2: Sectional specification - Interface co-ordination dimensions for the 25 mm equipment practice - Section 1: Detail specification - Dimensions for cabinets and racks
IEC 60917-2-2	Modular order for the development of mechanical structures for electronic equipment practices - Part 2: Sectional specification - Interface co-ordination dimensions for the 25 mm equipment practice - Section 2: Detail specification - Dimensions for subracks, chassis, backplanes, front panels and plug-in units
IEC 60917-2-3	Modular order for the development of mechanical structures for electronic equipment practices - Part 2-3: Sectional specification - Interface co-ordination dimensions for the 25 mm equipment practice - Extended detail specification - Dimensions for subracks, chassis, backplanes, front panels and plug-in units
IEC 60950-22-2005	Information technology equipment - Safety - Part 22: Equipment to be installed outdoors

Standard Number	Name
IEC 61587-1-2007	Mechanical structures for electronic equipment - Tests for IEC 60917 and IEC 60297 - Part 1: Climatic, mechanical tests and safety aspects for cabinets, racks, subracks and chassis
IEC 61587-2-2000	Mechanical structures for electronic equipment - Tests for IEC 60917 and IEC 60297 - Part 2: Seismic tests for cabinets and racks
IEC 61587-3-2006	Mechanical structures for electronic equipment - Tests for IEC 60917 and IEC 60297 - Part 3: Electromagnetic shielding performance tests for cabinets, racks and subracks
UL 94-1996	UL Standard for Safety Test for Flammability of Plastic Materials for Parts in Devices and Appliances Fifth Edition

## 5.6.2 Electromagnetic Compatibility Standard

Standard Number	Name
CISPR 22	Information technology equipment – Radio Disturbance characteristics – Limits and methods of measurement
CISPR 24	Information technology equipment - Immunity characteristics - Limits and methods of measurement
EN 300 386	Electromagnetic compatibility and Radio spectrum Matters (ERM); Telecommunication network equipment; Electromagnetic Compatibility (EMC) requirements
EN 55022	Information technology equipment - Radio disturbance characteristics - Limits and methods of measurement
EN 55024	Information technology equipment - Immunity characteristics - Limits and methods of measurement
EN 61000-4-2	Electromagnetic compatibility (EMC) - Part 4 - 2: Electrostatic discharge immunity test
EN 61000-4-3	Electromagnetic compatibility (EMC) - Part 4 - 3: Testing and measurement techniques-Radiated, radio-frequency, electromagnetic field immunity test
EN 61000-4-4	Electromagnetic compatibility (EMC) - Part 4 - 4: Testing and measurement techniques-Electrical fast transient/burst immunity test
EN 61000-4-5	Electromagnetic compatibility (EMC) - Part4 - 5: Testing and measurement techniques-Surge immunity test
EN 61000-4-6	Electromagnetic compatibility (EMC) - Part 4 - 5: Testing and measurement techniques-Immunity to conducted disturbances, induced by radio-frequency fields

Standard Number	Name
ETSI EN 300132-2	Power supply interface at the input telecommunications equipment; Part 2: Operated by direct current (DC)
ETSI EN 300386 V 1.4.1	Electromagnetic compatibility and Radio spectrum Matters (ERM); Telecommunication network equipment; Electromagnetic Compatibility (EMC) requirements
IEC 61000-4-2	Electromagnetic compatibility (EMC) - Part 4 - 2: Testing and measurement techniques-Electrostatic discharge immunity test
IEC 61000-4-3	Electromagnetic compatibility (EMC) - Part 4 - 3: Testing and measurement techniques-Radiated, radio-frequency, electromagnetic field immunity test
IEC 61000-4-4	Electromagnetic compatibility (EMC) - Part 4 - 4: Testing and measurement techniques-Electrical fast transient/burst immunity test
IEC 61000-4-5	Electromagnetic compatibility (EMC) - Part4 - 5: Testing and measurement techniques-Surge immunity test
IEC 61000-4-6	Electromagnetic compatibility (EMC) - Part 4 - 6: Testing and measurement techniques-Immunity to conducted disturbances, induced by radio-frequency fields
ITU-T K.20	Resistibility of telecommunication equipment installed in a telecommunications centre to overvoltages and overcurrents
ITU-T K.43	Immunity requirements for telecommunication equipment
ITU-T K.48	EMC requirements for telecommunication equipment - Product family Recommendation
EN 300 386	Electromagnetic compatibility requirement for telecommunication network equipment
CISPR 22 (EN55022)	Information technology equipment-Radio Disturbance characteristics-Limits and methods of measurement
CISPR 24 (EN55024)	Information technology equipment-Immunity characteristics-Limits and methods of measurement

### 5.6.3 Safety Standard

Standard Number	Name
EN 60825-1	Safety of laser products - Part 1: Equipment classification and requirements
EN 60825-2	Safety of laser products - Part 2: Safety of optical fibre communication

Standard Number	Name
EN 60950-1	Information technology equipment -Safety - Part 1: General Requirements
IEC 60825-1	Safety of laser products - Part 1: Equipment classification and requirements
IEC 60825-2	Safety of laser products - Part 2: Safety of optical fibre communication
IEC 60950-2001	Safety of Information technology equipment including Electrical Business Equipment
UL 60950-1:2003	Information Technology Equipment - Safety - Part 1: General Requirements

## 5.6.4 10G EPON Standard

Standard Number	Name
IEEE802.3av-2009	IEEE Standard for Information technology-Telecommunications and information exchange between systems-Local and metro politan area networks-Specific requirements Part 3:Carrier Sense Multiple Access with Collision Detection (CDMA/CD) Access Method and Physical Layer Specifications Amendment 1:Physical Layer Specifications and Management Parameters for 10 Gb/s Passive Optical Networks

## 5.6.5 EPON Standard

Standard Number	Name
DSL Forum TR-069	CPE WAN Management Protocol
DSL Forum WT-142	Framework for TR-069 enabled PON devices (Revision 3)
IEEE 802.3-2005	IEEE Standard for Information technology-Telecommunications and information exchange between systems-Local and metropolitan area networks- Specific requirements Part 3: Carrier Sense Multiple Access with Collision Detection (CSMA/CD) Access Method and Physical Layer Specifications

## 5.6.6 GPON Standard

Standard Number	Name
ITU-T G.984.1	Gigabit-capable passive optical networks (GPON): General characteristics
ITU-T G.984.2	Gigabit-capable Passive Optical Networks (GPON): Physical Media Dependent (PMD) layer specification
ITU-T G.984.3	Gigabit-capable Passive Optical Networks (G-PON): Transmission convergence layer specification
ITU-T G.Imp984.3	Implementers' Guide for ITU-T Rec. G.984.3 (02/2004)
ITU-T G.984.4	Gigabit-capable passive optical networks (G-PON): ONT management and control interface specification
ITU-T G.Imp.984.4	Implementor's Guide for ITU-T Rec. G.984.4
ITU-T G.984.5	Enhancement band for gigabit capable optical access networks
ITU-T G.984.6	Gigabit-capable passive optical networks (GPON): Reach extension
ITU-T G.988	ONU management and control interface (OMCI) specification

## 5.6.7 Ethernet Protocol

Standard Number	Name
IEEE 802-2001	IEEE Standard for Local and Metropolitan Area Networks: Overview and Architecture
IEEE 802.1ad	IEEE Standard for Local and Metropolitan Area Networks - Virtual Bridged Local Area Networks - Amendment 4: Provider Bridges
IEEE 802.1ag-2007	IEEE Standard for Local and Metropolitan Area Networks Virtual Bridged Local Area Networks Amendment 5: Connectivity Fault Management
IEEE 802.1w-2001	Local and metropolitan area networks - Common specifications - Part 3: Media access control (MAC) bridges; Amendment 2: Rapid reconfiguration
IEEE 802.1x-2004	IEEE Standard for Local and Metropolitan Area Networks Port-Based Network Access Control
IEEE 802.1D-2004	IEEE Standard for Local and metropolitan area networks: Media Access Control (MAC) Bridges
IEEE 802.1Q-2005	IEEE Standard for Local and Metropolitan Area Networks - Virtual Bridged Local Area Networks - Amendment 4: Provider Bridges

Standard Number	Name
IEEE 802.3ah	IEEE Standard for Information technology- Telecommunications and information exchange between systems- Local and metropolitan area networks- Specific requirements Part 3: Carrier Sense Multiple Access with Collision Detection (CSMA/CD) Access Method and Physical Layer Specifications Amendment: Media Access Control Parameters, Physical Layers, and Management Parameters for Subscriber Access Networks
IEEE 802.1s-2002	IEEE Standards for Local and metropolitan area networks - Virtual Bridged Local Area Networks - Amendment 3: Multiple Spanning Trees
ITU-T Y.1291	An architectural framework for support of Quality of Service in packet networks
ITU-T Y.1730	Requirements for OAM functions in Ethernet-based networks and Ethernet services
TR-101	Migration to Ethernet-Based DSL Aggregation

## 5.6.8 Routing Protocol

Standard Number	Name
IETF RFC 2362	Protocol Independent Multicast-Sparse Mode
IETF RFC 1723	RIP Version 2 Carrying Additional Information
IETF RFC 2453	RIP Version 2

## 5.6.9 NGN Protocol

Standard Number	Name
IETF RFC 3435	RFC 3435- Media Gateway Control Protocol (MGCP) Version 1.0
ITU-T G.711	Pulse code modulation (PCM) of voice frequencies
ITU-T G.711.1	Wideband embedded extension for G.711 pulse code modulation
ITU-T G.723.1	Dual rate speech coder for multimedia communications transmitting at 5.3 and 6.3 kbit/s
ITU-T G.729	Coding of speech at 8 kbit/s using conjugate-structure algebraic-code-excited linear prediction (CS-ACELP)
ITU-T G.729.1	G.729 based Embedded Variable bit-rate coder: An 8-32 kbit/s scalable wideband coder bitstream interoperable with G.729
ITU-T G. Imp 729	Implementers' Guide for G.729 Annexes B, F, G, I and C+ (Coding of speech at 8 kbit/s using CS-ACELP)

## 5.6.10 IMS Protocol

Standard Number	Name
3GPP TS 23.228	IP Multimedia Subsystem (IMS)
3GPPTS24.228	Signaling flows for the IP multimedia call control based on SIP and SDP
3GPP TS 24.229	IP Multimedia Call Control Protocol based on SIP and SDP
RFC3261	SIP: Session Initiation Protocol

## 5.6.11 TDM Service Standard

Standard Number	Name
IETF RFC3985 (2005)	PWE3 Architecture
IETF RFC4197 (2005)	Requirements for Edge-to-Edge Emulation of Time Division Multiplexed (TDM) Circuits over Packet Switching Networks
IETF RFC4553 (2006)	Structure-Agnostic Time Division Multiplexing (TDM) over Packet (SAToP)
ITU-T G.703	Physical/electrical characteristics of hierarchical digital interfaces
ITU-T G.812	Timing requirements of slave clocks suitable for use as node clocks in synchronization networks
ITU-T G.813	Timing characteristics of SDH equipment slave clocks (SEC)
ITU-T G.823	The control of jitter and wander within digital networks which are based on the 2048 kbit/s hierarchy
ITU-T G.824	The control of jitter and wander within digital networks which are based on the 1544 kbit/s hierarchy
ITU-T G.8261	Timing and synchronization aspects in packet networks
TelcordiaGR-1244-CORE/GR-253	Clocks for the Synchronized Network: Common Generic Criteria

## 5.6.12 Time Standard

Standard Number	Name
IEEE 1588-2008	IEEE Standard for a Precision Clock Synchronization Protocol for Networked Measurement and Control Systems
IETF RFC 1305	Network Time Protocol (Version 3) Specification, Implementation and Analysis
IETF RFC 2030	Simple Network Time Protocol (SNTP) Version 4 for IPv4, IPv6 and OSI

### 5.6.13 Other Standard and Protocol

Standard Number	Name
IETF RFC 2284	PPP Extensible Authentication Protocol (EAP)
SFF-8472	Specification for Diagnostic Monitoring Interface for Optical Transceivers (Rev 10.3 Dec.1, 2007)



# Appendix A Abbreviations

---

<b>ACL</b>	Access Control List
<b>ARP</b>	Address Resolution Protocol
<b>ARPU</b>	Average Revenue Per User
<b>BRAS</b>	Broadband Remote Access Server
<b>BSC</b>	Base Station Controller
<b>CATV</b>	Cable Antenna Television
<b>CDR</b>	Call Detail Record
<b>CLI</b>	Command Line Interface
<b>CoS</b>	Class of Service
<b>DBA</b>	Dynamic Bandwidth Allocation
<b>DHCP</b>	Dynamic Host Configuration Protocol
<b>DSL</b>	Digital Subscriber Line
<b>DSLAM</b>	Digital Subscriber Line Access Multiplexer
<b>EMC</b>	Electro Magnetic Compatibility
<b>EPON</b>	Ethernet Passive Optical Network
<b>FDB</b>	Forwarding Database
<b>FEC</b>	Forward Error Correction
<b>FoIP</b>	Fax over IP
<b>FTTB</b>	Fiber To The Building
<b>FTTC</b>	Fiber To The Curb
<b>FTTH</b>	Fiber To The Home
<b>FTTM</b>	Fiber To The Mobile
<b>FTTO</b>	Fiber To The Office
<b>FTTV</b>	Fiber To The Village
<b>GEM</b>	GPON Encapsulation Mode
<b>GPON</b>	Gigabit-capable Passive Optical Network
<b>GUI</b>	Graphical User Interface
<b>ICMP</b>	Internet Control Message Protocol
<b>IGMP</b>	Internet Group Management Protocol
<b>IMS</b>	IP Multimedia Subsystem
<b>IP</b>	Internet Protocol
<b>LAN</b>	Local Area Network
<b>MAC</b>	Medium Access Control

<b>MGC</b>	Media Gateway Controller
<b>MGCP</b>	Media Gateway Control Protocol
<b>MoIP</b>	Modem over IP
<b>MTBF</b>	Mean Time Between Failure
<b>NGN</b>	Next Generation Network
<b>OAM</b>	Operation, Administration And Maintenance
<b>ODN</b>	Optical Distribution Network
<b>OLT</b>	Optical Line Termination
<b>ONU</b>	Optical Network Unit
<b>OSPF</b>	Open Shortest Path First
<b>P2MP</b>	Point to Multiple Point
<b>PDH</b>	Plesynchronous Digital Hierarchy
<b>PDP</b>	Power Distribution Panel
<b>PoE</b>	Power over Ethernet
<b>PON</b>	Passive Optical Network
<b>POTS</b>	Plain Old Telephone Service
<b>ppm</b>	parts per million
<b>QoS</b>	Quality of Service
<b>RIP</b>	Routing Information Protocol
<b>RNC</b>	Radio Network Controller
<b>SBA</b>	Static Bandwidth Allocation
<b>SCB</b>	Single Copy Broadcast
<b>SDH</b>	Synchronous Digital Hierarchy
<b>SFP</b>	Small Form-factor Pluggable transceiver
<b>SIP</b>	Session Initiation Protocol
<b>SNI</b>	Service Node Interface
<b>SNMP</b>	Simple Network Management Protocol
<b>SP</b>	Strict Priority
<b>STB</b>	Set Top Box
<b>STM</b>	Synchronous Transport Module
<b>TCP</b>	Transmission Control Protocol
<b>TDM</b>	Time Division Multiplex
<b>TG</b>	Trunk Gate Way
<b>ToS</b>	Type of Service
<b>UDP</b>	User Datagram Protocol
<b>UNI</b>	User-Network Interface

<b>VDN</b>	Video Distribution Network
<b>VLAN</b>	Virtual Local Area Network
<b>VoIP</b>	Voice over Internet Protocol
<b>WRR</b>	Weighted Round Robin



# Product Documentation Customer Satisfaction Survey

Thank you for reading and using the product documentation provided by FiberHome. Please take a moment to complete this survey. Your answers will help us to improve the documentation and better suit your needs. Your responses will be confidential and given serious consideration. The personal information requested is used for no other purposes than to respond to your feedback.

Name	
Phone Number	
Email Address	
Company	

To help us better understand your needs, please focus your answers on a single documentation or a complete documentation set.

Documentation Name	
Code and Version	

## Usage of the product documentation:

1. How often do you use the documentation?

Frequently  Rarely  Never  Other (please specify) \_\_\_\_\_

2. When do you use the documentation?

in starting up a project  in installing the product  in daily maintenance  in trouble shooting  Other (please specify) \_\_\_\_\_

3. What is the percentage of the operations on the product for which you can get instruction from the documentation?

100%  80%  50%  0%  Other (please specify) \_\_\_\_\_

4. Are you satisfied with the promptness with which we update the documentation?

Satisfied  Unsatisfied (your advice) \_\_\_\_\_

5. Which documentation form do you prefer?

Print edition  Electronic edition  Other (please specify) \_\_\_\_\_

## Quality of the product documentation:

1. Is the information organized and presented clearly?

Very  Somewhat  Not at all (your advice) \_\_\_\_\_

2. How do you like the language style of the documentation?

Good  Normal  Poor (please specify) \_\_\_\_\_

3. Are any contents in the documentation inconsistent with the product?

\_\_\_\_\_

4. Is the information complete in the documentation?

Yes

No (Please specify) \_\_\_\_\_

5. Are the product working principles and the relevant technologies covered in the documentation sufficient for you to get known and use the product?

Yes

No (Please specify) \_\_\_\_\_

6. Can you successfully implement a task following the operation steps given in the documentation?

Yes (Please give an example) \_\_\_\_\_

No (Please specify the reason) \_\_\_\_\_

7. Which parts of the documentation are you satisfied with?

\_\_\_\_\_

8. Which parts of the documentation are you unsatisfied with? Why?

\_\_\_\_\_

9. What is your opinion on the Figures in the documentation?

Beautiful  Unbeautiful (your advice) \_\_\_\_\_

Practical  Unpractical (your advice) \_\_\_\_\_

10. What is your opinion on the layout of the documentation?

Beautiful  Unbeautiful (your advice) \_\_\_\_\_

11. Thinking of the documentations you have ever read offered by other companies, how would you compare our documentation to them?

Product documentations from other companies: \_\_\_\_\_

Satisfied (please specify) \_\_\_\_\_

Unsatisfied (please specify) \_\_\_\_\_

12. Additional comments about our documentation or suggestions on how we can improve:

\_\_\_\_\_

\_\_\_\_\_

Thank you for your assistance. Please fax or send the completed survey to us at the contact information included in the documentation. If you have any questions or concerns about this survey please email at [edit@fiberhome.com](mailto:edit@fiberhome.com)