



ADMINISTRATION GUIDE

Cisco Small Business Pro SPA9000 Voice System Version 6.1

SPA9000 Voice System, SPA400 Internet Telephony
Gateway with 4 FXO ports and SPA9XX IP Phones

CCDE, CCSI, CCENT, Cisco Eos, Cisco HealthPresence, the Cisco logo, Cisco Lumin, Cisco Nexus, Cisco Nurse Connect, Cisco Stackpower, Cisco StadiumVision, Cisco TelePresence, Cisco WebEx, DCE, and Welcome to the Human Network are trademarks; Changing the Way We Work, Live, Play, and Learn and Cisco Store are service marks; and Access Registrar, Aironet, AsyncOS, Bringing the Meeting To You, Catalyst, CCDA, CCDP, CCIE, CCIP, CCNA, CCNP, CCSP, CCVP, Cisco, the Cisco Certified Internetwork Expert logo, Cisco IOS, Cisco Press, Cisco Systems, Cisco Systems Capital, the Cisco Systems logo, Cisco Unity, Collaboration Without Limitation, EtherFast, EtherSwitch, Event Center, Fast Step, Follow Me Browsing, FormShare, GigaDrive, HomeLink, Internet Quotient, IOS, iPhone, iQuick Study, IronPort, the IronPort logo, LightStream, Linksys, MediaTone, MeetingPlace, MeetingPlace Chime Sound, MGX, Networkers, Networking Academy, Network Registrar, PCNow, PIX, PowerPanels, ProConnect, ScriptShare, SenderBase, SMARTnet, Spectrum Expert, StackWise, The Fastest Way to Increase Your Internet Quotient, TransPath, WebEx, and the WebEx logo are registered trademarks of Cisco Systems, Inc. and/or its affiliates in the United States and certain other countries.

All other trademarks mentioned in this document or website are the property of their respective owners. The use of the word partner does not imply a partnership relationship between Cisco and any other company. (0903R)

About This Document	ix
Purpose	ix
Audience	ix
Firmware	x
Organization	xi
Document Conventions	xii
Finding Information in PDF Files	xiii
Chapter 1: Getting Started	16
Introduction to the SPA9000 Voice System	16
SPA9000 IP PBX	17
SPA400 SIP-PSTN Gateway and Voicemail Server	18
IP Phones and Accessories	18
Deployment Scenarios	18
PSTN Access and Local Voice Mail	19
ITSP Service Only	20
ITSP Service, PSTN Access and Local Voice Mail	21
ITSP Service, PSTN and ISDN Access and Local Voice Mail	22
Initial Installation, and Configuration	23
Chapter 2: Basic Administration of the SPA9000	24
Upgrading Firmware for the SPA9000	25
Connecting to the SPA9000 Administration Web Server	27
Saving or Discarding Changes SPA9000	27
Access Levels	28
Setting Passwords for User and Administrator Accounts	29

Configuring Basic Settings	29
Setting Up the WAN Connection for the SPA9000	30
Setting the Date and Time	30
Configuring Daylight Saving Time	31
SPA9000 Ethernet Port	33
LAN and Application Guidelines	33
Configuring Multicast Addressing and Group Paging	33
Collecting System Logs and Debug Information	36
Viewing Information about the SPA9000	39
Viewing Information about Client Stations	39
Using the Interactive Voice Response Unit	40
Using the IVR Menu	40
Entering a Password through the IVR	45
Chapter 3: Configuring Your System for ITSP Interoperability	47
About the SPA9000 Voice System and SIP	47
Network Address Translation (NAT) and Voice over IP (VoIP)	49
NAT Mapping with Session Border Controller	49
NAT Mapping with SIP-ALG Router	49
Configuring NAT Mapping with a Static IP Address	49
Configuring NAT Mapping with STUN	51
Determining the Router's NAT Mechanism	53
Firewalls and SIP	54
Configuring SIP Timer Values	55
Chapter 4: Configuring Phone Lines and Calling Routing Behavior	56
Configuring SPA9000 FXS Ports	57

Configuring Line Interfaces on the SPA9000	58
Configuring a Line Interface for ITSP Service	58
Configuring a Line Interface for a SPA400 (PSTN or Voice Mail)	60
Configuring Call Capacity for a Line Interface	63
Configuring Dial Plans	66
About Dial Plans	66
Editing Dial Plans	74
Managing the Line Selection for Outbound Calls	78
Line Availability	78
Configuring a Call Routing Rule	79
Entering a Call Routing Rule	81
Managing Caller ID Settings for Outgoing Calls	82
Call Forwarding Support on SPA9000	82
Call Transfer Support on SPA9000	84
Call Forward Bridge Mode	84
Call Transfer Bridge Mode	84
Managing Inbound Calls with the Contact List	85
Routing an Inbound Call to the Auto Attendant	85
Routing an Inbound Call to a Receptionist or Client Stations	85
Example Contact List Rules	86
Supporting Multiple DID Numbers Per Line Interface	87
Supporting Direct Inward Dialing to Phone Extensions	88
Entering a Contact List Rule	91
Managing Inbound Calls with Hunt Groups	92
Syntax for Hunt Rules	93
Examples for Hunt Rules	94
Creating a Hunt Rule	96
Managing Inbound Calls with Shared Line Appearances	98

About Shared Line Appearances	98
Chapter 5: Administering the SPA400 and Voice Mail Service	102
Connecting to the SPA400 Administration Web Server	103
Configuring the SPA400 Network Connection	104
Saving or Discarding Changes on the SPA400	105
Managing Access to the SPA400 Configuration Utility	106
Upgrading the Firmware for the SPA400	107
Configuring a SPA400 to Interoperate with the SPA9000	108
Configuring a SPA400 for PSTN Access	111
Configuring a SPA400 for Voice Mail Service	112
Voice Mail Capacity	112
Configuring Local Voice Mail Service on a SPA400	113
Setting Up Voice Mail on Each Station	116
Enabling Remote Voice Mail Access (Optional)	119
Managing the Voice Mail Messages on the USB Key	121
Enabling Debugging on the SPA400	122
Chapter 6: Configuring Music on Hold	125
Using the Internal Music Source for Music On Hold	125
Using the Internal Music Source	125
Changing the Music File for the Internal Music Source	126
Configuring a Streaming Audio Server	127
About the Streaming Audio Server	127
Configuring the Streaming Audio Server	129
Using the IVR with an SAS Line	130

Chapter 7: Configuring the Auto Attendant	131
How the Auto Attendant Works	131
Working with the Auto Attendant Greetings	133
Using Pre-Recorded Prompts	133
Recording an Auto Attendant Prompt	134
Downloading Prompts	137
Writing an Auto Attendant Script	138
An Introduction to XML Scripting Grammar in AA Script Examples	138
Elements of XML Scripting Grammar	142
Auto Attendant XML Instructions Set	145
Entering an Auto Attendant Script	147
Configuring the DayTime, NightTime and Weekend/Holiday Auto Attendants	148
Configuring Dial Plans for the Auto Attendant	150
Chapter 8: Localization	151
Localizing the SPA9000 Auto Attendant Prompts	151
Local Time Configuration	154
Configuring the SPA9000 and SPA9xx Call Progress Tones	154
Localizing the SPA400 Voice Mail Prompts	160
Localizing the SPA400 Call Disconnect Tones	161
Localizing the SPA400 Caller ID Method	163
Appendix A: Advanced Topics in SPA9000 Administration	165
Technology Background	165
Session Initiation Protocol	166
SPA9000 Media Proxy	167

Using the SPA9000 with a Firewall or Router	168
SPA400 SIP-PSTN Gateway	169
SPA9000 Architecture	170
SIP-NAT Interoperation	172
Advanced Call Control and Routing	173
Configuring Vertical (Supplementary) Service Codes	173
Managing the Outbound Call Routing Groups	175
Configuring Outbound Call Codec Selection Codes	177
Advanced Topics for SPA400 Voice Mail Service	178
How Voicemail Works	179
Checking Voicemail from an External Number	180
Depositing Voicemail	180
Subscribing to Voicemail Notification	182
Remote Provisioning Features	183
Using Configuration Profiles	183
Client Auto-Configuration	184
Manual Client Configuration	185
Client Registration	188
Using the Upgrade URL	189
Using the Resync URL	190
Using the Reboot URL	190
Appendix B: SPA9000 Field Reference	191
Router Tab	191
Status page	191
Wan Setup page	193
Lan Setup page and Application page	196
Voice tab	197
Info page	197

System page	200
SIP Page	202
Provisioning page	224
Regional page	224
FXS 1/2 page	241
Line 1/2/3/4 page	251

Appendix C: SPA400 Field Reference 261

Setup	261
Basic Setup	262
SPA9000 Interface	262
Voice	264
Voicemail Server	268
Voicemail Users	269
Administration	270
Management	270
Factory Default	270
USB Setting	271
Firmware Upgrade	271
Reboot	271
Status	272
Gateway	272
Event Logs	273
Set Log Level	273
Tone	274

Appendix D: Where to Go From Here 275

Product Resources	275
Related Documentation	276

Appendix E: Glossary	278
Appendix F: Acronyms	281

About This Document

The *SPA9000 Voice System Administration Guide* is intended to help VARs and Service Providers to manage and configure the SPA9000 Voice System. This preface provides helpful information about this guide and other resources that are available to you. Before you begin to use this guide, refer to the following topics:

- “Purpose,” on page ix
- “Audience,” on page ix
- “Firmware,” on page x
- “Organization,” on page xi
- “Document Conventions,” on page xii
- “Finding Information in PDF Files,” on page xiii

Purpose

This document provides information that an administrator needs to configure the SPA9000 Voice System, which typically consists of a SPA9000 IP PBX, one or more SPA900 Series IP phones, and the optional SPA400 PSTN gateway and voice mail server. This guide focuses primarily on the tasks that an administrator performs to configure a SPA9000 with the SPA9000 administration web server.



NOTE This guide does not cover initial installation and configuration, SPA900 Series phone configuration, the Setup Wizard, or provisioning. See [“Related Documentation” in Appendix D, on page 276.](#)

Audience

This document is written for the following audience:

- Service providers offering services using Cisco SPA products
- VARs and resellers who need configuration references for Cisco SPA products

- System administrators or anyone who installs and administers the SPA9000 Voice System



NOTE This guide does not provide the configuration information required by specific service providers. Please consult with the service provider for specific service parameters.

Firmware

This guide describes the features that are available in the following firmware releases (and higher versions). You can find all available firmware updates by going to Cisco.com and choosing Support. Or visit the following URL and enter the model number in the Software Search box:

<http://tools.cisco.com/support/downloads>

Product	Firmware Version
SPA9000	6.1.5
SPA400	1.1.2.2
SPA901	5.1.5
SPA921/SPA941	5.1.8
SPA922/942	6.1.3
SPA962	6.1.3
WIP310	5.0.8

Organization

The information in this guide is organized into the following chapters and appendices:

Chapter	Description
Chapter 1, “Getting Started.”	This chapter introduces you to the SPA9000 Voice System by describing the components and presenting several deployment scenarios.
Chapter 2, “Basic Administration of the SPA9000.”	This chapter introduces you to basic administrative tasks using the SPA9000 administration web server and the Interactive Voice Response Unit.
Chapter 3, “Configuring Your System for ITSP Interoperability”	This chapter provides configuration details to help you to ensure that your infrastructure properly supports voice services.
Chapter 4, “Configuring Phone Lines and Calling Routing Behavior”	This chapter describes many features that you can configure on the SPA9000 to ensure smooth handling of all inbound and outbound calls, and ease of use.
Chapter 5, “Administering the SPA400 and Voice Mail Service”	This chapter guides you through the process of configuring and managing the SPA400 for PSTN access and voice mail service.
Chapter 6, “Configuring Music on Hold”	This chapter explains how to configure Music on Hold using either a music file or streaming audio.
Chapter 7, “Configuring the Auto Attendant”	This chapter describes how to configure the SPA9000 Voice System Auto Attendant (AA) by using the IVR and XML scripting.
Chapter 8, “Localization”	This chapter explains how to localize your SPA9000 Voice System with the language files, tones, and ring patterns for your region.
Appendix A, “Advanced Topics in SPA9000 Administration”	This appendix provides more detailed technical information for administrators who want to understand how the SPA9000 Voice System works.

Chapter	Description
Appendix B, “SPA9000 Field Reference”	This appendix describes the fields on each page of the SPA9000 administration web server.
Appendix C, “SPA400 Field Reference”	This appendix describes the fields on each page of the SPA400 administration web server.
Appendix D, “Where to Go From Here”	This appendix describes additional resources that are available to help you and your customer obtain the full benefits of the SPA9000 Voice System.
Appendix E, “Glossary” Appendix F, “Acronyms”	These resources help you to understand the terms and acronyms that are used in this guide.

Document Conventions

The following table describes the typographic conventions that are used in this document.

Typographic Element	Meaning
Boldface	May indicate either of the following: <ul style="list-style-type: none"> ▪ A user interface element that you need to click, select, or otherwise act on ▪ A literal value to be entered in a field.
<i>Italic</i>	May indicate either of the following: <ul style="list-style-type: none"> ▪ A variable that should be replaced with a literal value. ▪ The name of a page, section, or field in the user interface
Monospaced Font	Indicates code samples or system output.

Finding Information in PDF Files

The SPA9000 Voice System documents are published as PDF files. The PDF Find/Search tool within Adobe® Reader® lets you find information quickly and easily online. You can perform the following tasks:

- Search an individual PDF file.
- Search multiple PDF files at once (for example, all PDFs in a specific folder or disk drive).
- Perform advanced searches.

Finding Text in a PDF

Follow this procedure to find text in a PDF file.

STEP 1 Enter your search terms in the Find text box on the toolbar.



NOTE By default, the Find tool is available at the right end of the Acrobat toolbar. If the Find tool does not appear, choose **Edit > Find**.



STEP 2 Optionally, click the arrow next to the Find text box to refine your search by choosing special options such as Whole Words Only.

STEP 3 Press **Enter**.

STEP 4 Acrobat displays the first instance of the search term.

STEP 5 Press **Enter** again to continue to more instances of the term.

Finding Text in Multiple PDF Files

The *Search* window lets you search for terms in multiple PDF files that are stored on your PC or local network. The PDF files do not need to be open.

- STEP 1** Start Acrobat Professional or Adobe Reader.
- STEP 2** Choose **Edit > Search**, or click the arrow next to the *Find* box and then choose **Open Full Acrobat Search**.

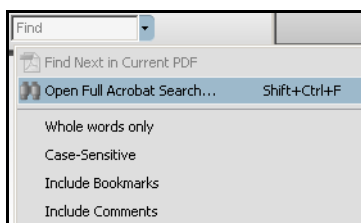

- STEP 3** In the *Search* window, complete the following steps:
- Enter the text that you want to find.
 - Choose **All PDF Documents in**.
From the drop-down box, choose **Browse for Location**. Then choose the location on your computer or local network, and click **OK**.
 - If you want to specify additional search criteria, click **Use Advanced Search Options**, and choose the options you want.
 - Click **Search**.

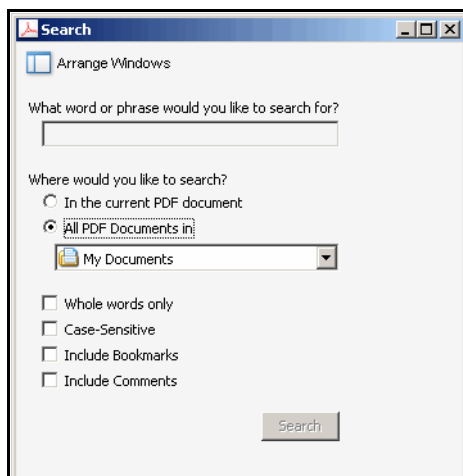

- STEP 4** When the Results appear, click + to open a folder, and then click any link to open the file where the search terms appear.

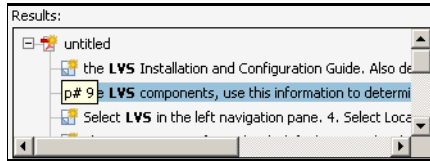

For more information about the Find and Search functions, see the Adobe Acrobat online help.

Getting Started

This chapter introduces you to the SPA9000 Voice System by describing the components and presenting several deployment scenarios.



NOTE This chapter is essential reading before you begin installing the equipment or configuring the system.

- “Introduction to the SPA9000 Voice System,” on page 16
- “Deployment Scenarios,” on page 18
- “Initial Installation, and Configuration,” on page 23

Introduction to the SPA9000 Voice System

The SPA9000 Voice System is an affordable and feature-rich IP telephone system that is designed especially for the Small and Home Office. The SPA9000 Voice System uses standard TCP/IP protocols and can provide global connectivity through any Internet Telephony Service Provider (ITSP) that supports the Session Initiation Protocol (SIP).

At minimum, the SPA9000 Voice System includes a SPA9000 IP PBX and one or more SPA900 series IP phones. These devices are connected through a switch to a local area network. With an Internet connection, the SPA9000 Voice System can subscribe to ITSP services to take advantage of low calling rates. With the SPA400, the SPA9000 Voice System can connect to the Public Switched Telephone Network (PSTN) to support analog phone lines. See [Figure 1 “SPA9000 Voice System with the SPA9000 and SPA400” on page 17](#) to learn more about a typical deployment.

Figure 1 SPA9000 Voice System with the SPA9000 and SPA400

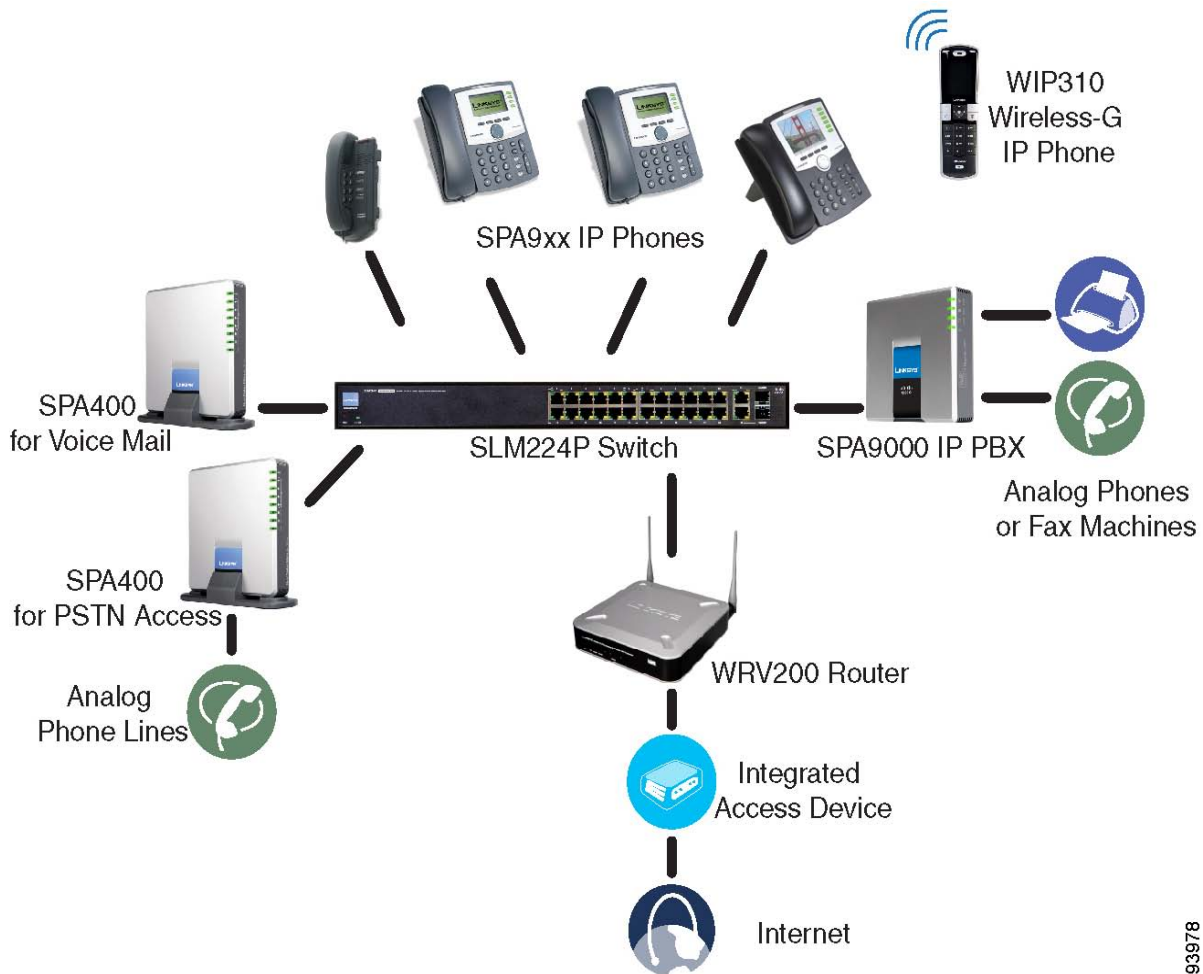

193978

SPA9000 IP PBX

The SPA9000 is an IP PBX that supports up to 16 phones. It also has a built-in Analog Telephone Adapter (ATA) with two FXS ports for analog telephones, fax devices, or an external music source for the music on-hold service. Devices connected to the FXS ports are not included in the device count.

The SPA9000 has four line interfaces, which can be configured in any combination for ITSP service, ISDN access, SPA400 PSTN access, or SPA400 voice mail service. A different ITSP account can be configured on each line interface. If a service provider supplies a group of sequential direct inward dial (DID) phone numbers (such as 408-555-0100 through 555-0145) the SPA9000 can support all of the assigned numbers on a single line interface.

The SPA9000 includes an Auto Attendant service that plays pre-recorded voice messages to offer the caller a menu of choices and to direct the call. When the Auto-Attendant is enabled, it parses and operates on user key presses according to the rules that are specified in the Auto Attendant script.

SPA400 SIP-PSTN Gateway and Voicemail Server

The SPA400 provides a SIP-PSTN gateway for voice connectivity between the PSTN and the local client stations that are connected to the SPA9000. It also includes an integrated voice mail application that supports up to 32 voice mail accounts with customized greetings, providing the ability to receive and playback voice mail messages.

Each SPA400 occupies one of the four line interfaces on the SPA9000. The SPA400 has four ports for that can be connected to PSTN or ISDN lines.

IP Phones and Accessories

The SPA9000 Voice System supports any of the Cisco SPA900 Series SIP IP Phones, as well as the Cisco WIP310 Wireless IP Phone.

**NOTE**

This guide explains how to configure the SPA9000 and the SPA400 to support the calling features on the phones. For more information about the phones, see the *SPA9x2 Phone Administration Guide*, the *SPA9x2 Phone User Guide*, and the *Cisco Wireless-G IP Phone User Guide*.

Deployment Scenarios

The SPA9000 Voice System can meet the calling needs of many small businesses. Various deployment scenarios are possible. This section includes the following examples:

- “PSTN Access and Local Voice Mail,” on page 19
- “ITSP Service Only,” on page 20
- “ITSP Service, PSTN Access and Local Voice Mail,” on page 21
- “ITSP Service, PSTN and ISDN Access and Local Voice Mail,” on page 22

PSTN Access and Local Voice Mail

In this scenario, the customer requires a robust phone system but is not using VoIP services. The SPA9000 Voice System is deployed with a SPA9000 IP PBX, one SPA400 for PSTN access with four FXO ports, and another SPA400 for local voice mail service. Up to 16 IP phones can be installed. Optionally, analog phones or fax machines (not illustrated) can be connected to the two phone ports on the SPA9000.

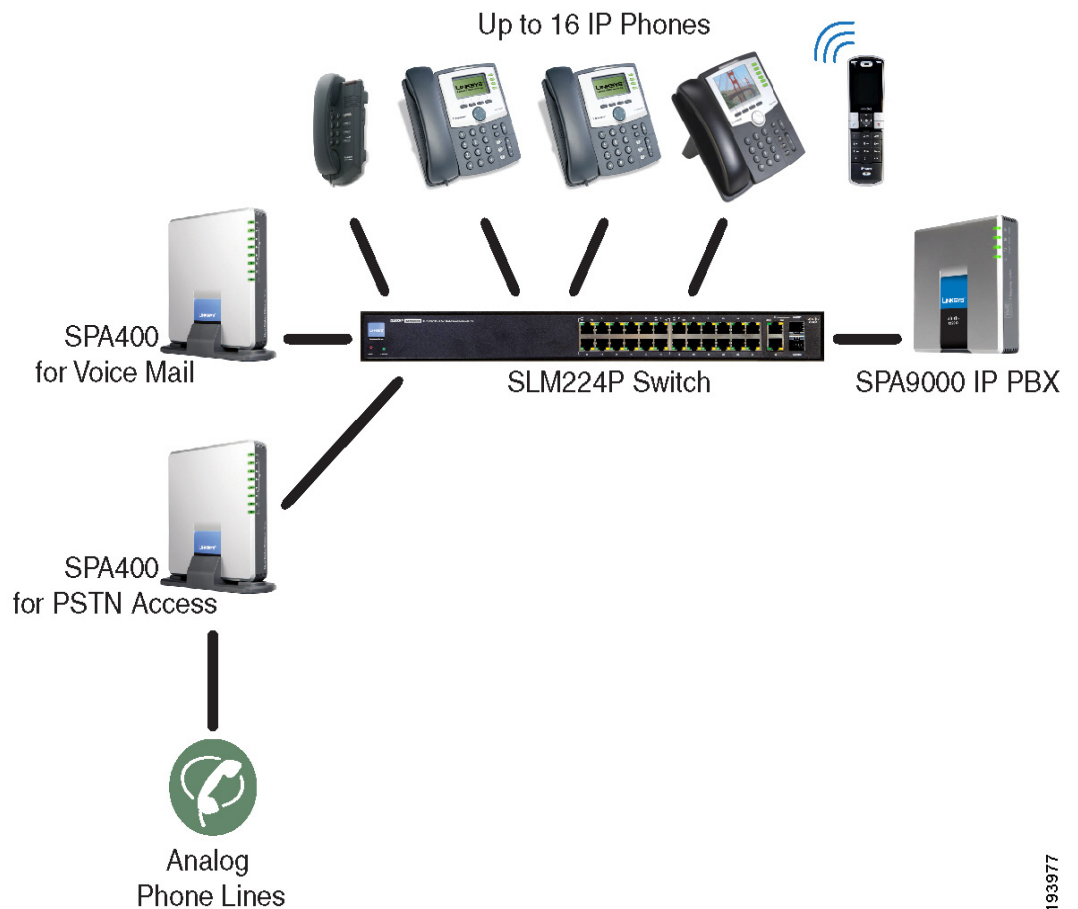

ITSP Service Only

In this scenario, a customer has no legacy telephone numbers and either needs no voice mail at all or has voice mail hosted by the ITSP. The SPA9000 Voice System is deployed with the SPA9000 IP PB and VoIP service. Up to 16 IP phones can be installed. Optionally, analog phones or fax machines (not illustrated) can be connected to the two phone ports on the SPA9000.



ITSP Service, PSTN Access and Local Voice Mail

In this scenario, the customer wants to use ITSP service for reduced long distance fees but needs to support legacy local telephone numbers (for example, to receive calls to a legacy telephone number or to place outbound calls in the local area). This customer also prefers local voice mail service. The SPA9000 Voice System is deployed with the SPA9000 IP PBX, VoIP service, one SPA400 unit for voice mail service, and another SPA400 unit for PSTN access with four FXO ports. Up to 16 IP phones can be installed. Optionally, analog phones or fax machines (not illustrated) can be connected to the two phone ports on the SPA9000.

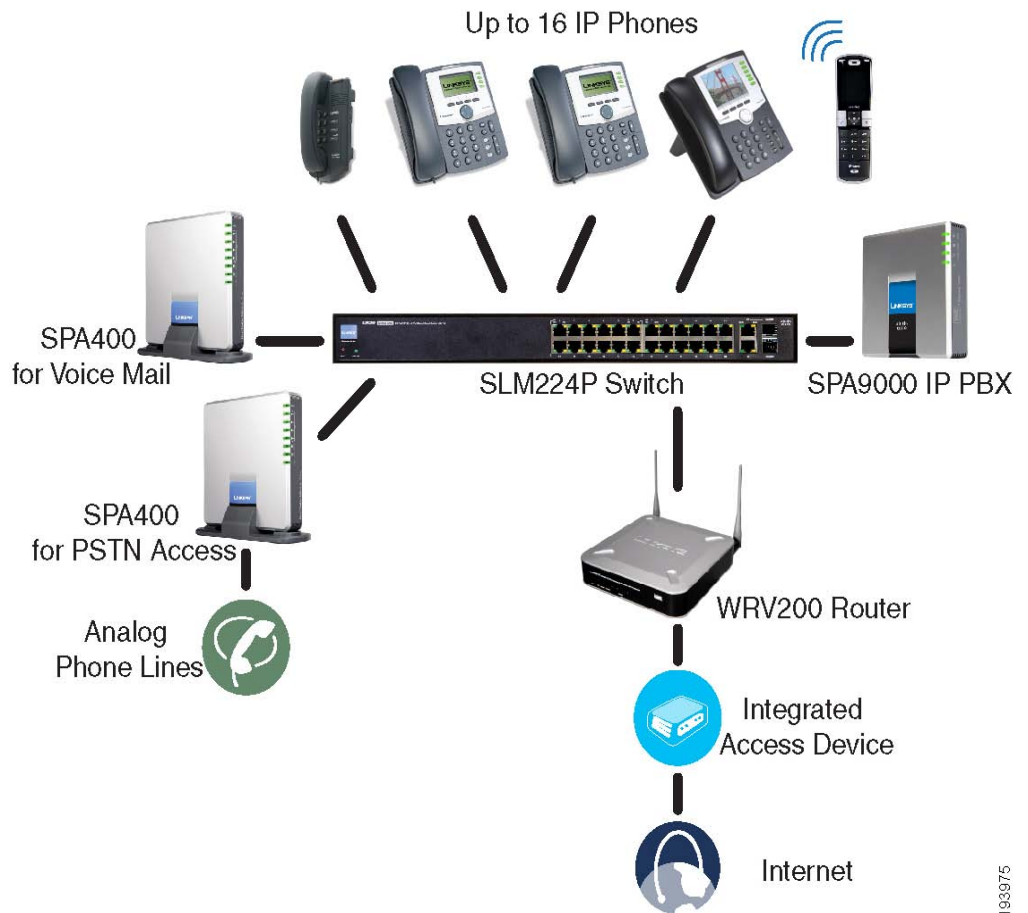

193975

ITSP Service, PSTN and ISDN Access and Local Voice Mail

In this scenario, the customer takes full advantage of the SPA9000 Voice System solution. This customer has the SPA9000 IP PBX, VoIP service, one SPA400 unit for voice mail service, and another SPA400 for PSTN access with four FXO ports. In addition, this installation includes an ISDN Gateway for ISDN BRI access with four BRI ports. Up to 16 IP phones can be installed. Optionally, analog phones or fax machines (not illustrated) can be connected to the two phone ports on the SPA9000.



193976

Initial Installation, and Configuration

Cisco strongly recommends that you use the *SPA9000 Voice System Installation and Configuration Guide* to design your system, to prepare the site, to connect and configure your equipment, and to set up the essential calling features. By following the instructions in the installation guide, you can get your system running in less time and with the settings that help to ensure strong performance.

After you complete the procedures in the installation guide, the users can make and receive calls. When the optional SPA400 is installed, the users also can record and retrieve voice mail messages. The SPA9000 has a fully functional Auto Attendant to greet callers, and a default dial plan that is suitable for most dialing scenarios. You can use this administration guide to refine the settings, to configure advanced features, and to manage the system.



NOTE

Because the *SPA9000 Voice System Installation and Configuration Guide* provides all of the procedures that you need for initial installation and configuration, those instructions are not duplicated in this administration guide.

Basic Administration of the SPA9000

This chapter introduces you to basic administrative tasks using the SPA9000 administration web server and the Interactive Voice Response Unit.



NOTE This administration guide does not cover the initial installation and configuration of the system. For information about connecting the equipment to start using your system, see the *SPA9000 Voice System Installation and Configuration Guide*.

See the following topics:

- “Upgrading Firmware for the SPA9000,” on page 25
- “Connecting to the SPA9000 Administration Web Server,” on page 27
- “Saving or Discarding Changes SPA9000,” on page 27
- “Access Levels,” on page 28
- “Setting Passwords for User and Administrator Accounts,” on page 29
- “Configuring Basic Settings,” on page 29
- “Viewing Information about the SPA9000,” on page 39
- “Viewing Information about Client Stations,” on page 39
- “Configuring Multicast Addressing and Group Paging,” on page 33
- “Using the Interactive Voice Response Unit,” on page 40

Upgrading Firmware for the SPA9000

As needed, you can download new firmware and then install it on the SPA9000.

- STEP 1** Download the latest SPA9000 firmware from the following URL:
<http://tools.cisco.com/support/downloads/go/Redirect.x?mdfid=282414116>
- STEP 2** Extract the Zip file, and then run the executable file to upgrade the firmware. When the *Firmware Upgrade Warning* window appears, click **Continue**.



- STEP 3** In the next window that appears, enter the IP address of the SPA9000, and then click **OK**.

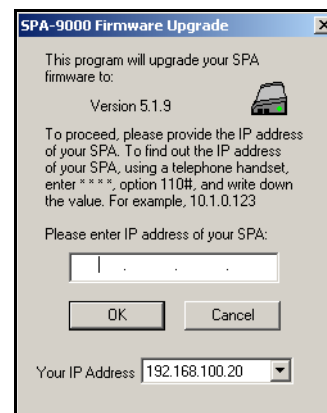

- STEP 4** In the *Confirm Upgrade* window, verify that the correct device information and product number appear. Then click **Upgrade**.

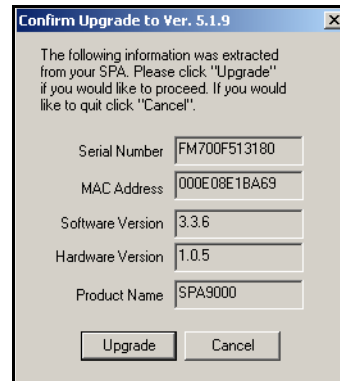

- STEP 5** When the confirmation message appears, click **OK**.

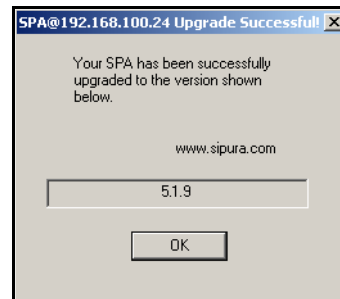

- STEP 6** To verify the upgrade, complete the following steps:
- Connect to the SPA9000 administration web server, and choose Admin access with Advanced settings. (See [“Connecting to the SPA9000 Administration Web Server,”](#) on page 27).
 - Review the *Router > Status* page. The *Software Version* field should show the firmware version that you installed.



NOTE You may need to refresh your browser to display the updated page reflecting the new version number.

Connecting to the SPA9000 Administration Web Server

To connect to the administration web server, perform the following steps.



NOTE You should have previously connected and configured the SPA9000 as described in the *SPA9000 Voice System Installation Guide*.

STEP 1 Start Internet Explorer on a computer that is on the same network as the SPA9000.

STEP 2 Enter the IP address of the SPA9000.



NOTE To find the IP address of the SPA9000, connect an analog telephone to the Phone 1 or Phone 2 port on the SPA9000. Then lift the receiver of the phone and press **** on the keypad to access the IVR menu. Press **110#** to hear the IP address.

STEP 3 To view administrative features, click **Admin Login** and then click **Advanced**. By default, no password is required. For more information, see [“Setting Passwords for User and Administrator Accounts,”](#) on page 29.

ALTERNATIVELY: After starting Internet Explorer, enter: `<SPA9000_ipaddress>/admin/advanced`

Saving or Discarding Changes SPA9000

Changes can be saved or discarded at any time.

- Changes are submitted only when you click the **Submit All Changes** button at the bottom of a page. When changes are saved, the SPA9000 may reboot, depending on the type of changes.
- To discard unsubmitted changes, click the **Undo All Changes** button at the bottom of the page.

- Unsubmitted changes are retained when you move among the pages within the Voice module or the Router module. This feature allows you to make changes on various pages within a module before clicking **Submit All Changes**.
- Unsubmitted changes are discarded when you switch between the Router and Voice tabs, between the User and Administrator accounts, or between the Basic and Advanced views.

Before you make changes, it is recommended that you save a copy of your current working configuration:

-
- STEP 1** In Internet Explorer, connect to the administration web server.
 - STEP 2** From the menu, choose **File > Save As**.
 - STEP 3** Save the configuration as Web Page Complete. You can use the saved file to review the saved settings in all pages of the administrative GUI.



NOTE To save a Telephone Configuration, first enter the IP address for the configuration, and then follow the above procedure.

Access Levels

You can use the SPA9000 administration web server to configure and manage your system. Three levels of access are available:

- **User Level:** The User account only has the privilege to access part of the web profile parameters.
- **Administrator Level:** The Administrator account has the privilege to modify all the web profile parameters and can also modify the passwords of both Administrator and User account.
- **Advanced:** Administrators and Users can view advanced features by clicking the Advanced link in the top right corner or lower left corner of the menu bar.

By default, no passwords are assigned for either the Administrator account or the User account. If the password has been set for the Administrator account, the browser prompts for authentication.

You can switch from User access to Administrator access by clicking the **Admin Login** link. Likewise, you can switch from Administrator access to User access by clicking the **User Login** link. If a password is set, you will be prompted to enter the password after you click the link.

Setting Passwords for User and Administrator Accounts

The Administrator account name for the SPA9000 is **admin** and the User account name is **user**. These account names are case sensitive and cannot be changed.



NOTE The system prompts for an Administrator account password only if a password has been set. By default, there is no password. You should set a password to protect your SPA9000 from unauthorized access.

- STEP 1** Connect to the SPA9000 administration web server, and choose Admin access with Advanced settings. (See “[Connecting to the SPA9000 Administration Web Server](#),” on page 27.)
- STEP 2** Click **Voice tab > System**.
- STEP 3** In the *System Configuration* section, enter the *Admin Password* and the *User Password*, as needed. Up to 39 characters are allowed for the passwords.
- STEP 4** Click **Submit All Changes**.

Configuring Basic Settings

This section provides information about the following tasks:

- “[Setting Up the WAN Connection for the SPA9000](#),” on page 30
- “[Setting the Date and Time](#),” on page 30
- “[Configuring Daylight Saving Time](#),” on page 31
- “[LAN and Application Guidelines](#),” on page 33

- “Configuring Multicast Addressing and Group Paging,” on page 33
- “Collecting System Logs and Debug Information,” on page 36

Setting Up the WAN Connection for the SPA9000

The SPA9000 becomes a DHCP client of any server on the network. The recommended setting is to use a static IP address. This configuration provides ease of installation and prevents connectivity issues that would occur if the IP address of the SPA9000 changed.

-
- STEP 1** Connect to the SPA9000 administration web server, and choose Admin access with Advanced settings. (See “[Connecting to the SPA9000 Administration Web Server](#),” on page 27.)
- STEP 2** Click **Router tab > Wan Setup**.
- STEP 3** From the *Connection Type* drop-down list, choose **Static IP**.
- STEP 4** In the *Static IP Settings* area, enter the Static IP of the SPA9000, as well as the *NetMask* and *Gateway* for your network.
- STEP 5** In the *Optional Settings* area, enter the Primary DNS for your network.



NOTE It is recommended to set an IP address that is outside the address range assigned by the DHCP server. For example, if the DHCP server assigns IP addresses in the range from 192.168.1.50 to 192.168.1.254, you should select a static IP address between 192.168.1.2 and 192.168.1.49.

- STEP 6** Click **Submit All Changes**. The SPA9000 reboots.
-

Setting the Date and Time

The date and time appear on the phone display and are used to activate the daytime and nighttime Auto Attendant settings. Normally the date and time are set by the network, which has a connection to an NTP server. If needed, you can identify the NTP server on the *Voice > Wan Setup* page, *Optional Settings* section.



NOTE Do not use the date/time settings on the *Voice > Regional* page to set your system time.

-
- STEP 1** Connect to the SPA9000 administration web server, and choose Admin access with Advanced settings. (See “[Connecting to the SPA9000 Administration Web Server](#),” on page 27).
- STEP 2** Click **Router tab > Wan Setup**.
- STEP 3** Scroll down to the *Optional settings* section.
- STEP 4** Enter the fully qualified domain name of the NTP server that you want to use, such as time.nist.gov.
- STEP 5** Click **Submit All Changes**.
- STEP 6** Click **Voice tab > Regional**.
- STEP 7** Scroll down to the *Miscellaneous* section.
- STEP 8** From the *Time Zone* drop-down list, choose your local time zone.
- STEP 9** Click **Submit All Changes**.
-

Configuring Daylight Saving Time

You can enter a daylight saving time rule to ensure that the time is adjusted appropriately for your region.

Syntax and Examples

SYNTAX: `start = <start-time>; end=<end-time>; save = <save-time>`

EXAMPLE: `start=3/9/7;end=11/2/7;save=1`

In this example, Daylight Saving Time begins March 9, 2007, and ends Nov. 2, 2007. One hour is added to the time of day during this period.

- `<start-time>`: The start date/time of daylight saving time
- `<end-time>`: The end date/time of daylight saving time

Enter these values in the following format: <month>/<day>/<weekday>[/ HH[:mm[:ss]]]

- <month>: 1-12 (January-December)
- <day>: 1-31
- <weekday>: Optional. If included, this value causes the rule to take effect on a particular day of the week before or after the specified date. Use the values 1-7 to represent the days Monday (1) through Sunday (7). Omit this parameter or enter 0 to cause the rule to take effect exactly on the specified date. If <weekday> is not 0 and the <day> value is positive, then daylight saving time starts or ends on <weekday> on or after the specified date. If <weekday> is not 0 and the <day> value is negative, then daylight saving time starts or ends on <weekday> on or before the specified date.
- HH:mm:ss: Optional. The time of day when the setting takes effect, in hours (0-23), minutes (0-59), and seconds (0-59)
- <save-time>: The number of hours (and optionally minutes and/or seconds) to add to the NTP server time during daylight saving time. Enter a negative (-) sign before <save-time> if subtraction is desired instead of addition.

Entering the Daylight Saving Time Rule

Follow this procedure to configure daylight saving time on your SPA9000 Voice System.

-
- STEP 1** Connect to the SPA9000 administration web server, and choose Admin access with Advanced settings. (See [“Connecting to the SPA9000 Administration Web Server,”](#) on page 27).
 - STEP 2** Click **Voice tab > Regional**.
 - STEP 3** Scroll down to the *Miscellaneous* section.
 - STEP 4** Enter the rule in the *Daylight Saving Time Rule* field.
 - STEP 5** Click **Submit All Changes**.
-

SPA9000 Ethernet Port

The SPA9000 Ethernet port is used to connect an administrative computer. Typically, this port is used only during initial installation and configuration. With WAN access enabled by default, you can manage your SPA9000 from any computer that is connected to the same subnetwork as the SPA9000. The default IP address for this port is 192.168.0.1.

LAN and Application Guidelines

Although the SPA9000 can provide router and application services, it does not have sufficient power to provide both phone and routing/application services in a highly utilized environment. For this reason, Linksys recommends that the SPA9000 not be used as a router at any time. Instead, use the SPA9000 as an appliance by connecting its INTERNET port to a network switch and leaving the ETHERNET port disconnected.

It is recommended that you leave the LAN and Application settings at the default values.

Configuring Multicast Addressing and Group Paging

For initialization and system updates, the SPA9000 communicates with all the client stations at once by using IP multicast. This method also is used in the group paging application. For this reason, the SPA9000 and the SPA9xx IP phones must reside on a network where multicasting is allowed. Default addresses are provided, but you can change these addresses as needed.



NOTE Make sure that the SPA9000 and the SPA900 Series phones use the same multicast address and port number. Also make sure that you enable spanning tree and port fast on your LAN switch, as described in the *SPA9000 Voice System Installation and Configuration Guide*.

Setting the Multicast Address

For administration purposes, the SPA9000 can send the following reboot, restart, page, and ring messages to the group:

- Graceful reboot: The device reboots when there are no calls in progress.
- Immediate reboot: The device reboots immediately.
- Graceful restart: The device restarts when there are no calls in progress.
- Immediate restart: The device restarts immediately.
- Group page start: One-way audio is sent from the caller to all other phones.
- Group page end: An active page is terminated.
- Get ringing calls: When a user chooses Group Pickup on a phone, the SPA9000 gathers information about all ringing phones and reports this information to the requesting phone.

- STEP 1** Connect to the SPA9000 administration web server, and choose Admin access with Advanced settings. (See “[Connecting to the SPA9000 Administration Web Server](#),” on page 27).
- STEP 2** Click **Voice tab > SIP**.
- STEP 3** Scroll down to the *PBX Parameters* section.
- STEP 4** Enter the correct multicast address in the *Multicast Address* field.

Voice tab > SIP > PBX Parameters Section

PBX Parameters			
Proxy Network Interface:	WAN	Proxy Listen Port:	6060
Multicast Address:	224.168.168.168:6061	Group Page Address:	224.168.168.168:3456
Max Expires:	60	Force Media Proxy:	yes
Proxy Debug Option:	none		
Call Routing Rule:	(<:L1>9xx. <:L2>8xx.)		
Call Park MOH Server:	imusic	Call Park DLG Refresh Intvl:	0
Default Group Line:	1,2,3,4	Group 1 User ID:	
Group 1 Line:		Group 2 User ID:	
Group 2 Line:		Group 3 User ID:	
Group 3 Line:		Group 4 User ID:	
Group 4 Line:			
Hunt Groups:	500:101,103,105,hunt=ra;10;1,cfwd=vm2100		
SIP DIDN Field:	TO UserID	SIP DIDN Param Name:	didn
Accept All MWI As Line:	Current	Phone DLG Refresh Intvl:	0



NOTE The default value is 224.168.168.168:6061.

STEP 5 Click **Submit All Changes**.

STEP 6 Enter the same multicast address in the phone configurations:

- a. Click the **PBX Status** link to view a list of all phones.
- b. Find the phone that you want to configure, and then click the hyperlink in the *IP Address* column. The *Telephone Configuration* page appears in a separate browser window.
- c. Click the **SIP** tab.
- d. Scroll down to the *Linksys Key System Parameters* section.
- e. Enter the IP address in the *Multicast Address* field.
- f. Click **Submit All Changes**.
- g. Click the **Back** button on the Internet Explorer toolbar to return to the list of phones.
- h. Repeat these steps for each phone.

Setting the Group Page Address

In the group paging application, the originator sends RTP packets to an IP multicast address at which all the other client stations are listening. This address is chosen by the SPA9000 and is configured on the *Voice > SIP* page, *PBX Parameters* section, *Group Page Address* field.

The originator starts the group page by choosing **PageGroup** from the Corporate Directory on the phone, or by using a speed dial or personal directory entry. All client stations are alerted at once. If the client station is on a call when a group page starts, the call is automatically placed on hold. The speaker on each paged station is turned on automatically unless the handset or headset is being used. Group page is one-way only. The paged client stations can only listen to the call from the originator.

STEP 1 Connect to the SPA9000 administration web server, and choose Admin access with Advanced settings. (See [“Connecting to the SPA9000 Administration Web Server,”](#) on page 27).

STEP 2 Click **Voice tab > SIP**.

STEP 3 Scroll down to the *PBX Parameters* section.

STEP 4 Enter the correct multicast address in the *Group Page Address* field.

Voice tab > SIP > PBX Parameters section

PBX Parameters			
Proxy Network Interface:	WAN	Proxy Listen Port:	6060
Multicast Address:	224.168.168.168:6061	Group Page Address:	224.168.168.168:3456
Max Expires:	60	Force Media Proxy:	yes
Proxy Debug Option:	none		
Call Routing Rule:	(<:L1>9xx. <:L2>8xx.)		
Call Park MOH Server:	imusic	Call Park DLG Refresh Intvl:	0
Default Group Line:	1,2,3,4	Group 1 User ID:	
Group 1 Line:		Group 2 User ID:	
Group 2 Line:		Group 3 User ID:	
Group 3 Line:		Group 4 User ID:	
Group 4 Line:			
Hunt Groups:	500:101,103,105,hunt=ra;10;1,cfwd=vm2100		
SIP DIDN Field:	TO UserID	SIP DIDN Param Name:	didn
Accept All MWI As Line:	Current	Phone DLG Refresh Intvl:	0



NOTE The default value is 224.168.168.168:34567.

STEP 5 Click **Submit All Changes**.

Collecting System Logs and Debug Information

If you are working with an ITSP that needs more information to configure interoperability, you can collect system logs and debug information for the SPA9000. You can send these logs to the ITSP for their use.

Requirements:

- You need a PC that is on the same subnetwork as the SPA9000, to capture the log files. This PC needs to be running a syslog daemon. Enter the IP address of this PC on the *Voice > System* page, in the *Syslog Server* and *Debug Server* fields.
- You can deploy a syslog server to receive syslog messages from the device, which acts as a syslog client. The syslog client device uses the syslog protocol to send messages, based on its configuration, to a syslog server. The syslog messages can be accessed by reviewing the "syslog.514.log" file which resides in the same directory as the slogsrv.exe syslog server application.

Partners can download the Syslog Server for SPA Devices by going to Cisco Partner Central, Voice & Conferencing page, Technical Resources section. Use the following URL:

[/www.cisco.com/web/partners/sell/smb/products/voice_and_conferencing.html#~vc_technical_resources](http://www.cisco.com/web/partners/sell/smb/products/voice_and_conferencing.html#~vc_technical_resources)



NOTE As a best practice, enable logging only when needed, and disable logging when you finish the investigation. Logging information can impact system performance.

STEP 1 Connect to the SPA9000 administration web server, and choose Admin access with Advanced settings. (See “[Connecting to the SPA9000 Administration Web Server](#),” on page 27).

STEP 2 Click **Voice tab > System**.

STEP 3 In the *Miscellaneous Settings* section, enter the following settings:

- **Syslog Server:** Enter the server IP address and port to collect basic information about system activity (no SIP messages).
- **Debug Server:** Enter the server IP address and port to collect information about SIP messages.



NOTE SIP logging is not enabled until you complete this procedure by enabling system logging on the line interface.

- **Debug Level:** Choose 3 to enable debugging.

STEP 4 Click **Voice tab > Line N**, where *N* represents the line interface number of the line that you are investigating.

STEP 5 Scroll down to the *SIP Settings* section, and then choose a **SIP Debug Option**, based on the level of SIP information that you want to collect.

Typically, your ITSP support personnel will tell you what type of information they need in the logs. The drop-down list includes three categories of options: none, 1-line, and full.

- none: Disables SIP logging

- **1-line:** Identifies the SIP message type but does not include the message body. Options within this category allow you to choose to exclude OPT (OPTIONS request/response), NTFY (NOTIFY request/response), and REG (REGISTER request/response) information to reduce the length of the logs.
- **full:** Includes the SIP message body. Options within this category allow you to choose to exclude OPT (OPTIONS request/response), NTFY (NOTIFY request/response), and REG (REGISTER request/response) information to reduce the length of the logs.

EXAMPLES:

- If you are troubleshooting a problem with line registration, select **full** to include the OPTION, NOTIFY, and REGISTER information in the logs.
- If you are troubleshooting a call problem, select **full excl. OPTINTFYIREG**. You do not need the OPT, Notify, and Registration information to troubleshoot a call problem.

STEP 6 Click **Submit All Changes**. The information is stored on the specified server and port, with a file name in the following format: `syslog.port.log`.

- STEP 7** **IMPORTANT:** When you finish collecting the information, disable the logging:
- a. Click **Voice tab > Line**. Change **SIP Debug Option** to **none**.
 - b. Click **Voice tab > System**. In the *Miscellaneous Settings* section, change **Debug Level** to **0**.

Viewing Information about the SPA9000

The *Router Status* page provides information about software version, hardware version, MAC address, WAN connection type, IP address, and the packets that have been sent and received.

SPA9000 Router > Status

Router		Voice	
Status	Wan Setup	Lan Setup	Application
			PBX Status
			User Login basic advanced
Product Information			
Product Name:	SPA9000	Serial Number:	FM700F513180
Software Version:	5.1.9	Hardware Version:	1.0.5
MAC Address:	000E08E1BA69	Client Certificate:	Installed
Customization:	Open	Licenses:	K0
System Status			
Current Time:	3/26/2008 05:53:59	Elapsed Time:	1 day and 00:37:20
Wan Connection Type:	Static IP	Current IP:	192.168.0.109
Host Name:	SipuraSPA	Domain:	
Current Netmask:	255.255.255.0	Current Gateway:	192.168.0.1
Primary DNS:	192.168.0.1		
Secondary DNS:			
LAN IP Address:	192.168.1.1	Broadcast Pkts Sent:	0
Broadcast Bytes Sent:	0	Broadcast Pkts Recv:	25633
Broadcast Bytes Recv:	8006598	Broadcast Pkts Dropped:	0
Broadcast Bytes Dropped:	0		
Undo All Changes		Submit All Changes	

Viewing Information about Client Stations

The *PBX Status* page provides information about the client stations (IP phones), with hyperlinks to station configuration pages.

- STEP 1** Connect to the SPA9000 administration web server, and choose Admin access with Advanced settings. (See “[Connecting to the SPA9000 Administration Web Server](#),” on page 27).
- STEP 2** To view the status information for the client stations, click the **PBX Status** link in the top right corner or lower left corner of the page. The list of client stations appears.

SPA9000 > PBX Status

Registration	Station	User ID	IP Address	Reg Expires(s)	User-Agent
<input type="checkbox"/>	Sales1	100	192.168.1.137	71	Linksys/SPA942-5.2.8
<input type="checkbox"/>	Sales2	101	192.168.1.134	75	Linksys/SPA942-5.2.8
<input type="checkbox"/>	Accounting	103	192.168.1.107	72	Linksys/SPA942-5.2.8
<input type="checkbox"/>	CustomerSupport	105	192.168.1.105	72	Linksys/SPA942-5.2.8

-
- STEP 3** To view the *Telephone Configuration* page for any station, click the hyperlink in the *IP Address* column. For information about the telephone configurations, see the *Linksys Phone Administration Guide*.
-

Using the Interactive Voice Response Unit

In addition to the administration web server, the SPA9000 is equipped with an Interactive Voice Response unit (IVR) that allows you to perform certain administrative tasks by using an analog phone that is connected to the SPA9000.

- “Using the IVR Menu,” on page 40
- “Entering a Password through the IVR,” on page 45

Using the IVR Menu

To use the IVR menu, complete the following steps.

-
- STEP 1** Connect an analog telephone to the Phone 1 or Phone 2 port of the SPA9000.
- STEP 2** Press **** (quickly press the star key four times).
- STEP 3** Wait until you hear “Linksys configuration menu.”
- STEP 4** Refer to [Table 1 ‘IVR Options’ on page 41](#) to identify the required option.
- STEP 5** Enter the required option followed by the # (pound) key.
- To enter a period, use the star key (*).
 - When entering a value, such as an IP address, to exit without entering any changes, press the * (star) key twice within half a second. Otherwise, the * is treated as a decimal point.
 - After entering a value, such as an IP address, press the # (pound) key to indicate you have finished your selection.
 - To save a new setting, press **1**. To review a new setting, press **2**. To re-enter a setting, press **3**. To cancel your entry and return to the main menu, press * (star).

For example, to enter the IP address *191.168.1.105* by keypad, press the following keys: **191*168*1*105**. Press the # (pound) key to indicate that you have finished entering the IP address. Then press **1** to save the IP address, or press the * (star) key to cancel your entry and return to the main menu.

- If the menu is inactive for more than one minute, the SPA9000 times out. You need to re-enter the menu by pressing ****.

STEP 6 To exit the menu, hang up the telephone.

The settings that you have saved take effect after you hang up the telephone. The SPA9000 may reboot at this time.

Table 1 IVR Options

The following table shows the codes that you enter to complete various tasks in the IVR.

IVR Action	IVR Menu Choice	Parameters	Notes
Enter IVR Menu	* * * *	None	Ignore SIT or other tones until you hear, "Linksys configuration menu. Please enter option followed by the pound key or hang-up to exit."
Exit IVR Menu	3948	None	
Check DHCP	100	None	The IVR spells "S,T,A,T,I,C" if the setting is for a static IP address or "D,H,C,P" for a DHCP IP address.
Enable/Disable DHCP	101	Enter 0 to enable Enter 1 to disable	Requires password
Check WAN IP Address	110	None	IVR announces the current IP address of the WAN port.

IVR Action	IVR Menu Choice	Parameters	Notes
Set Static IP Address	111	Enter IP address using numbers on the telephone key pad. Use the * (star) key when entering a decimal point.	DHCP must be disabled first, or this value is considered an “Invalid Option.” Hang up the phone after setting the IP address. The SPA9000 reboots and the new address takes effect. Do not attempt to use IVR option 110 immediately after changing the IP address. The old IP address is reported until the SPA9000 reboots. Requires password
Check Network Mask	120	None	IVR announces the current network mask of SPA.
Set Network Mask	121	Enter value using numbers on the telephone key pad. Use the * (star) key when entering a decimal point.	DHCP must be disabled first, or this value is considered an “Invalid Option.” Requires password
Check Static Gateway IP Address	130	None	IVR announces the current gateway IP address of SPA.
Set Static Gateway IP Address	131	Enter IP address using numbers on the telephone key pad. Use the * (star) key when entering a decimal point.	DHCP must be “Disable,” otherwise you hear, “Invalid Option,” if you try to set this value. Requires password
Check MAC Address	140	None	IVR announces the MAC address of SPA in hex string format.

IVR Action	IVR Menu Choice	Parameters	Notes
Check Firmware Version	150	None	IVR announces the version of the firmware running on the SPA.
Check Primary DNS Server Setting	160	None	IVR announces the current setting in the <Primary DNS> parameter.
Set Primary DNS Server	161	Enter IP address using numbers on the telephone key pad. Use the * (star) key when entering a decimal point.	Requires password
Check administration web server port	170	None	IVR announces the port that the web server is listening on. (Default is 80.)
Check LAN IP Address	210	None	IVR announces the current IP address of the LAN port.
Check PBX multicast address	180	None	IVR announces the current value.
Set PBX multicast address	181	Enter IP address and port. Use * key for entering a dot. For example, 224.168.168.169:8089 is 224*168*168*169*8089.	Enter a * between the IP address and the Port fields. Requires Password
Enable/Disable administration web server	7932	Enter 1 to enable Enter 0 to disable	Requires password

IVR Action	IVR Menu Choice	Parameters	Notes
Manage the Auto Attendant Messages	72255	Enter the message number, followed by the pound key. Then enter 1 to record, 2 to review, 3 to review, or * to exit.	For more information, see Chapter 7, “Configuring the Auto Attendant.”
Manual Reboot of Unit	732668	None	After you hear “Option Successful,” hang up. Unit reboots automatically.
User Factory Reset of Unit WARNING: ALL “User-Changeable” NON-DEFAULT SETTINGS WILL BE LOST! This might include network and service provider data.	877778	Enter 1 to confirm Enter *(star) to cancel operation	SPA prompts for confirmation. After confirming, you hear “Option Successful.” Hang up. Unit reboots and all “User Changeable” configuration parameters are reset to factory default values.
Factory Reset of Unit WARNING: ALL NON-DEFAULT SETTINGS WILL BE LOST! This includes network and service provider data.	73738	Enter 1 to confirm Enter * (star) to cancel operation	SPA prompts for confirmation. After confirming, you hear “Option Successful.” Hang up. Unit reboots and all configuration parameters are reset to factory default values.



NOTE The items marked with “Requires Password” only require a password if the Administrator password is set.

Entering a Password through the IVR

To input the password using the phone keypad, the following translation conventions apply:

- To input: A, B, C, a, b, c—press “2’
- To input: D, E, F, d, e, f—press “3’
- To input: G, H, I, g, h, i—press “4’
- To input: J, K, L, j, k, l—press “5’
- To input: M, N, O, m, n, o—press “6’
- To input: P, Q, R, S, p, q, r, s—press “7’
- To input: T, U, V, t, u, v—press “8’
- To input: W, X, Y, Z, w, x, y, z—press “9’
- To input all other characters in the Administrator account password, press “0’

For example, to input password **test#@1234** by phone keypad, you need to press the following sequence of digits: **8378001234**. This translation convention only applies to the password input.

STEP 1 After entering a value, press the # (pound) key to indicate end of input.

- To save value, press **1**.
- To review the value, press **2**.
- To re-enter the value, press **3**.
- To cancel the value entry and return to the main configuration menu, press ***** (star).

- The final # key is not included in the password value.
- Saved settings take effect when the telephone is hung-up, and if necessary, the SPA9000 automatically reboots.

STEP 2 After one minute of inactivity, the unit times out. The user needs to re-enter the configuration menu from the beginning by pressing * * * *.

Configuring Your System for ITSP Interoperability

This chapter provides configuration details to help you to ensure that your infrastructure properly supports voice services.

- [“About the SPA9000 Voice System and SIP,” on page 47](#)
- [“Network Address Translation \(NAT\) and Voice over IP \(VoIP\),” on page 49](#)
- [“Firewalls and SIP,” on page 54](#)
- [“Configuring SIP Timer Values,” on page 55](#)

About the SPA9000 Voice System and SIP

The SPA9000 Voice System is implemented using open standards, such as Session Initiation Protocol (SIP), to help ensure interoperability with all ITSPs that support SIP. This section provides information about the SIP requests and the settings that you may need to adjust on your network or your SPA9000 to help ensure interoperability.

The VoIP telephone service is coordinated by SIP requests and responses, whether the calls are internal or external. [Figure 1, “SIP Requests and Responses for Internal Calls,” on page 48](#) illustrates the SIP requests and responses between client stations in the SPA9000 Voice System. The SPA9000 acts as a SIP proxy and establishes a session. After the session is established, Real Time Protocol (RTP) traffic flows directly between the two client stations.

Figure 1 SIP Requests and Responses for Internal Calls

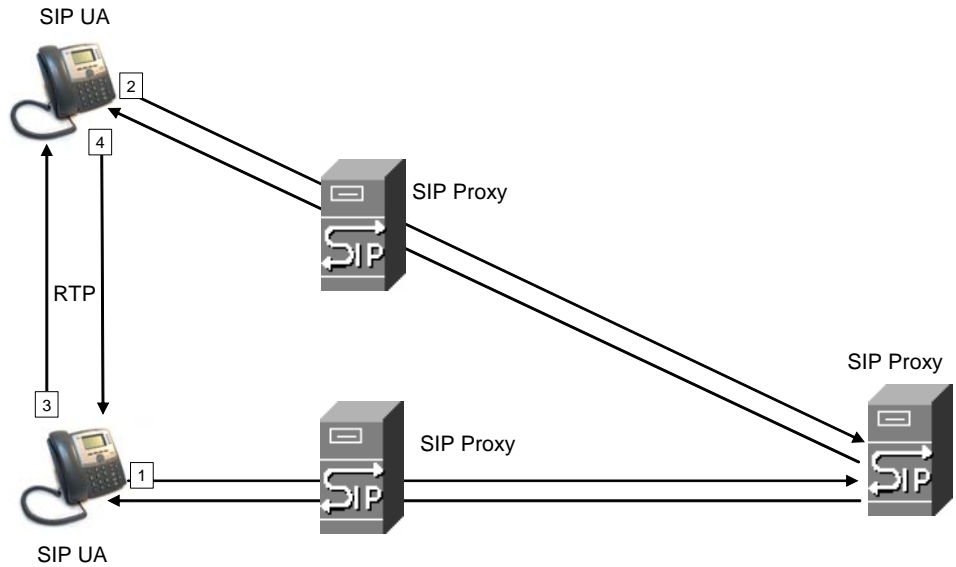

Likewise, SIP requests and responses are exchanged to support outbound and inbound calls that are handled through the ITSP service. In [Figure 2, “SPA9000 as a SIP Proxy for Internet Calls,”](#) UserA and UserB are client stations that are registered to the SPA9000. When UserA calls UserC, the SPA9000 directs the request to the SIP proxy at the ITSP, which is then responsible for routing the request to UserC. After the session is established, RTP is anchored by the SPA9000.

Figure 2 SPA9000 as a SIP Proxy for Internet Calls

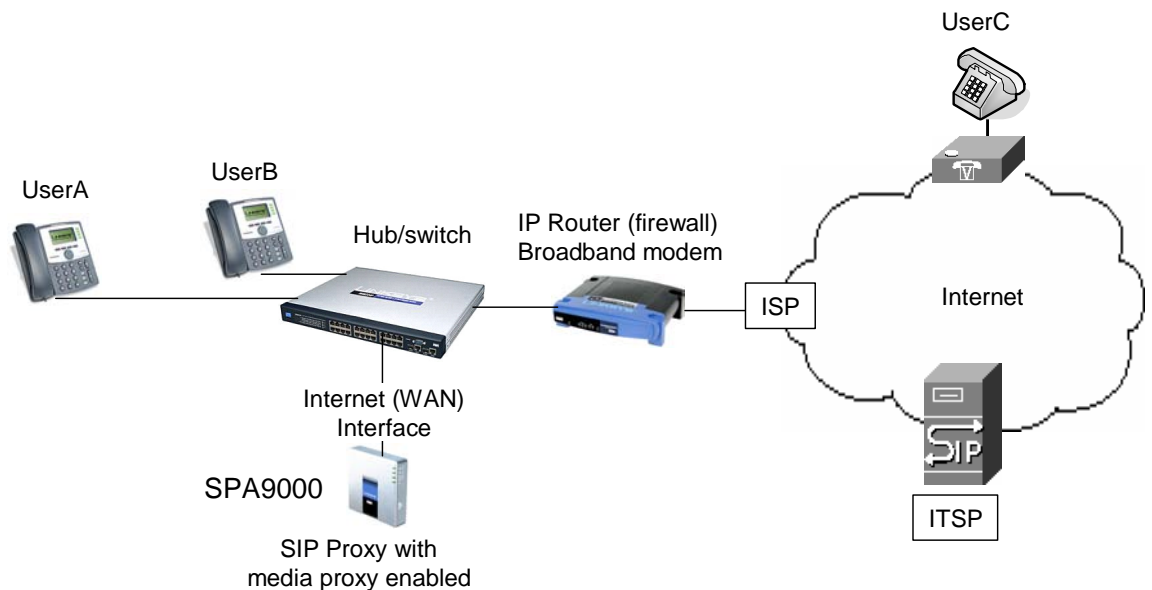

Network Address Translation (NAT) and Voice over IP (VoIP)

NAT is a function that allows multiple devices to share the same public, routable, IP address to establish connections over the Internet. NAT is present in many broadband access devices to translate public and private IP addresses. To enable VoIP to co-exist with NAT, some form of NAT traversal is required.

Some ITSPs provide NAT traversal, but some do not. If your ITSP does not provide NAT traversal, you have several options.

- [“NAT Mapping with Session Border Controller,” on page 49](#)
- [“NAT Mapping with SIP-ALG Router,” on page 49](#)
- [“Configuring NAT Mapping with a Static IP Address,” on page 49](#)
- [“Configuring NAT Mapping with STUN,” on page 51](#)

NAT Mapping with Session Border Controller

It is strongly recommended that you choose an ITSP that supports NAT mapping through a Session Border Controller. With NAT mapping provided by the ITSP, you have more choices in selecting a router.

NAT Mapping with SIP-ALG Router

If the ITSP network does not provide a Session Border Controller functionality, you can achieve NAT mapping by using a router that has a SIP ALG (Application Layer Gateway). The WRV200 router is recommended for this purpose, although any router with a SIP-ALG can be used. By using a SIP-ALG router, you have more choices in selecting an ITSP.

Configuring NAT Mapping with a Static IP Address

If the ITSP network does not provide a Session Border Controller functionality, and if other requirements are met, you can configure NAT mapping to ensure interoperability with the ITSP.

Requirements:

- You must have an external (public) IP address that is static.
- The NAT mechanism used in the router must be symmetric. See [“Determining Whether the Router Uses Symmetric or Asymmetric NAT,”](#) on page 53.
- The LAN switch must be configured to enable Spanning Tree Protocol and Port Fast on the ports to which the SPA devices are connected.



NOTE Use NAT mapping only if the ITSP network does not provide a Session Border Controller functionality.

STEP 1 Connect to the administration web server, and choose Admin access with Advanced settings.

STEP 2 Click **Voice tab > SIP**.

STEP 3 Scroll down to the *NAT Support Parameters* section, and then enter the following settings to support static mapping to your public IP address:

- **Handle VIA received, Insert VIA received, Substitute VIA Addr:** yes
- **Handle VIA rport, Insert VIA rport, Send Resp To Src Port:** yes
- **EXT IP:** Enter the public IP address for your router.

Voice tab > SIP: NAT Support Parameters

NAT Support Parameters			
Handle VIA received:	yes	Handle VIA rport:	yes
Insert VIA received:	yes	Insert VIA rport:	yes
Substitute VIA Addr:	yes	Send Resp To Src Port:	yes
STUN Enable:	no	STUN Test Enable:	no
STUN Server:		EXT IP:	xxx.xxx.xxx.xxx
EXT RTP Port Min:		NAT Keep Alive Intvl:	15

STEP 4 Click **Voice tab > Line N**, where *N* represents the line interface number.

STEP 5 Scroll down to the *NAT Settings* section.

- **NAT Mapping Enable:** Choose **YES**.
- **NAT Keep Alive Enable:** Choose **YES** (optional).

Voice tab > Line N > NAT Settings

NAT Settings			
NAT Mapping Enable:	yes	NAT Keep Alive Enable:	yes
NAT Keep Alive Msg:	\$NOTIFY	NAT Keep Alive Dest:	\$PROXY

STEP 6 Click **Submit All Changes**.



NOTE You also need to configure the firewall settings on your router to allow SIP traffic. See “[Firewalls and SIP](#),” on page 54.

Configuring NAT Mapping with STUN

If the ITSP network does not provide a Session Border Controller functionality, and if other requirements are met, it is possible to use STUN as a mechanism to discover the NAT mapping. This option is considered a practice of last resort and should be used only if the other methods are unavailable.

Requirements:

- STUN is a viable option only if your router uses asymmetric NAT. See “[Determining Whether the Router Uses Symmetric or Asymmetric NAT](#),” on page 53.
- You must have a computer running STUN server software.
- The LAN switch must be configured to enable Spanning Tree Protocol and Port Fast on the ports to which the SPA devices are connected.



NOTE Use NAT mapping only if the ITSP network does not provide a Session Border Controller functionality.

STEP 1 Connect to the administration web server, and choose Admin access with Advanced settings.

STEP 2 Click **Voice tab > SIP**.

STEP 3 Scroll down to the *NAT Support Parameters* section, and then enter the following settings to enable and support the STUN server settings:

- **Handle VIA received:** yes
- **Handle VIA rport:** yes
- **Insert VIA received:** yes
- **Insert VIA rport:** yes
- **Substitute VIA Addr:** yes
- **Send Resp To Src Port:** yes
- **STUN Enable:** Choose **yes**.
- **STUN Server:** Enter the IP address for your STUN server.

Voice tab > SIP > NAT Support Parameters

NAT Support Parameters			
Handle VIA received:	yes	Handle VIA rport:	yes
Insert VIA received:	yes	Insert VIA rport:	yes
Substitute VIA Addr:	yes	Send Resp To Src Port:	yes
STUN Enable:	yes	STUN Test Enable:	no
STUN Server:	xxx.xxx.xxx.xxx	EXT IP:	
EXT RTP Port Min:		NAT Keep Alive Intvl:	15

STEP 4 Click **Voice tab > Line N**, where N is the number of the line interface.

STEP 5 Scroll down to the *NAT Settings* section.

- **NAT Mapping Enable:** Choose **yes**.
- **NAT Keep Alive Enable:** Choose **yes** (optional).

Voice tab > Line N > NAT Settings

NAT Settings			
NAT Mapping Enable:	yes	NAT Keep Alive Enable:	yes
NAT Keep Alive Msg:	\$NOTIFY	NAT Keep Alive Dest:	\$PROXY



NOTE Your ITSP may require the SPA device to send NAT keep alive messages to keep the NAT ports open permanently. Check with your ITSP to determine the requirements.

STEP 6 Click **Submit All Changes**.



NOTE You also need to configure the firewall settings on your router to allow SIP traffic. See “[Firewalls and SIP](#),” on page 54.

Determining Whether the Router Uses Symmetric or Asymmetric NAT

STUN does not work on routers with symmetric NAT. With symmetric NAT, IP addresses are mapped from one internal IP address and port to one external, routable destination IP address and port. If another packet is sent from the same source IP address and port to a different destination, then a different IP address and port number combination is used. This method is restrictive because an external host can send a packet to a particular port on the internal host *only if* the internal host first sent a packet from that port to the external host.



NOTE This procedure assumes that a syslog server is configured and is ready to receive syslog messages.

STEP 1 Make sure you do not have firewall running on your PC that could block the syslog port (port 514 by default).

STEP 2 Connect to the administration web server, and choose Admin access with Advanced settings.

STEP 3 To enable debugging, complete the following tasks:

- a. Click **Voice tab > System**.
- b. In the *Debug Server* field, enter the IP address of your syslog server. This address and port number must be reachable from the SPA9000.
- c. From the *Debug level* drop-down list, choose **3**.

-
- STEP 4** To collect information about the type of NAT your router is using, complete the following tasks:
- Click **Voice tab > SIP**.
 - Scroll down to the *NAT Support Parameters* section.
 - From the *STUN Test Enable* field, choose **yes**.
- STEP 5** To enable SIP signalling, complete the following task:
- Click **Voice tab > Line *N***, where *N* represents the line interface number.
 - In the *SIP Settings* section, choose **full** from the *SIP Debug Option* field.
- STEP 6** Click **Submit All Changes**.
- STEP 7** View the syslog messages to determine whether your network uses symmetric NAT. Look for a warning header in the REGISTER messages, such as Warning: 399 spa "Full Cone NAT Detected."
-

Firewalls and SIP

To enable SIP requests and responses to be exchanged with the SIP proxy at the ITSP, you must ensure that your firewall allows both SIP and RTP unimpeded access to the Internet.

- Make sure that the following ports are not blocked:
 - SIP ports—UDP port 5060 through 5063, which are used for the ITSP line interfaces
 - RTP ports—16384 to 16482
- Also disable SPI (Stateful Packet Inspection) if this function exists on your firewall.

Configuring SIP Timer Values

The default timer values should be adequate in most circumstances. However, you can adjust the SIP timer values as needed to ensure interoperability with your ISTP. For example, if SIP requests are returned with an “invalid certificate” message, you may need to enter a longer SIP T1 retry value.

To view the default settings or to make changes, open the *Voice > SIP* page, and scroll down to the *SIP Timer Values* section. .

Configuring Phone Lines and Calling Routing Behavior

This chapter describes many features that you can configure on the SPA9000 to ensure smooth handling of all inbound and outbound calls, and ease of use.

- “Configuring SPA9000 FXS Ports,” on page 57
- “Configuring Line Interfaces on the SPA9000,” on page 58
- “Configuring Dial Plans,” on page 66
- “Managing the Line Selection for Outbound Calls,” on page 78
- “Managing Caller ID Settings for Outgoing Calls,” on page 82
- “Call Forwarding Support on SPA9000,” on page 82
- “Call Transfer Support on SPA9000,” on page 84
- “Managing Inbound Calls with the Contact List,” on page 85
- “Managing Inbound Calls with Hunt Groups,” on page 92
- “Managing Inbound Calls with Shared Line Appearances,” on page 98

Configuring SPA9000 FXS Ports

The SPA9000 FXS ports can be used to connect analog phones and fax machines to the SPA9000 Voice System. A port also can be configured for a Streaming Audio Server for Music On Hold. See [Chapter 6, “Configuring Music on Hold.”](#)



NOTE A fax machine can be connected to the Phone port of the SPA9000. Fax support through an ITSP line requires a T.38 fax machine on both ends and the availability of T.38 FAX relay through the ITSP. T.38 support is dependent on fax machine and network / transport resilience. Linksys makes no guarantee with the use of this product regarding fax transmission services

-
- STEP 1** Start Internet Explorer, and then enter the IP address of the SPA9000. Click **Admin Login** and then click **Advanced**.
- STEP 2** Click **Voice tab > FXS N**, where N is the port number.
- STEP 3** Scroll down to the *Subscriber Information* section, and then enter the following settings:
- **Display Name:** Enter an extension number of name for the FXS 1 port, such as Receptionist Area Fax Machine. You can use this extension number to add the analog phone to the contact list, hunt groups, and shared line appearances.
 - **User ID:** Enter a three- to four-digit extension number that is not is use by other extension.
 - If the device is a fax machine, disable echo cancelling. On the *FXS N* page, *Audio Configuration* section, set the *FAX Disable ECAN* field to **yes**. Also make sure that the *Preferred Codec* is set to **G.711u** (default setting).
- STEP 4** Enter the *Dial Plan* settings, as needed. See [“Configuring Dial Plans,” on page 66.](#)
- STEP 5** Click **Submit All Changes**.
-

Configuring Line Interfaces on the SPA9000

You can configure the following types of services on the SPA9000 line interfaces:

- **ITSP service:** Up to 16 DID numbers can be supported on each line interface. You can configure different ITSP accounts on different line interfaces.
- **PSTN service:** You can configure a line interface to register the SPA9000 with a SPA400 to support PSTN lines.
- **SPA400 voice mail service:** You can configure a line interface to register the SPA9000 with a SPA400 to support voice mail server. This SPA400 should have no more than two PSTN lines connected. If more than two PSTN lines and voice mail are required, you should reserve one SPA400 exclusively for voice mail. Exceeding these guidelines will affect the quality of voice mail playback and command recognition.
- **ISDN services:** You can configure a line interface to register the SPA9000 with a Mediatrix® 4400 ISDN BRI Digital gateway. For more information, refer to the *SPA9000/Mediatrix® 440X ISDN Gateway Configuration Guide*. Partners can find this guide by going to Cisco Partner Central, Voice & Conferencing page, Technical Resources section. Use the following URL:
www.cisco.com/web/partners/sell/smb/products/voice_and_conferencing.html#~vc_technical_resources

This section includes the following topics:

- “Configuring a Line Interface for ITSP Service,” on page 58
- “Configuring a Line Interface for a SPA400 (PSTN or Voice Mail),” on page 60
- “Configuring Call Capacity for a Line Interface,” on page 63

Configuring a Line Interface for ITSP Service

-
- STEP 1** Start Internet Explorer, and then enter the IP address of the SPA9000. Click **Admin Login** and then click **Advanced**.
- STEP 2** Click **Voice tab > Line N**, where *N* represents the line interface number.
- STEP 3** From the *Line Enable* drop-down list, choose **yes**.

STEP 4 Enter the account information for your ITSP account:

- **User ID:** The account number or logon name for your ITSP account (often the same as the phone number)
- **Password:** The password for your ITSP account
- **Proxy:** The proxy server for your ITSP account

SPA9000 Voice > Line

Subscriber Information	
Display Name:	User ID: 19725550100
Password: *****	Use Auth ID: no
Auth ID:	Call Capacity: unlimited
Contact List: 100,103	
Cfwd No Ans Delay: 20	
Dial Plan	
Dial Plan:	(<9:>xx.)
NAT Settings	
NAT Mapping Enable: no	NAT Keep Alive Enable: no
NAT Keep Alive Msg: \$NOTIFY	NAT Keep Alive Dest: \$PROXY
EXT SIP Port:	
Proxy and Registration	
Proxy:	newyork-1.vtnoc.net

- **SIP Port:** You can keep the default value. Each line must have a unique SIP port (5060 for Line 1, 5061 for Line 2, 5062 for Line 3, 5064 for Line 4).
- **Contact List:** The default value is aa, for the Auto Attendant. As a general practice, you should leave the default value until after you confirm that the line is registered. Then you can configure the contact list. For more information, see [“Managing Inbound Calls with the Contact List,” on page 85.](#)
- Depending on your ITSP network configuration requirements, you may need to set additional parameters such as Outbound Proxy. Service Provider will indicate the setting of any additional parameter for each ITSP line.

STEP 5 Click **Submit All Changes**. The SPA9000 device reboots.

STEP 6 To verify the registration state, perform the following tasks:

- After the devices reboot, Click **Voice tab > Info**. Scroll down to the *Line Status* section for the line that you configured (*Line 1 Status... Line 4 Status*). Verify that the line is registered. If the line is not registered, you may need to refresh the browser several times because it can take a few seconds for the registration to succeed.

SPA9000 Voice > Info > Line Status

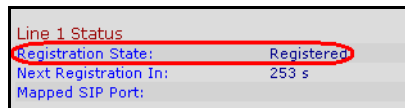

- Use an external phone to place an inbound call to the telephone number that was assigned by your ITSP. Assuming that you have left the default settings in place, the Auto Attendant answers the call. You can then dial an extension number to verify that the call rings to the station.

Configuring a Line Interface for a SPA400 (PSTN or Voice Mail)

You can configure a line interface to register the SPA9000 to a SPA400 for PSTN access or voice mail service. To enable the interoperability of the SPA9000 and the SPA400, you need to enter corresponding information on the *SPA9000 Voice > Line* page and on the *SPA400 Setup > SPA9000 Interface* page. For voice mail service, also configure the *SPA400 Setup > Voicemail Server* page.

Before you configure a line interface, be aware of the following factors:

- The SPA9000 registers to the SPA400. Therefore, the SPA400 must be connected and available when the SPA9000 attempts to register to it.
- If you have not yet set a static IP address for the SPA400, you will need to know the DHCP-obtained IP address. Review the DHCP client list on the router.



NOTE Important: For optimum Voice Mail performance, a SPA400 should be dedicated to the Voice Mail application when either of the following conditions is met:

1) More than 2 FXO connections are required

—OR—

2) More than 2 users commonly access voice mail at the same time.

- STEP 1** Start Internet Explorer, and then enter the IP address of the SPA9000. Click **Admin Login** and then click **Advanced**.
- STEP 2** Click **Voice tab > Line N**, where *N* represents the line interface number.
- STEP 3** From the *Line Enable* drop-down list, choose **yes**.
- STEP 4** Enter the following information:
- **User ID:** Enter a user ID, such as 9000.
This entry must exactly match the user ID on the *SPA400 Setup > SPA9000 Interface* page, *User ID* field. For more information, see [“Configuring a SPA400 to Interoperate with the SPA9000,”](#) on page 108.
 - **Proxy:** Enter the IP address of the SPA400.
 - **Register Expires: 60**
This setting ensures that the SPA9000 and SPA400 are resynchronized every 60 seconds. This setting ensures that any changes in settings are synchronized on both devices.

SPA9000 Voice > Line: Subscriber Information, Proxy and Registration

SIP Settings			
SIP Transport:	UDP	SIP Port:	5061
SIP 100REL Enable:	no	Auth Resync-Reboot:	yes
SIP Proxy-Require:		SIP Remote-Party-ID:	yes
SIP GUID:	no	SIP Debug Option:	none
Restrict Source IP:	no	Referor Bye Delay:	4
Refer Target Bye Delay:	0	Referee Bye Delay:	0
Refer-To Target Contact:	no	Auth INVITE:	no
Subscriber Information			
Display Name:		User ID:	9000
Password:		Use Auth ID:	no
Auth ID:		Call Capacity:	unlimited
Contact List:	aa		
Cfwd No Ans Delay:	20		
Dial Plan			
Dial Plan:	(<9:>xx.)		
NAT Settings			
NAT Mapping Enable:	no	NAT Keep Alive Enable:	no
NAT Keep Alive Msg:	\$NOTIFY	NAT Keep Alive Dest:	\$PROXY
EXT SIP Port:			
Proxy and Registration			
Proxy:	192.168.40.110		
Outbound Proxy:			
Use Outbound Proxy:	no	Use OB Proxy In Dialog:	yes
Register:	yes	Make Call Without Reg:	no
Register Expires:	60	Ans Call Without Reg:	no
Use DNS SRV:	no	DNS SRV Auto Prefix:	no

- STEP 5** Also in the *Proxy and Registration* section, enter the following settings to ensure that calls can be transferred and forwarded to the voice mail server:
- Set *VMSP Bridge* to **all** (required if this line is being used for SPA400 voice mail service).
 - Set *XFER Bridge Mode* to **all**.
 - Set *CFWD Bridge Mode* to **all**.
 - **SIP Port:** You can keep the default value. Each line must have a unique SIP port (5060 for Line 1, 5061 for Line 2, 5062 for Line 3, 5064 for Line 4).
 - **Contact List:** The default value is `aa`, for the Auto Attendant. As a general practice, you should leave the default value until after you confirm that the line is registered in the *Voice > Info* page, *Line Status* section, *Registration State* field. Then you can configure the contact list. For more information, see [“Managing Inbound Calls with the Contact List,” on page 85.](#)
- STEP 6** Proceed as needed:
- If you are using this SPA400 for voice mail service, continue to [Step 7](#).
 - If you are using this SPA400 for PSTN access only, click **Submit All Changes** to finish this procedure. You will need to configure the SPA400. For more information, see [“Configuring a SPA400 to Interoperate with the SPA9000,” on page 108](#) and [“Configuring a SPA400 for PSTN Access,” on page 111.](#)
- STEP 7** Enter the following settings for the SPA400 voice mail service:
- **Mailbox Deposit URL:** `900@<IP address of SPA400>:5090`
The SPA9000 uses this address to deposit voice mail on the voice mail server.
 - **Mailbox Manage URL:** `800@<IP address of SPA400>:5090`
The SPA9000 uses this address to access voice mail on the voice mail server.
 - **Mailbox Subscribe URL:** `8888@<IP address of SPA400>:5090`
The SPA9000 uses this address to subscribe to voice mail service on the voice mail server.
 - **Mailbox Subscribe Expires:** 30
This setting ensures that the SPA9000 and the SPA400 voice mail server are resynchronized every 30 seconds, and prevents problems when you make changes in the settings.

SPA9000 Voice > Line

Proxy and Registration			
Proxy:	192.168.0.110		
Outbound Proxy:			
Use Outbound Proxy:	no	Use OB Proxy In Dialog:	yes
Register:	yes	Make Call Without Reg:	no
Register Expires:	30	Ans Call Without Reg:	no
Use DNS SRV:	no	DNS SRV Auto Prefix:	no
Proxy Fallback Intvl:	3600	Proxy Redundancy Method:	Normal
Mailbox Status:		Mailbox Subscribe URL:	8888@192.168.0.110
Mailbox Deposit URL:	900@192.168.0.110:50	Mailbox Subscribe Expires:	30
Mailbox Manage URL:	800@192.168.0.110:50	VMSP Bridge:	None
CFWD Bridge Mode:	none	XFER Bridge Mode:	none

STEP 8 Click **Submit All Changes**. The SPA9000 device reboots.



NOTE You need to configure the SPA400 with the corresponding settings. See “Configuring Local Voice Mail Service on a SPA400,” on page 113.

Configuring Call Capacity for a Line Interface

Each line interface has a limited number of simultaneous calls that are allowed, based on the Call Capacity parameter. When the maximum call capacity is reached, the SPA9000 does not allocate any more calls to that line interface.

This section includes the following topics:

- “Bandwidth Requirements and Call Capacity,” on page 64
- “Setting the Call Capacity Parameter,” on page 65

Bandwidth Requirements and Call Capacity

The available connection bandwidth determines the maximum number of simultaneous calls that the system can support with the appropriate audio quality. Before installing and configuring the Cisco SPA components, use this information to determine the maximum number of simultaneous VoIP connections that the system can support. For asymmetric connections, such as ADSL, the maximum number of calls is determined by the upstream bandwidth. In general it is a good practice to use no more than 75% of the total available bandwidth for calls. This provides space for data traffic and helps ensure good voice quality.

The following table provides the approximate bandwidth budget for different codecs.

Table 1 Bandwidth Budgeting

Codec	Approximate bandwidth budget (kbps)				
	Each side of conversation	2 calls	4 calls	6 calls	8 calls
G.711	110	220	440	660	880
G.726-40	87	174	348	522	696
G.726-32	79	158	316	474	632
G.726-24	71	142	284	426	568
G.726-16	63	126	252	378	504
G.729	55	110	220	330	440

Setting the Call Capacity Parameter

You can set the maximum total number of incoming and outgoing calls on each line interface. The default value is unlimited. You can set a value from 1 to 15, or leave the setting as unlimited.



NOTE The SPA9000 does not distinguish between incoming and outgoing calls for call capacity.

- STEP 1** Start Internet Explorer, and then enter the IP address of the SPA9000. Click **Admin Login** and then click **Advanced**.
- STEP 2** Click **Voice tab > Line N**, where *N* represents the line interface number.
- STEP 3** Scroll down to the *Subscriber Information* section.

From the *Call Capacity* drop-down list, choose the maximum number of calls to allow.

SPA9000 Voice > Line: Subscriber Information

Subscriber Information	
Display Name:	<input type="text"/>
Password:	<input type="password" value="*****"/>
Auth ID:	<input type="text"/>
Contact List:	<input type="text" value="100,103"/>
Cfwd No Ans Delay:	<input type="text" value="20"/>
Dial Plan	
Dial Plan:	<input type="text" value="(<9:>xx.)"/>
NAT Settings	
NAT Mapping Enable:	<input type="text" value="no"/>
User ID:	<input type="text" value="19725551234"/>
Use Auth ID:	<input type="text" value="no"/>
Call Capacity:	<div style="border: 1px solid red; padding: 2px;"> unlimited 1 2 3 4 5 6 7 8 9 10 </div>

- STEP 4** Click **Submit All Changes**.

Configuring Dial Plans

Dial plans determine how the digits are interpreted and transmitted. They also determine whether the dialed number is accepted or rejected. You can use a dial plan to facilitate dialing or to block certain types of calls such as long distance or international.

This section includes information that you need to understand dial plans, as well as procedures for configuring your own dial plans. This section includes the following topics:

- “About Dial Plans,” on page 66
- “Editing Dial Plans,” on page 74

About Dial Plans

This section provides information to help you understand how dial plans are implemented.

Refer to the following topics:

- “Digit Sequences,” on page 66
- “Digit Sequence Examples,” on page 68
- “Acceptance and Transmission the Dialed Digits,” on page 71
- “Dial Plan Timer (Off-Hook Timer),” on page 72
- “Interdigit Long Timer (Incomplete Entry Timer),” on page 73
- “Interdigit Short Timer (Complete Entry Timer),” on page 73

Digit Sequences

A dial plan contains a series of digit sequences, separated by the | character. The entire collection of sequences is enclosed within parentheses. Each digit sequence within the dial plan consists of a series of elements, which are individually matched to the keys that the user presses.



NOTE White space is ignored, but may be used for readability.

Digit Sequence	Function
0 1 2 3 4 5 6 7 8 9 0 * #	Enter any of these characters to represent a key that the user must press on the phone keypad.
x	Enter x to represent any character on the phone keypad.
[sequence]	<p>Enter characters within square brackets to create a list of accepted key presses. The user can press any one of the keys in the list.</p> <ul style="list-style-type: none"> ■ Numeric range For example, you would enter [2-9] to allow the user to press any one digit from 2 through 9. ■ Numeric range with other characters For example, you would enter [35-8*] to allow the user to press 3, 5, 6, 7, 8, or *.
. (period)	Enter a period for element repetition. The dial plan accepts 0 or more entries of the digit. For example, 01. allows users to enter 0, 01, 011, 0111, and so on.
<dialled:substituted>	<p>Use this format to indicate that certain dialed digits are replaced by other characters when the sequence is transmitted. The dialled digits can be zero or more characters.</p> <p>EXAMPLE 1: <8:1650>xxxxxxx</p> <p>When the user presses 8 followed by a seven-digit number, the system automatically replaces the dialed 8 with 1650. If the user dials 85550112, the system transmits 16505550112.</p> <p>EXAMPLE 2: <:1>xxxxxxxxxxx</p> <p>In this example, no digits are replaced. When the user enters a 10-digit string of numbers, the number 1 is added at the beginning of the sequence. If the user dials 972550112, the system transmits 1972550112</p>

Digit Sequence	Function
,	<p>Enter a comma between digits to play an “outside line” dial tone after a user-entered sequence.</p> <p>EXAMPLE: 9, 1xxxxxxxxxxx</p> <p>An “outside line” dial tone is sounded after the user presses 9, and the tone continues until the user presses 1.</p>
!	<p>Enter an exclamation point to prohibit a dial sequence pattern.</p> <p>EXAMPLE: 1900xxxxxxxx!</p> <p>The system rejects any 11-digit sequence that begins with 1900.</p>
*xx	<p>Enter an asterisk to allow the user to enter a 2-digit star code.</p>
S0 or L0	<p>Enter S0 to reduce the short inter-digit timer to 0 seconds, or enter L0 to reduce the long inter-digit timer to 0 seconds.</p>

Digit Sequence Examples

The following examples show digit sequences that you can enter in a dial plan.

In a complete dial plan entry, sequences are separated by a pipe character (|), and the entire set of sequences is enclosed within parentheses.

EXAMPLE: ([1-8]xx | 9, xxxxxxxx | 9, <:1>[2-9]xxxxxxxxxx | 8, <:1212>xxxxxxxx | 9, 1 [2-9] xxxxxxxxxxx | 9, 1 900 xxxxxxxx ! | 9, 011xxxxxx. | 0 | [49]11)

- Extensions on your system

EXAMPLE: ([1-8]xx | 9, xxxxxxxx | 9, <:1>[2-9]xxxxxxxxxx | 8, <:1212>xxxxxxxx | 9, 1 [2-9] xxxxxxxxxxx | 9, 1 900 xxxxxxxx ! | 9, 011xxxxxx. | 0 | [49]11)

[1-8]xx Allows a user dial any three-digit number that starts with the digits 1 through 8. If your system uses four-digit extensions, you would instead enter the following string: **[1-8]xxx**

- Local dialing with seven-digit number

EXAMPLE: ([1-8]xx | 9, xxxxxxxx | 9, <:1>[2-9]xxxxxxxxxx | 8, <:1212>xxxxxxxx | 9, 1 [2-9] xxxxxxxxxxx | 9, 1 900 xxxxxxxx ! | 9, 011xxxxxxxx. | 0 | [49]111)

9, xxxxxxxx After a user presses 9, an external dial tone sounds. The user can enter any seven-digit number, as in a local call.

- Local dialing with 3-digit area code and a 7-digit local number

EXAMPLE: ([1-8]xx | 9, xxxxxxxx | 9, <:1>[2-9]xxxxxxxxxx | 8, <:1212>xxxxxxxx | 9, 1 [2-9] xxxxxxxxxxx | 9, 1 900 xxxxxxxx ! | 9, 011xxxxxxxx. | 0 | [49]11)

9, <:1>[2-9]xxxxxxxxxx This example is useful where a local area code is required. After a user presses 9, an external dial tone sounds. The user must enter a 10-digit number that begins with a digit 2 through 9. The system automatically inserts the 1 prefix before transmitting the number to the carrier.

- Local dialing with an automatically inserted 3-digit area code

EXAMPLE: ([1-8]xx | 9, xxxxxxxx | 9, <:1>[2-9]xxxxxxxxxx | 8, <:1212>xxxxxxxx | 9, 1 [2-9] xxxxxxxxxxx | 9, 1 900 xxxxxxxx ! | 9, 011xxxxxxxx. | 0 | [49]11)

8, <:1212>xxxxxxxx This example is useful where a local area code is required by the carrier but the majority of calls go to one area code. After the user presses 8, an external dial tone sounds. The user can enter any seven-digit number. The system automatically inserts the 1 prefix and the 212 area code before transmitting the number to the carrier.

- U.S. long distance dialing

EXAMPLE: ([1-8]xx | 9, xxxxxxxx | 9, <:1>[2-9]xxxxxxxxxx | 8, <:1212>xxxxxxxx | 9, 1 [2-9] xxxxxxxxxxx | 9, 1 900 xxxxxxxx ! | 9, 011xxxxxxxx. | 0 | [49]11)

9, 1 [2-9] xxxxxxxxxxx After the user presses 9, an external dial tone sounds. The user can enter any 11-digit number that starts with 1 and is followed by a digit 2 through 9.

- Blocked number

EXAMPLE: ([1-8]xx | 9, xxxxxxxx | 9, <:1>[2-9]xxxxxxxxxx | 8, <:1212>xxxxxxxx | 9, 1 [2-9] xxxxxxxxxxxx | **9, 1 900 xxxxxxxx !** | 9, 011xxxxxx. | 0 | [49]11)

9, 1 900 xxxxxxxx ! This digit sequence is useful if you want to prevent users from dialing numbers that are associated with high tolls or inappropriate content, such as 1-900 numbers in the U.S.. After the user press 9, an external dial tone sounds. If the user enters an 11-digit number that starts with the digits 1900, the call is rejected.

- U.S. international dialing

EXAMPLE: ([1-8]xx | 9, xxxxxxxx | 9, <:1>[2-9]xxxxxxxxxx | 8, <:1212>xxxxxxxx | 9, 1 [2-9] xxxxxxxxxxxx | 9, 1 900 xxxxxxxx ! | **9, 011xxxxxx.** | 0 | [49]11)

9, 011xxxxxx. After the user presses 9, an external dial tone sounds. The user can enter any number that starts with 011, as in an international call from the U.S.

- Informational numbers

EXAMPLE: ([1-8]xx | 9, xxxxxxxx | 9, <:1>[2-9]xxxxxxxxxx | 8, <:1212>xxxxxxxx | 9, 1 [2-9] xxxxxxxxxxxx | 9, 1 900 xxxxxxxx ! | 9, 011xxxxxx. | **0 | [49]11**)

0 | [49]11 This example includes two digit sequences, separated by the pipe character. The first sequence allows a user to dial 0 for an operator. The second sequence allows the user to enter 411 for local information or 911 for emergency services.

Acceptance and Transmission the Dialed Digits

When a user dials a series of digits, each sequence in the dial plan is tested as a possible match. The matching sequences form a set of candidate digit sequences. As more digits are entered by the user, the set of candidates diminishes until only one or none are valid. When a terminating event occurs, the SPA9000 either accepts the user-dialed sequence and initiates a call, or else rejects the sequence as invalid. The user hears the reorder (fast busy) tone if the dialed sequence is invalid.

The following table explains how terminating events are processed.

Terminating Event	Processing
The dialed digits do not match any sequence in the dial plan.	The number is rejected.
The dialed digits exactly match one sequence in the dial plan.	<ul style="list-style-type: none"> ▪ If the sequence is allowed by the dial plan, the number is accepted and is transmitted according to the dial plan. ▪ If the sequence is blocked by the dial plan, the number is rejected.
A timeout occurs.	<p>The number is rejected if the dialed digits are not matched to a digit sequence in the dial plan within the time specified by the applicable interdigit timer.</p> <ul style="list-style-type: none"> ▪ The Interdigit Long Timer applies when the dialed digits do not match any digit sequence in the dial plan. The default value is 10 seconds. ▪ The Interdigit Short Timer applies when the dialed digits match one or more candidate sequences in the dial plan. The default value is 3 seconds.
The user presses the # key or the dial softkey on the phone display.	<ul style="list-style-type: none"> ▪ If the sequence is complete and is allowed by the dial plan, the number is accepted and is transmitted according to the dial plan. ▪ If the sequence is incomplete or is blocked by the dial plan, the number is rejected.

Dial Plan Timer (Off-Hook Timer)

You can think of the Dial Plan Timer as “the off-hook timer.” This timer starts counting when the phone goes off hook. If no digits are dialed within the specified number of seconds, the timer expires and the null entry is evaluated. Unless you have a special dial plan string to allow a null entry, the call is rejected. The default value is 5.

Syntax for the Dial Plan Timer

SYNTAX: (*P*s<:n> | *dial plan*)

- **s:** The number of seconds; if no number is entered after *P*, the default timer of 5 seconds applies.
- **n:** (optional): The number to transmit automatically when the timer expires; you can enter an extension number or a DID number. No wildcard characters are allowed because the number will be transmitted as shown. If you omit the number substitution, <n>, then the user hears a reorder (fast busy) tone after the specified number of seconds.

Examples for the Dial Plan Timer

- Allow more time for users to start dialing after taking a phone off hook.

EXAMPLE: (**P9** | (9,8<:1408>[2-9]xxxxxxx | 9,8,1[2-9]xxxxxxxxxx | 9,8,011xx. | 9,8,xx. |[1-8]xx)

P9 After taking a phone off hook, a user has 9 seconds to begin dialing. If no digits are pressed within 9 seconds, the user hears a reorder (fast busy) tone. By setting a longer timer, you allow more time for users to enter the digits.

- Create a hotline for all sequences on the System Dial Plan

EXAMPLE: (**P9<:23>** | (9,8<:1408>[2-9]xxxxxxx | 9,8,1[2-9]xxxxxxxxxx | 9,8,011xx. | 9,8,xx. |[1-8]xx)

P9<:23> After taking the phone off hook, a user has 9 seconds to begin dialing. If no digits are pressed within 9 seconds, the call is transmitted automatically to extension 23.

- Create a hotline on a line button for an extension

EXAMPLE: (**P0 <:1000>**)

With the timer set to 0 seconds, the call is transmitted automatically to the specified extension when the phone goes off hook. Enter this sequence in the Phone Dial Plan for Ext 2 or higher on a client station.

Interdigit Long Timer (Incomplete Entry Timer)

You can think of this timer as the “incomplete entry” timer. This timer measures the interval between dialed digits. It applies as long as the dialed digits do not match any digit sequences in the dial plan. Unless the user enters another digit within the specified number of seconds, the entry is evaluated as incomplete, and the call is rejected. The default value is 10 seconds.



NOTE This section explains how to edit a timer as part of a dial plan. Alternatively, you can modify the Control Timer that controls the default interdigit timers for all calls. See “Resetting the Control Timers,” on page 77.

Syntax for the Interdigit Long Timer

SYNTAX: `L:s, (dial plan)`

- **s:** The number of seconds; if no number is entered after `L:`, the default timer of 5 seconds applies.
- Note that the timer sequence appears to the left of the initial parenthesis for the dial plan.

Example for the Interdigit Long Timer

EXAMPLE: L:15, `(9,8<:1408>[2-9]xxxxxx | 9,8,1[2-9]xxxxxxxxxx | 9,8,011xx. | 9,8,xx. |[1-8]xx)`

L:15, This dial plan allows the user to pause for up to 15 seconds between digits before the Interdigit Long Timer expires. This setting is especially helpful to users such as sales people, who are reading the numbers from business cards and other printed materials while dialing.

Interdigit Short Timer (Complete Entry Timer)

You can think of this timer as the “complete entry” timer. This timer measures the interval between dialed digits. It applies when the dialed digits match at least one digit sequence in the dial plan. Unless the user enters another digit within the specified number of seconds, the entry is evaluated. If it is valid, the call proceeds. If it is invalid, the call is rejected. The default value is 3 seconds.

Syntax for the Interdigit Short Timer

- **SYNTAX 1:** *S:s, (dial plan)*

Use this syntax to apply the new setting to the entire dial plan within the parentheses.

- **SYNTAX 2:** *sequence Ss*

Use this syntax to apply the new setting to a particular dialing sequence.

s: The number of seconds; if no number is entered after *S*, the default timer of 5 seconds applies.

Examples for the Interdigit Short Timer

- Set the timer for the entire dial plan.

EXAMPLE: **S:6**, (9,8<:1408>[2-9]xxxxxx | 9,8,1[2-9]xxxxxxxxxx | 9,8,011xx. | 9,8,xx. |[1-8]xx)

S:6, While entering a number with the phone off hook, a user can pause for up to 15 seconds between digits before the Interdigit Short Timer expires. This setting is especially helpful to users such as sales people, who are reading the numbers from business cards and other printed materials while dialing.

- Set an instant timer for a particular sequence within the dial plan.

EXAMPLE: (9,8<:1408>[2-9]xxxxxx | **9,8,1[2-9]xxxxxxxxS0** | 9,8,011xx. | 9,8,xx. |[1-8]xx)

9,8,1[2-9]xxxxxxxxS0 With the timer set to 0, the call is transmitted automatically when the user dials the final digit in the sequence.

Editing Dial Plans

You can edit dial plans and can modify the control timers.

Editing the System Dial Plan

Follow this procedure to edit the system dial plan, which will be auto-provisioned to the first extension of each phone.

STEP 1 Connect to the SPA9000 administration web server, and choose Admin access with Advanced settings.

STEP 2 Click **Voice tab > SIP**.

STEP 3 Scroll down to the *PBX Phone Parameters* section.

SPA9000 Voice tab > SIP page: PBX Phone Parameters section

PBX Phone Parameters	
Next Auto User ID:	106
Phone Upgrade Rule:	
Phone Dial Plan:	(9,[3469]11S0 9,<:1408>[2-9]xxxxxx 9,<:1>[2-9]xxxxxxxxxS0 9,1[2-9]x
Phone Config XML:	
Use LVS_PROXY:	no
CTI Enable:	yes

STEP 4 Enter the digit sequences in the *Dial Plan* field. For more information and examples, see “[Digit Sequences](#),” on page 66.



NOTE Separate each digit sequence with a pipe character, and enclose the entire set of digit sequences within parentheses. Refer to the following example:

```
( 9, 8<:1408>[ 2-9 ]xxxxxxx | 9, 8, 1[ 2-9 ]xxxxxxxxxxx |
9, 8, 011xx. | 9, 8, xx. | [1-8]xx )
```

STEP 5 Click **Submit All Changes**. The phones reboot.

STEP 6 Verify that you can successfully complete a call using each digit sequence that you entered in the dial plan.



NOTE If you hear a reorder (fast busy) tone, you need to review your entries and modify the dial plan appropriately. See “[Digit Sequences](#),” on page 66.

Entering a Phone Dial Plan

The phone dial plan is automatically updated when the system phone dial plan is modified. There are special cases where it is required to enter the phone dial plan directly on the phone. Follow the procedure below to enter a dial plan for a particular extension on a client station in the following cases:

- The phone is outside the SPA9000 multicast domain (e.g. when the phone is connected to the SPA9000 via a VPN connection).
- For additional extensions on an existing phone (the system wide phone dial plan is propagated only to extension 1 of all phones).

-
- STEP 1** Start Internet Explorer, and then enter the IP address of the SPA9000. Click **Admin Login** and then click **Advanced**.
- STEP 2** Click the **PBX Status** link near the top right corner or lower left corner of the page, to view the list of client stations.
- STEP 3** Click the hyperlink in the *IP Address* column for the first phone that you want to configure. The telephone configuration page appears in a separate browser window.
- STEP 4** Click the **Ext 1** tab, or the tab for the extension that you want to configure.
- STEP 5** Scroll down to the *Dial Plan* section.
- STEP 6** Enter the digit sequences in the *Dial Plan* field.
- The default (US-based) system-wide dial plan appears automatically in the field. You can delete digit sequences, add digit sequences, or replace the entire dial plan with a new dial plan. For more information and examples, see [“Digit Sequences,” on page 66](#).
 - Separate each digit sequence with a pipe character, and enclose the entire set of digit sequences within parentheses. Refer to the following example:
(9,8<:1408>[2-9]xxxxxx | 9,8,1[2-9]xxxxxxxxxx | 9,8,011xx.
| 9,8,xx. |[1-8]xx)
- STEP 7** Click **Submit All Changes**. The phone reboots.
- STEP 8** If you need to configure a dial plan for any other extensions on the phone (depending on the model), click the appropriate *Extension* tab, enter the dial plan, and submit the changes.
- STEP 9** Click the browser’s **Back** button to return to the list of phones.
- STEP 10** Repeat this procedure for each client station that needs a unique dial plan.
- STEP 11** Verify that you can successfully complete a call using each digit sequence that you entered in the dial plan.



NOTE If you hear a reorder (fast busy) tone, you need to review your entries and modify the dial plan appropriately. See [“Digit Sequences,” on page 66](#).

Entering the Line Interface Dial Plan

This dial plan is used to strip steering digits from a dialed number before it is transmitted out to the carrier.

-
- STEP 1** Connect to the administration web server, and choose Admin access with Advanced settings.
 - STEP 2** Click **Voice tab > Line *N***, where *N* represents the line interface number.
 - STEP 3** Scroll down to the *Dial Plan* section.
 - STEP 4** Enter the digit sequences in the *Dial Plan* field. For more information, see [“About Dial Plans,” on page 66](#).
 - STEP 5** Click **Submit All Changes**.
-

Resetting the Control Timers

You can use the following procedure to reset the default timer settings for all calls.



NOTE If you need to edit a timer setting only for a particular digit sequence or type of call, you can edit the dial plan. See [“About Dial Plans,” on page 66](#).

-
- STEP 1** Connect to the administration web server, and choose Admin access with Advanced settings.
 - STEP 2** Click **Voice tab > Regional**.
 - STEP 3** Scroll down to the *Control Timer Values* section.
 - STEP 4** Enter the desired values in the *Interdigit Long Timer* field and the *Interdigit Short Timer* field. Refer to the definitions at the beginning of this section.
-

Managing the Line Selection for Outbound Calls

When a user places an outbound call, the SPA9000 chooses a line based on the group membership of the station and the Call Routing Rule for the line interface. You can configure the settings to route calls through particular lines, based on factors such as the dialed number, the destination, or the corporate identity that you want to represent.

This feature can be used whether the SPA9000 line interface is configured for an ITSP or a SPA400 voice gateway.

This section includes the following topics:

- “Line Availability,” on page 78
- “Configuring a Call Routing Rule,” on page 79
- “Entering a Call Routing Rule,” on page 81

Line Availability

The SPA9000 considers a line to be available for an outgoing call if the following conditions are met:

- The line is enabled in the configuration and is functioning. See “Configuring Line Interfaces on the SPA9000,” on page 58.
- The line is authorized by the *Call Routing Rule* for the dialed number. See “Configuring a Call Routing Rule,” on page 79.
- The line has capacity to take more calls. See “Configuring Call Capacity for a Line Interface,” on page 63.
- The Dial Plan for this line allows the dialed number. See “Configuring Dial Plans,” on page 66.

Configuring a Call Routing Rule

A Call Routing Rule is a special dial plan that specifies the lines that can be used to transmit a dialed number. The same number pattern can apply to more than one line.

SYNTAX: (<:Lw,x,y,z>number-pattern | <:Lw,x,y,z>number-pattern | <:Lw,x,y,z>number-pattern | <:Lw,x,y,z>number-pattern)

- **L:** A signifier for “Line”
- **w, x, y, z:** The number of the line interface (L1 for Line 1, L2 for Line 2, and so on)
- **port:** The port number



NOTE This parameter applies only if the line interface is configured for a SPA400.

- **number-pattern:** The dialed sequence that can use the specified lines
- **Other elements:**
 - Enclose the entire call routing rule in parentheses.
 - Use a comma to separate each digit sequence within a number-pattern.
 - Use a pipe character (|) to separate each call routing rule.



NOTE The Call Routing rules use the same digit sequences as the Dial Plan rules. See “Digit Sequences,” on page 66.

- Allowing any line interface to be used

EXAMPLE: (<:L1,2,3,4>9xx.)

Any line interface can be used for any dialed sequence that begins with 9 and includes at least two additional numbers. The SPA9000 chooses an available line from the list, proceeding in the listed order. See “Line Availability,” on page 78.

- Different line interfaces for U.S., international, and 1-800 numbers

EXAMPLE: (<:L1,2>9xx. | <:L3>011852xx. | <:L4>1800xxxxxxxx)

This example has three parts:

- <:L1,2>9xx. Line 1 and Line 2 can be used if the sequence starts with 9 and includes at least two additional digits.
 - <:L3>011852xx. Line 3 can be used if the sequence starts with 011852 and includes at least two additional digits.
 - <:L4>1800xxxxxxxx. Line 4 can be used if the sequence starts with 1800 and includes at least seven additional digits.
- Separate lines for long distance and local calling

EXAMPLE: (<:L1>9xx. | <:L2>8xx.)

Line 1 is used for any dialed sequence that starts with 9. Line 2 is used for any dialed sequence that starts with 8. This call routing rule is effective if users understand that 9 is the steering digit for long distance (with Line 1 configured for the ITSP and its inexpensive long distance service) and that 8 is the steering digit for local calls (with Line 2 configured for a SPA400 that has local phone lines connected).

- Specifying a hunt order for FXO lines on one SPA400 unit

EXAMPLE: (<:L2{1,2}>8xx)

Line 2 is configured for a SPA400. This line is used for any dialed sequence that starts with 8. The preference is to seize port 1. If port 1 is unavailable, the next preference is to seize line 2. If neither port is available, then the call fails.

- Specifying a hunt order for FXO lines on multiple SPA400 units

EXAMPLE: (<:L4{1},3,2{2,4}>9xx)

Lines 2, 3, and 4 are configured for SPA400 units. These lines are used for any dialed sequence that starts with 9. The preference is to use Line 4, port 1. If it is unavailable, then any port on Line 3 can be used. If Line 3 is unavailable, then the next choice is Line 2, port 2. If it is unavailable, the next choice is Line 2, port 4. If it is unavailable, then the call fails.

- Wildcard characters

EXAMPLE: (<:L1>51*,577?)

In this example, Line 1 can be used when either of the following number patterns is dialed:

- The user dials a number that starts with 51, followed by any other characters.
- The user dials any four-digit number starting with 577.

Entering a Call Routing Rule

Use the following procedure to enter a call routing rule.

-
- STEP 1** Start Internet Explorer, and then enter the IP address of the SPA9000. Click **Admin Login** and then click **Advanced**.
 - STEP 2** Click **Voice tab > SIP**.
 - STEP 3** Scroll down to the *PBX Parameters* section.
 - STEP 4** In the *Call Routing Rule* field, enter the rule that you want to apply
 - STEP 5** Click **Submit All Changes**.
 - STEP 6** To verify your progress, place a call to a phone that has caller ID, and confirm that the expected number appears.
-

Managing Caller ID Settings for Outgoing Calls

By default, outgoing calls through an ITSP line are identified by the User ID (usually the phone number) and Display Name of the selected line interface. Alternatively, you can map a DID number to a phone extension so that all outbound calls from that extension will identify the caller by the DID number and the assigned phone display name. (See “[Supporting Multiple DID Numbers Per Line Interface](#),” on [page 87](#).)



NOTE Caller ID for a PSTN line is controlled by the phone company. Caller ID through an ITSP line should work as described, but if not, contact your ITSP to see what is allowed for caller ID configuration.

-
- STEP 1** Start Internet Explorer, and then enter the IP address of the SPA9000. Click **Admin Login** and then click **Advanced**.
- STEP 2** Click **Voice > Line *N***, where *N* represents the line interface number.
- STEP 3** Scroll down to the *Subscriber Information* section.
- STEP 4** Enter the desired display name for Caller ID in the *Display Name* field.
- STEP 5** Click **Submit All Changes**.
-

Call Forwarding Support on SPA9000

SPA9000 supports the following Call Forward settings on the client station:

- CFWD All: Forwards all calls unconditionally
- CFWD Busy: Forwards calls received when the station is busy
- CFWD NoAns: Forwards calls when there is no answer

SPA9000 supports the call forward scenarios listed in the following table.

Called Party	Caller	Forward Target	Remarks
Client station	Client station	Client station	Proxy only; no direct involvement
Client station	Client station	External	Very similar to calling external number
Client station	External	Client station	ACKs the 302 from called party. Then INVITEs the target. NOTE If the original INVITE is forked to more than one client station, call forward is not performed.
Client station	External	External	ACKs the 302 from called party. Sends 200 to caller, then blind REFERS caller to target. NOTE If the original INVITE is forked to more than one client station, call forward is not performed
External	Client station	External	ACKs the 302 from called party, then INVITEs the target



NOTE When an incoming call from the ITSP is forked to multiple client stations, the SPA9000 does not honor the 3xx response returned by any of the client stations. If you wish the call to be forwarded to voicemail or another client station when it is not picked up, you can specify the optional “*cfwd=target*” syntax in the Contact List.

Call Transfer Support on SPA9000

You can configure the bridge mode for call forward and call transfer.

Call Forward Bridge Mode

The normal way of performing the call forwarding operation is for the SPA9000 to send a (blind) SIP REFER to the calling device to let it contact the target number directly. It then drops out of the call completely. This requires the calling device to understand the SIP signaling involved and the operation permitted by the underlying service provider. The SPA400 cannot handle this operation.

With bridging, the SPA9000 maintains two separate call legs throughout the call: one with the caller and one with the call forward target. The two call peers connect only with the SPA9000, while the SPA9000 acts as a proxy for the RTP packets exchanged between the two parties. On the *Voice > Line N* page, *Proxy and Registration* section, the *CWFD Bridge Mode* field has two possible values:

- none—Do not bridge forwarded calls (use the normal REFER method)
- all—Bridge all forwarded calls

Call Transfer Bridge Mode

The normal way of performing this operation is for the SPA9000 to send a SIP REFER method to the calling device to let it contact the transfer target directly. The SPA9000 then drops out of the call completely. This requires the calling device (the transferee) and the target device to understand the SIP signaling involved and the operation permitted by the underlying service providers. Note that the call legs with transferee and the transfer target might be with different ITSP. The SPA400, for instance, cannot handle this operation.

With bridging, the SPA9000 maintains two separate call legs throughout the call: one with the transferred call and one with the transfer target. The two call peers connect only with the SPA9000, while the SPA9000 acts as a proxy for the RTP packets exchanged between the two parties. On the *Voice > Line N* page, *Proxy and Registration* section, the *XFER Bridge Mode* field has three possible values:

- none: Do not bridge call transfer (use the normal REFER method)
- all: Bridge all call transfer
- all except same line: Bridge call transfer only between different line interfaces

Managing Inbound Calls with the Contact List

You can use the Contact List to route inbound calls to the Auto Attendant, to a receptionist, to a client station, to a group of stations, or to a combination of these.

- “Routing an Inbound Call to the Auto Attendant,” on page 85
- “Routing an Inbound Call to a Receptionist or Client Stations,” on page 85
- “Example Contact List Rules,” on page 86
- “Entering a Contact List Rule,” on page 91

Routing an Inbound Call to the Auto Attendant

By default, all inbound calls are routed to the Auto Attendant (**aa**). This automated system answers inbound calls by playing pre-recorded voice message that asks the caller to enter the desired extension. If you want only the Auto Attendant to receive a call, keep the default setting, **aa**, in the *Contact List* field on the *Voice > Line N* page, *Subscriber Information* section, for each line interface. For more information, see [Chapter 7, “Configuring the Auto Attendant.”](#)

Routing an Inbound Call to a Receptionist or Client Stations

You can route an inbound call to a receptionist or to client stations by using a Contact List. You specify the Contact List for each line interface (Line 1, Line 2, Line 3, Line 4). For example, if Line 1 is configured for an ITSP account, and a call is placed to a Direct Inward Dialing (DID) number for that account, then the call is routed to the Contact List that is specified on the Line 1 configuration page. Likewise, if Line 2 is configured for a SPA400 that has PSTN lines attached, and a call is placed to the associated PSTN phone number, then the call is routed as specified in the *Voice > Line* page, *Subscriber Information* section, *Contact List* field.

Example Contact List Rules

The following examples show rules that you can enter to route incoming calls.



NOTE The SPA9000 alerts all registered clients stations if * is used in the Contact List (*SPA9000 Voice > Line N page > Subscriber Information* section).

- Routing calls to a receptionist

EXAMPLE: 100

An incoming call to any DID number on this line interface causes station 100 to ring. The receptionist answers the call. If the call is not answered, it automatically goes to the voice mailbox for station 100, assuming that voice mail is configured.

- Routing calls simultaneously to two or more stations

EXAMPLE: 100, 104

An incoming call to any DID number on this line interface causes station 100 and station 104 to ring. Either station can answer the call.



NOTE The list of extension numbers may include * to represent multiple wildcard characters or ? to represent a single wildcard character. For example, 10? represents all stations numbered 100 through 109.

- Special routing for different DID numbers

EXAMPLE: 9725550155:100|9725550156:101, 102

An incoming call to 972-555-0155 causes station 100 to ring. An incoming call to 972-555-0156 causes station 101 and station 102 to ring simultaneously.



NOTE In this example, the rules are separated by a pipe character (|) to indicate an “or” condition.

- Routing calls to a station and forwarding unanswered calls to voice mail

EXAMPLE 1: 5300, cfwd=vm25300

An incoming call through this line interface causes station 5300 to ring. If there is no answer, the call is forwarded to the voice mail server on line interface 2, mailbox number 5300. The time interval is determined by the value *Cfwd No Ans Delay* field, which is located below the *Contact List* field on the *Voice > Line* page. The default value is 20 seconds.

EXAMPLE 2: 4085550122:5001 | 4085550123:5000, cfwd=aa

An incoming call to 408-555-0122 causes station 5001 to ring. An incoming call to 408-555-0123 causes station 5000 to ring. If station 5000 does not answer its call, the call is forwarded to the Auto Attendant. The time interval is determined by the value *Cfwd No Ans Delay* field, which is located below the *Contact List* field. The default value is 20 seconds.

- Routing a call with a hunt rule

EXAMPLE: 530?, hunt=ra;10;2, cfwd=vm25404

An incoming call through this line interface causes one station in the group 5300 through 5309 to ring. The station is chosen randomly (*ra*). After 10 seconds, if the call is unanswered, then another station is chosen randomly from the remaining stations. The system cycles through the list two times. If the call is unanswered, it is forwarded to the voice mail server on line interface 2, mailbox 5404.



NOTE A hunt rule in the contact list applies only to calls on the selected line interface. You also can create hunt groups that apply to all lines. For more information and additional examples of syntax that can be used in a hunt rule in the Contact List, see [“Managing Inbound Calls with Hunt Groups,” on page 92.](#)

Supporting Multiple DID Numbers Per Line Interface

An ITSP can provide a block of DID numbers, for example with a main number of 4085553000, and additional DID numbers from 4085553001–4084443009. The ITSP can identify the local client stations to which an external incoming call should be routed. Linksys recommends including this information in the TO header of the incoming INVITE while the request-URI is addressed to the line interface user-id. In the INVITE, the ITSP indicates the DID number in the TO header user-id field.

EXAMPLE SIP Header 1:

```
INVITE sip:4089993000@itspl.com SIP/2.0
To: <sip:4089993003@itspl.com>
```

Alternatively, the DID number can be indicated as a parameter in the TO header with a configurable parameter name, such as `didn`.

EXAMPLE SIP Header 2:

```
INVITE sip:4089993000@itspl.com SIP/2.0
To: <sip:4089993000@itspl.com>;didn=4089993003
```

You can identify the field to use for the DID number and the parameter name on the *Voice > SIP* page, *PBX Parameters* section, *SIP DIDN* and *SIP DIDN Param Name* fields. For the first example above, these two fields are ignored; for the second example, *SIP DIDN* is set to **TO Param** and *SIP DIDN Param Name* is set to **didn**.

The Contact List is used to route the calls to a client station based on DID numbers that are embedded in the INVITE message.

EXAMPLE Contact List Rule:

```
4089993000:aa | 4089993001:3001 | 4089993002:3002 |... | 4089993009:3009
```

An incoming call to the main number is answered by the Auto-Attendant, while calls to the other nine DID numbers are routed to dedicated private extensions.

Supporting Direct Inward Dialing to Phone Extensions

Direct Inward Dialing allows the external users to dial directly any phone extension in the SPA9000 Voice System, without passing through the Auto Attendant or the receptionist.

Before proceeding with the configuration you need to have the full correspondence between the external (DID) number and the extension number. [Table 1, “DID-to-Extension Mapping Example,” on page 89](#) provides an example.

Table 1 DID-to-Extension Mapping Example

DID number	Extension number	User
408-555-5550	aa	Auto Attendant
408-555-5551	101	User 1
408-555-5552	102	User 2
408-555-5553	103	User 3
408-555-5554	104	User 4
408-555-5650	500	Support (hunt) group

Be aware of the following factors:

- Direct Inward Dialing requires network support for SIP trunking DID.
- It is important that the DID number format match exactly the format of the number signaled in the SIP trunk.
- Please check with your Service Provider to confirm the availability of this feature and the correct DID number format, before proceeding with this configuration.

SYNTAX:

```
<DIDn1>:+<Extn1> | <DIDn2>:+<Extn2> | <DIDn3>:+<Extn3> | <DIDn4>:+
<Extn4> | <DIDn5>:+
<Extn5> | <DIDn6>:+<Extn6> | <DIDn7>:+<Extn7> | <DIDn8>:+<Extn8> |
<DIDn9>:+<Extn9> |
<DIDn10>:+<Extn10> | <DIDn11>:+<Extn11> | <DIDn12>:+<Extn12> | <DI
Dn13>:+<Extn13> |
<DIDn14>:+<Extn14> | <DIDn15>:+<Extn15> | <DIDn16>:+<Extn16> | <de
fault_route>
```

EXAMPLE:

```
4085555550:aa | 4085555551:+101 | 4085555552:+102 | 4085555553:+103 | 4085555554:+104 | 4085555650:+500 |
```

- Enter a plus (+) or a minus (-) before the extension number to achieve the desired results for caller ID and call routing:
 - + <Extn1> The extension will be alerted when there is an incoming call to the DID number, and the DID number will be used as the local user-ID in outbound SIP requests, along with the display-name of the extension.
 - - <Extn1> The extension will not be alerted when there is an incoming call to the DID number. However, the DID number will be used as the local user-ID in outbound SIP requests, along with the display-name of the extension.
DIDn#: DID number, matching the format of the number signaled in the SIP trunk
- Extn#: Target extension number or a for Auto Attendant
- Default route: The default route (extension, hunt group or Auto Attendant) to be used in case the incoming target number does not match any of the DID numbers in the contact list with the format described in the sections above.
- Call forwarding: Optionally, add call forward information to the Contact List to specify how unanswered calls are handled.

It is useful to add call forward information to ensure that calls are answered when the designated phone is unstaffed, as may be the case during lunch time or after hours. In this case, if the call is not answered within a specified time, the call is routed to another phone or to the Auto Attendant.

SYNTAX:

```
<DIDn1>:+<Extn1>,cfwd=<target> | <DIDn2>:+<Extn2>,cfwd=<target> | <DIDn3>:+<Extn3>,cfwd=<target>
```

EXAMPLE:

```
4085555550:aa | 4085555551:+101,cfwd=aa | 4085555552:+102 | 4085555553:+103 | 4085555554:+104 | 4085555650:+500 |
```

Entering a Contact List Rule

Use the following procedure to enter a contact list rule.

- STEP 1** Connect to the SPA9000 administration web server, and choose Admin access with Advanced settings.
- STEP 2** Click **Voice tab > Line N**, where *N* represents the line interface number.
- STEP 3** Scroll down to the *Subscriber Information* section.

SPA9000 Voice > Line: Subscriber Information

Subscriber Information			
Display Name:	14088501231	User ID:	14088501231
Password:		Use Auth ID:	no
Auth ID:		Call Capacity:	
Contact List:	aa		
Cfwd No Ans Delay:	20		

- STEP 4** Enter the desired rules in the *Contact List* field. For more information, see “[Example Contact List Rules](#),” on page 86 and “[Entering a Contact List Rule](#),” on page 91.



NOTE The maximum length of the <Contact List> parameter is 383 characters.

- STEP 5** If you included a call forward rule, modify the *Cfwd No Ans Delay* parameter to specify the number of seconds that elapse before a call is considered to be unanswered.
- STEP 6** Click **Submit All Changes**. The SPA9000 reboots.
- STEP 7** To verify your progress, make an inbound call and verify that the call is handled as you intended.

Managing Inbound Calls with Hunt Groups

A Hunt Group is a group of client stations that are treated as one extension for the purpose of managing inbound calls. The client stations in the hunt group can be alerted simultaneously or sequentially. The first client station to pick up the call establishes a private connection to the caller.



NOTE Compare a Shared Line Appearance to a Hunt Group. A Hunt Group may ring several stations simultaneously, but only one station can answer and manage the call. A Shared Line Appearance also rings multiple lines simultaneously but allows multiple stations to share and manage the call. For more information, see [“Managing Inbound Calls with Shared Line Appearances,”](#) on page 98.

There are two types of hunt rules:

- **Global Hunt Rule:** The hunt rule applies to all line interfaces. Enter this type of hunt rule on the Voice tab > SIP page > PBX Parameter section, Hunt Groups field.
- **Line-Specific (Contact List) Hunt Rule:** The hunt rule applies to a particular line interface. Enter this type of hunt rule on the Voice tab > Line *N* page > Subscriber Information section > Contact List field. For example, if you enter this rule on the Line 1 page, it applies only to the calls that are received on Line 1.

The syntax for the two types of rules varies, as described later in this section. If you define a hunt group both in the Contact List and on the SIP page > PBX Parameters section, the call forward parameter from the Contact List is ignored; instead, the call forward parameter defined on the SIP page > PBX Parameter section is used.

Syntax for Hunt Rules

- **Global Hunt Rule**

(SIP page > PBX Parameters section > Hunt Groups field)

SYNTAX: `extension:[name="name",]station[,station[,station[...]]],hunt=hrule[,cfwd=target]`

- **Line-Specific Hunt Rule**

(Line *N* page > Subscriber Information section > Contact List field)

SYNTAX: `station[,station[,station[...]]],hunt=hrule;[,cfwd=target]`

Parameters

- `extension`: An extension number for the hunt group
- `name`: A name for the hunt group, which will appear in the Corporate Directory
- `station`: The extension numbers; the wildcard symbols ? and * can be used to represent one or more characters
- `hunt=hrule`: The hunt order, ring interval, and maximum duration, in the following format: `hunt=algo;interval;max`
 - `algo`: The hunt order.
 - `re`: Restart. Hunting starts at the beginning of the list. If the first station does not answer within the specified `interval` (see below), the hunt proceeds through the stations in sequential order.
 - `ne`: Next. The system determines the station that was chosen in the previous hunt, and hunting starts with the next station in the list. If that station does not answer within the specified `interval` (see below), the hunt proceeds through the stations in sequential order.
 - `ra`: Random order. The system randomly chooses a station from the list. If the selected station does not answer within the specified `interval` (see below), the hunt proceeds randomly through the unchosen stations until each station is tried.
 - `al`: All. The system rings all the stations at the same time.
 - `interval`: The number of seconds to wait for one station to answer, before choosing another station. If `interval` is *, the hunt is stopped at the first station that starts ringing, and rings the station until it answers, or the caller hangs up, or the station's ringer times out.

- `max`: The maximum duration of the hunt, either in seconds or cycles. When this limit is reached, the call is rejected or is forwarded to the specified call forward number (see below).
 - If `max` is greater than `interval`, it represents the total time in seconds to hunt.
 - If `max` is less than `interval`, it represents the maximum number of times to cycle through the hunt group. If `max` is 0, hunting continues indefinitely until the caller either hangs up or the call is answered. Exceptions: This value is ignored if `algo = al`, or `interval = *` (but it must be present and should be set to 1).
- `cfwd=target`: If the call is unanswered and the maximum hunting duration has been met, the call is forwarded to the specified number. When forwarding the call, the device sends a 302 response to the ITSP.

**NOTE**

- The call forward settings for the individual stations are ignored during hunting. Instead, the call forward settings in the Contact List are used.
- You cannot forward from one hunt group to another hunt group.

Examples for Hunt Rules

- Contacting a group of stations simultaneously

Global Rule: `500:name="Sales",101,102,103,hunt=al`

Line-Specific Rule: `101,102,103,hunt=al`

For the global rule, this hunt group is assigned an extension number (500) and is given a name, Sales. For both examples, the rule includes three stations (101, 102, 103). An incoming call rings all three stations simultaneously (`hunt=al`).

- Using wildcard characters to specify a range of station numbers

Global Rule: 500:name="TechSupport",1*,hunt=a1

Line-Specific Rule: 1*,hunt=a1

In this example, the * symbol is a wildcard character that represents any number of digits. An incoming call simultaneously rings all stations that begin with the number 1.

- Creating multiple hunt groups with the pipe character

Global Rule: 500:name="TechSupport",101,102,103,hunt=a1 | 600:name="AccountSupport",2*,hunt=a1

Line-Specific Rule: 101,102,103,hunt=a1 | 2*,hunt=a1

Two hunt groups are created. One hunt rule applies to stations 101, 102, and 103. The other hunt rule applies to all stations that begin with the number 2.

- Ringling stations sequentially with call forwarding to the Auto Attendant

Global Rule: 300:name="TechSupport",101,102,100,hunt=re;20;2,cfwd=aa

Line-Specific Rule: 101,102,100,hunt=re;20;2,cfwd=aa

An incoming call is routed sequentially from the beginning of the list (hunt=re). Every new call is routed to the first station, 101. If the call is unanswered, it cycles to station 102 and then to station 100. Each phone rings for 20 seconds (20). After 2 cycles, an unanswered call is forwarded to the Auto Attendant (cfwd=aa).

- Ringling stations randomly with call forwarding to voice mail

Global Rule: 400:name="Sales",101,102,103,hunt=ra;30;1,cfwd=vm2100

Line-Specific Rule: 101,102,103,hunt=ra;30;1,cfwd=vm2100

An incoming call is routed in random order (hunt=ra). A new call is routed to a randomly chosen station. If the call is unanswered, it cycles through the stations in random order. Each phone rings for 30 seconds (30). After 1 cycle is completed, an unanswered call is forwarded to the voice mail for station 100, where Line 2 is configured for the voice mail service (1,cfwd=vm2100).

- Resuming from a previous hunt with call forwarding to a receptionist

Global Rule: 500:name="Scheduling",102,103,101,hunt=ne; 45;240,cfwd=100

Line-Specific Rule: 102,103,101,hunt=ne; 45;240,cfwd=100

An incoming call is routed in “next station” order (`hunt=ne`). When a new call is received, the system resumes the previous hunt. For example, suppose that station 103 answered the most recent call to the group. A new call is routed to the next station in the list, which is station 101. If the call is unanswered, then it cycles to station 102, and so on. Each phone rings for 45 seconds (`45;`). After a total of 240 seconds has elapsed, the call is forwarded to station 100 (`240,cfwd=100`).

Creating a Hunt Rule

Use the following procedure to create a global hunt rule or a line-specific hunt rule.



NOTE For information about creating a hunt rule within a Contact list, see [Managing Inbound Calls with the Contact List, page 85](#).

-
- STEP 1** Start Internet Explorer, and then enter the IP address of the SPA9000. Click **Admin Login** and then click **Advanced**.
- STEP 2** Proceed as needed, depending on the type of hunt rule:
- **Global Rule:** Click **Voice tab > SIP**. Scroll down to the **PBX Parameters** section. Find the **Hunt Groups** field.
 - **Line-Specific Rule:** Click **Voice tab > Line N**, where *N* is the line interface number. Scroll down to the **Subscriber Information** section. Find the **Contact List** field.
- STEP 3** Type your hunt group rule. See “[Syntax for Hunt Rules,](#)” on page 93 and “[Examples for Hunt Rules,](#)” on page 94.
- STEP 4** Click **Submit All Changes**. The phones reboot.

STEP 5 To verify the settings:

- **Global Rule:** Place a call to the new hunt group by entering the extension number or by using the Corporate Directory to select the group name and dial the group.
 - **Line-Specific Rule:** From an external phone, such as a cellular phone, place a call to the phone number that is associated with the line interface. Verify that the call is routed according to the specified settings.
-

Managing Inbound Calls with Shared Line Appearances

A shared line appearance (SLA) allows multiple stations to share an extension number and to manage a call as a group.

About Shared Line Appearances

An incoming call to an SLA causes all stations to ring simultaneously. The phones display the line status, such as idle, ringing, or busy.

Be aware of the following factors:

- If a shared line is being used by one of the stations in the group, no one can use the corresponding line key until the line is released. A message appears on the phone display to indicate that a shared call is active.
 - All stations with a line key for the SLA can monitor the status based on the appearance of the line key button:
 - Green: The SLA is available.
 - Flashing Red Quickly: A call is ringing the SLA and has not been answered.
 - Flashing Red Intermittently: A call is active at another station.
 - Flashing Red Slowly: A call is on hold.
 - Solid Red: A call is active on this station.
 - All stations with a display can monitor the status of any SLA that is configured. The icon next to the line key will change to show ringing, off-hook, or busy "<-->" until the phone is back on-hook.
 - Comparing the SLA to a Hunt Group, both may ring several stations simultaneously. However, only one station in a Hunt Group can answer and manage the call. For more information, see [“Managing Inbound Calls with Hunt Groups,” on page 92.](#)
-

STEP 1 Start Internet Explorer, and then enter the IP address of the SPA9000. Click **Admin Login** and then click **Advanced**.

STEP 2 Choose the client station that you want to configure:

- a. Click the **PBX Status** link near the top right corner or lower left corner of the page to view the list of client stations.
- b. Click the hyperlink in the *IP Address* column for the first phone that you want to configure. The telephone configuration page appears in a separate browser window.

STEP 3 Configure the shared extension on the selected station:

- a. Click the tab for the extension that you want to configure (*Ext 1 ... Ext n*, depending on the phone model).



NOTE As a general practice, Cisco recommends that you always reserve Extension 1 on the client station as the primary and private extension of the designated user.

- b. Scroll down to the *Share Line Appearance* section, and then enter the following settings:

- **Share Ext:** Choose **shared**.
- **Shared User ID:** Enter a user ID number for this SLA. After the line key is configured, this ID will appear on the phone display and in the Corporate Directory.

SPA9xx Telephone Configuration > Ext: Shared Line Appearance

Share Line Appearance	
Share Ext:	shared
Shared User ID:	200
Subscription Expires:	3600

- c. Scroll down to the *Subscriber Information* section, and then enter a User ID and Display Name for this shared extension.

SPA9xx Telephone Configuration > Ext: Subscriber Information

Subscriber Information			
Display Name:	<input type="text"/>	User ID:	100
Password:	<input type="text"/>	Use Auth ID:	no
Auth ID:	<input type="text"/>		
Mini Certificate:	<input type="text"/>		
SRTP Private Key:	<input type="text"/>		

- d. Scroll down the *Proxy and Registration* section, and enter the same *Proxy* value as on the primary extension for this station.

SPA9xx Telephone Configuration > Ext: Proxy and Registration

Proxy and Registration			
Proxy:	192.168.0.109:6060	Use Outbound Proxy:	no
Outbound Proxy:	<input type="text"/>	Use OB Proxy In Dialog:	yes
Register:	yes	Make Call Without Reg:	no
Register Expires:	3600	Ans Call Without Reg:	no
Use DNS SRV:	no	DNS SRV Auto Prefix:	no
Proxy Fallback Intvl:	3600	Proxy Redundancy Method:	Normal

STEP 4 Configure a line key button for the shared extension:

- a. Click the **Phone** tab.
- b. Scroll down to the *Line Key* area for the line key button that you want to configure (*Line 1 ... Line n*, depending on the phone model).
- c. Enter the following settings to correspond with the entries that you made on the Extension tab:
 - **Extension:** From the drop-down list, choose the number corresponding to the *Ext N* tab that you configured for this SLA. For example, if you configured the SLA on the *Ext 2* page, then choose 2 from the *Extension* drop-down list.
 - **Shared Call Appearance:** From the drop-down list, choose shared.
 - **Short Name:** Type the extension number that you entered as the *Shared User ID* for the extension. This extension number will appear on the phone display and in the Corporate Directory.

SPA9xx Telephone Configuration: Ext: Line Key

Line Key 2			
Extension:	2	Short Name:	200
Share Call Appearance:	shared		

-
- STEP 5** If needed, configure additional line keys for the same SLA.
 - STEP 6** Click **Submit All Changes**.
 - STEP 7** Repeat this procedure for each phone that you want to configure with the SLA.
-

Administering the SPA400 and Voice Mail Service

This chapter guides you through the process of configuring and managing the SPA400 for PSTN access and voice mail service.

The SPA400 provides a SIP-PSTN gateway for voice connectivity between the PSTN and the local client stations that are connected to the SPA9000. It also includes an integrated voice mail application that supports up to 32 voice mail accounts with customized greetings, providing the ability to receive and playback voice mail messages.

- [“Connecting to the SPA400 Administration Web Server,”](#) on page 103
- [“Configuring the SPA400 Network Connection,”](#) on page 104
- [“Managing Access to the SPA400 Web-Based Configuration Utility,”](#) on page 106
- [“Upgrading the Firmware for the SPA400,”](#) on page 107
- [“Configuring a SPA400 to Interoperate with the SPA9000,”](#) on page 108
- [“Configuring a SPA400 for Voice Mail Service,”](#) on page 112
- [“Managing the Voice Mail Messages on the USB Key,”](#) on page 121
- [“Enabling Debugging on the SPA400,”](#) on page 122



NOTE Also see:

- [Chapter 8, “Localization”](#) for information about localizing your SPA400 devices
 - [Appendix C, “SPA400 Field Reference”](#) for detailed information about the fields on each page of the SPA400 administration web server
-

Connecting to the SPA400 Administration Web Server

You can manage a SPA400 by using the web-based configuration utility.



NOTE If you have not already done so, connect the SPA400 to the same switch as the SPA9000 and the SPA900 series IP phones. For more information, see the *SPA400 Quick Install Guide*.

STEP 1 Start Internet Explorer, and enter the IP address of the SPA400 that you want to configure.



NOTE By default, the SPA400 is configured to obtain an IP Address via DHCP. You can check the obtained IP address on the router DHCP server's client list.

STEP 2 When the password prompt appears, enter the default user name, **Admin**, with no password. Then click **OK**.

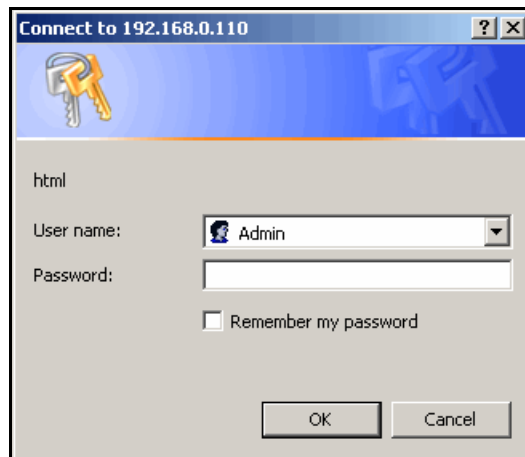

NOTE The user name must be entered exactly as shown: **Admin**. By default, no password is required, but a password can be set on the *Administration > Management* page. See [“Managing Access to the SPA400 Web-Based Configuration Utility,”](#) on page 106.

Configuring the SPA400 Network Connection

The SPA400 becomes a DHCP client of any server on the network. The recommended setting is to use a static IP address. This configuration provides ease of installation and prevents connectivity issues that would occur if the IP address of the SPA400 changed.

STEP 1 Start Internet Explorer, and enter the IP address of the SPA400.



NOTE By default, the SPA400 is configured to obtain an IP Address via DHCP. You can check the obtained IP address on the router DHCP server's client list.

STEP 2 When the password prompt appears, enter the default user name, **Admin**, with no password. Then click **OK**.



NOTE The user name must be entered exactly as shown: **Admin**. For information about access, refer to “[Managing Access to the SPA400 Web-Based Configuration Utility](#),” on page 106.

STEP 3 Click **Setup tab > Basic Setup**.

STEP 4 Enter the following settings:

Network Setup section:

- **Fixed IP address:** Click the radio button, and then enter a valid IP address.



NOTE To avoid addressing conflicts, enter an IP address that is outside the range of addresses that are automatically assigned by your DHCP server.

- **IP Subnet Mask:** Enter the subnet mask for the subnetwork that the SPA400 is on.
- **Gateway IP Address:** Enter the IP address of the router for this subnetwork.

Domain Name Server (DNS) Address section:

- **Primary DNS:** Enter the IP address of the primary DNS server.
- **Secondary DNS:** Enter the IP address of the secondary DNS server.

NTP section:

- **NTP:** Enter a fully qualified name of a Network Time Protocol server, such as time.nist.gov.
- **Time Zone:** Select the time zone for your region.

STEP 5 Click **Save Settings**. The SPA400 will reboot. To reconnect to the web administration server, enter the new IP address for the SPA400 in the browser Address bar.

Saving or Discarding Changes on the SPA400

Changes can be saved or discarded at any time.

- Changes are submitted only when you click the **Save Settings** button at the bottom of a page.
- To discard unsubmitted changes, click the **Cancel Changes** button at the bottom of the page.
- Unsubmitted changes are not retained when you move among the pages.
- After you submit changes in the SIP or Voice mail accounts settings, reboot the SPA400.



TIP Before you make changes, save a copy of your current working configuration:

1. In Internet Explorer, connect to the administration web server.
2. Navigate to the page that has the settings that you want to save.
3. From the menu, choose **File > Save As**.

4. Save the configuration as Web Page Complete. The currently displayed page is saved. You can use the saved file to review the settings as needed.
5. Repeat these steps for each page, as needed.

Managing Access to the SPA400 Web-Based Configuration Utility

One log on can be established for access to the SPA400 web-based configuration utility. The default username of Admin can be changed, and a password can be entered.

STEP 1 Connect to the SPA400 administration web server. (See “Connecting to the SPA400 Administration Web Server,” on page 103.)

STEP 2 Click **Administration tab > Management**.



STEP 3 Proceed as needed:

- **Gateway Username:** Type the desired username in this field, up to 32 characters.
- **Gateway Password:** Type the password.
- **Retype to Confirm:** Type the password again. Both entries must match exactly.

STEP 4 Click **Save Settings**.

STEP 5 To restart the SPA400, complete the following steps:

- a. Click **Administration tab > Reboot**.
- b. Click the **Restart System** button.
- c. When the confirmation message appears, click **OK**. The SPA400 reboots.

- d. When the *Reboot OK. Go to Setup page?* message appears, click **OK** and wait for 60 seconds (the time required for the SPA9000 to re-register with SPA400).

Upgrading the Firmware for the SPA400

As needed, you can download new firmware and then install it on the SPA400.

- STEP 1** Download the latest SPA400 firmware from the following URL:
<http://tools.cisco.com/support/downloads/go/Redirect.x?mdfid=282414117>
- STEP 2** Connect to the SPA400 administration web server. (See “Connecting to the SPA400 Administration Web Server,” on page 103.)
- STEP 3** Click **Administration tab > Firmware Upgrade**.
- STEP 4** Click **Browse**.

SPA400 Administration tab > Firmware Upgrade page

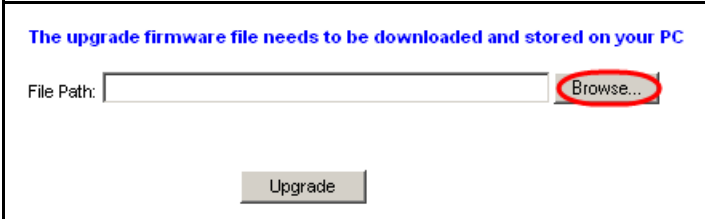

The screenshot shows the SPA400 Administration web interface for the Firmware Upgrade page. At the top, a blue header reads "The upgrade firmware file needs to be downloaded and stored on your PC". Below this, there is a "File Path:" label followed by an empty text input field and a "Browse..." button. The "Browse..." button is circled in red. At the bottom of the form is an "Upgrade" button.

- STEP 5** Find the binary (.bin file) that you extracted to your Desktop, and click **Open**. The selected file appears in the *File Path* field on the *Firmware Upgrade* page.

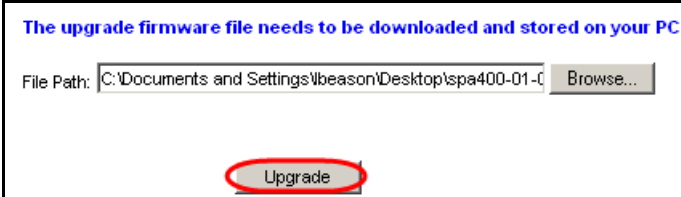

The screenshot shows the SPA400 Administration web interface for the Firmware Upgrade page. At the top, a blue header reads "The upgrade firmware file needs to be downloaded and stored on your PC". Below this, there is a "File Path:" label followed by a text input field containing the path "C:\Documents and Settings\lbeason\Desktop\spa400-01-0" and a "Browse..." button. The "Upgrade" button at the bottom is circled in red.

- STEP 6** Click **Upgrade**.

STEP 7 When the confirmation message appears, click **OK**.



STEP 8 When the *Setup* page reappears, verify that the *Firmware Version* number matches the firmware version that you installed. You have successfully upgraded the firmware.

SPA400 Main Page: Firmware Version



NOTE You may need to refresh your browser to display the updated banner reflecting the new version number.

Configuring a SPA400 to Interoperate with the SPA9000

A SPA400 must be configured to register the SPA9000. To enable the interoperation of the two devices, you need to enter corresponding information on the *SPA9000 Voice > Line* page and on the *SPA400 Setup > SPA9000 Interface* page. For voice mail service, additional entries are needed on the *SPA400 Setup > Voicemail Server* page.

Be aware of the following factors:

- You need to complete this procedure for each SPA400, whether it is used as a PSTN gateway or as a voice mail server.
- You need to configure a SPA9000 line interface for each SPA400. See “[Configuring a Line Interface for a SPA400 \(PSTN or Voice Mail\)](#),” on page 60.



TIP If you install multiple SPA400 units, keep track of the MAC addresses to ensure that you know which device you are configuring. In the administration web server, you can see the MAC address by clicking the Status tab.

STEP 1 Connect to the SPA400 administration web server. (See “[Connecting to the SPA400 Administration Web Server](#),” on page 103.)

STEP 2 When the password prompt appears, enter the user name and password. Then click OK.



NOTE For more information about the administrator account, see “[Managing Access to the SPA400 Web-Based Configuration Utility](#),” on page 106.

STEP 3 Click **Setup tab > SPA9000 Interface**.

STEP 4 Enter the following settings:

- **User ID: 9000**
This is the user ID that the SPA9000 will use to register with the SPA400. Any ID can be used, but must match exactly the User ID that you entered on the corresponding *SPA9000 Voice > Line* page.
- **SPA9000 Address:** Select the **Discover Automatically** radio button (required for SPA9000 operation).
This setting enables the SPA400 to learn the IP address and the UDP port of the SPA9000 the from the SIP Registration packets sent by SPA9000.
- **Call Signalling Packets: 68**
- **RTP Packets: b8**
- Leave the *Signalling Port* at the default value of **5060**. This port is the source port that is used to originate signaling between the SPA400 and the SPA9000.
- Leave the *RTP Port* at the default value of 10000. This port is the base UDP port for the block of UDP ports that the SPA400 uses to send and receive RTP and RTCP packets.

- Leave the *Session Timer* fields at the default values: Enabled with 0 seconds in both Refresh Time fields.

STEP 5 Click **Save Settings** at the bottom of the page.

STEP 6 Click **Setup tab > Voice**.

STEP 7 Enter the following settings:

- **Preferred Codec:** Select **G.711u**.
- **Packetization:** Choose **30ms** from the *Packetization* drop-down list for G.711U.
- **VAD:** Choose **OFF** from the *VAD* drop-down list for G.711U.

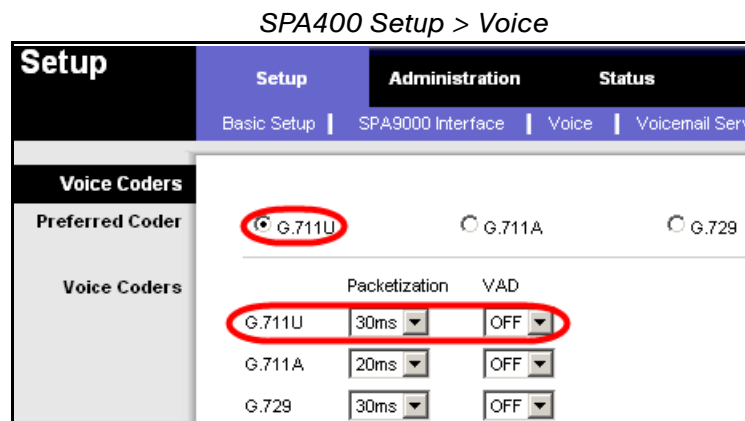

STEP 8 Click **Save Settings** at the bottom of the page.

STEP 9 To restart the SPA400, complete the following steps:

- Click **Administration tab > Reboot**.
- Click the **Restart System** button.
- When the confirmation message appears, click **OK**. The SPA400 reboots.
- When the *Reboot OK. Go to Setup page?* message appears, click **OK**.

STEP 10 If you are using this SPA400 as a PSTN gateway, connect the RJ11 cables from the SPA400 to the wall outlet for PSTN access.

STEP 11 To verify your progress, perform the following tasks:

- Click the **Status** tab, and confirm that the SIP registration status is Registered.
- If you connected PSTN lines to the ports on the SPA400, confirm that you can place an external call to the phone number that is associated with the PSTN

line. The call is directed according to the Contact List. Also, in the SPA400 web configuration page, click the **Status** tab, and then verify that a voltage value appears in the *Battery Level* section.

SPA400 Administration > Status: Battery Level

Battery Level	Line 1:	-49 V
	Line 2:	0 V
	Line 3:	0 V
	Line 4:	0 V



NOTE If the battery level is 0 V on a line that you have connected to the PSTN, troubleshoot the phone wiring.

- Connect to the SPA9000 administration web server, and choose Admin access with Advanced settings. Click **Voice tab > Info**. Scroll down to the *Line 2 Status* section, and verify that the *Registration Status* is *Registered*.

STEP 12 Click **Save Settings**.



NOTE If you are using this SPA400 for voice mail service, continue to “[Configuring a SPA400 for Voice Mail Service](#),” on page 112.

Configuring a SPA400 for PSTN Access

Typically, there is no need to change the default settings on the *Voice* page. Make changes only if a problem is suspected and only after consulting with a service technician from your telephone service provider. It is essential that the settings on your system are compatible with those of the Central Office.

Configuring a SPA400 for Voice Mail Service

The SPA400 includes a USB adapter with an integrated voice mail application for the users and extensions that are configured on the SPA9000. The integrated voice mail application server supports 32 configurable voice mail accounts. Although a SPA9000 can be configured with up to four SPA400 devices, only one SPA400 can be configured with the voice mail server.



NOTE Important: For optimum voice mail performance, a SPA400 should be dedicated to the voice mail application when either of the following conditions is met:

- 1) More than 2 FXO connections are required

—OR—

- 2) More than 2 users commonly access voice mail at the same time.

This section includes the following topics:

- “Voice Mail Capacity,” on page 112
- “Configuring Local Voice Mail Service on a SPA400,” on page 113
- “Setting Up Voice Mail on Each Station,” on page 116
- “Enabling Remote Voice Mail Access (Optional),” on page 119



NOTE Before you begin any of the procedures in this section, configure a SPA9000 line interface for this device. See “Configuring a Line Interface for a SPA400 (PSTN or Voice Mail),” on page 60.

Voice Mail Capacity

The provided 128-Mb USB drive can store more than 3.8 hours of messages (approximately 230 60-second messages). For example, with 10 voice mail users, each user can store up to 23 60-second messages. When disk capacity is reached, inbound voice mail deposit attempts are disconnected. If additional voice mail storage is required, please contact Linksys for recommended high-capacity USB drives.

Configuring Local Voice Mail Service on a SPA400

You need to configure the voice mail server and set up the voice mail boxes for the users.



NOTE The settings on this page correspond to the settings on the *SPA9000 Voice > Line* page. See “Configuring a Line Interface for a SPA400 (PSTN or Voice Mail),” on page 60.

SPA400 > Setup > Voicemail Server

SPA9000 > Voice > Line N

<p>Server Port: <input type="text" value="5090"/></p> <p>SPA9000 subscriber ID: <input type="text" value="8888"/></p> <p>Mailbox deposit number: <input type="text" value="900"/></p> <p>Mailbox manage number: <input type="text" value="800"/></p> <p>A.A Language: <input type="text" value="English"/></p> <p>Maximum length of a voicemail message: <input type="text" value="60"/></p>	<table border="1"> <thead> <tr> <th colspan="2">Proxy and Registration</th> </tr> </thead> <tbody> <tr> <td>Proxy:</td> <td>192.168.0.110</td> </tr> <tr> <td>Outbound Proxy:</td> <td></td> </tr> <tr> <td>Use Outbound Proxy:</td> <td><input type="text" value="no"/></td> </tr> <tr> <td>Register:</td> <td><input type="text" value="yes"/></td> </tr> <tr> <td>Register Expires:</td> <td>30</td> </tr> <tr> <td>Use DNS SRV:</td> <td><input type="text" value="no"/></td> </tr> <tr> <td>Proxy Fallback Intvl:</td> <td>3600</td> </tr> <tr> <td>Mailbox Status:</td> <td>103:0/0,102:3/0,100:0</td> </tr> <tr> <td>Mailbox Deposit URL:</td> <td>900@192.168.0.110:50</td> </tr> <tr> <td>Mailbox Manage URL:</td> <td>800@192.168.0.110:50</td> </tr> <tr> <td>CFWD Bridge Mode:</td> <td><input type="text" value="all"/></td> </tr> <tr> <td>Use OB Proxy In Dialog:</td> <td></td> </tr> <tr> <td>Make Call Without Reg:</td> <td></td> </tr> <tr> <td>Ans Call Without Reg:</td> <td></td> </tr> <tr> <td>DNS SRV Auto Prefix:</td> <td></td> </tr> <tr> <td>Proxy Redundancy Method:</td> <td></td> </tr> <tr> <td>Mailbox Subscribe URL:</td> <td></td> </tr> <tr> <td>Mailbox Subscribe Expires:</td> <td></td> </tr> <tr> <td>VMSP Bridge:</td> <td></td> </tr> <tr> <td>XFER Bridge Mode:</td> <td></td> </tr> </tbody> </table>	Proxy and Registration		Proxy:	192.168.0.110	Outbound Proxy:		Use Outbound Proxy:	<input type="text" value="no"/>	Register:	<input type="text" value="yes"/>	Register Expires:	30	Use DNS SRV:	<input type="text" value="no"/>	Proxy Fallback Intvl:	3600	Mailbox Status:	103:0/0,102:3/0,100:0	Mailbox Deposit URL:	900@192.168.0.110:50	Mailbox Manage URL:	800@192.168.0.110:50	CFWD Bridge Mode:	<input type="text" value="all"/>	Use OB Proxy In Dialog:		Make Call Without Reg:		Ans Call Without Reg:		DNS SRV Auto Prefix:		Proxy Redundancy Method:		Mailbox Subscribe URL:		Mailbox Subscribe Expires:		VMSP Bridge:		XFER Bridge Mode:	
Proxy and Registration																																											
Proxy:	192.168.0.110																																										
Outbound Proxy:																																											
Use Outbound Proxy:	<input type="text" value="no"/>																																										
Register:	<input type="text" value="yes"/>																																										
Register Expires:	30																																										
Use DNS SRV:	<input type="text" value="no"/>																																										
Proxy Fallback Intvl:	3600																																										
Mailbox Status:	103:0/0,102:3/0,100:0																																										
Mailbox Deposit URL:	900@192.168.0.110:50																																										
Mailbox Manage URL:	800@192.168.0.110:50																																										
CFWD Bridge Mode:	<input type="text" value="all"/>																																										
Use OB Proxy In Dialog:																																											
Make Call Without Reg:																																											
Ans Call Without Reg:																																											
DNS SRV Auto Prefix:																																											
Proxy Redundancy Method:																																											
Mailbox Subscribe URL:																																											
Mailbox Subscribe Expires:																																											
VMSP Bridge:																																											
XFER Bridge Mode:																																											

STEP 1 Connect to the SPA400 administration web server. (See “Connecting to the SPA400 Administration Web Server,” on page 103.)

STEP 2 Click **Setup tab > Voicemail Server**.

STEP 3 Enter the following information:

- **Server Port: 5090**
The voice mail server uses this UDP port to listen for signalling between the SPA400 and the SPA9000. This port must be different from the port number that you entered on the SPA9000 Interface page.
- **SPA9000 subscriber ID: 8888**
The SPA9000 uses the subscriber ID to subscribe to the SPA400 Voice mail Server for obtaining notification.

- **Mailbox deposit number: 900**
The SPA9000 uses the deposit number to deposit voice mail on the voice mail server.
- **Mailbox manage number: 800**
The SPA9000 uses the deposit number to access voice mail on the voice mail server.

SPA400 Setup > Voicemail Server: Voicemail Setting

STEP 4 Click **Save Settings**.

STEP 5 Configure the voice mail users (required):

- a. Click the **Voicemail Users** tab.
- b. Enable the voice mail accounts and enter the user's extensions and passwords:
 - **Enable:** Select the check box to enable the voice mail account.
 - **User ID:** Enter the user's extension number.
 - **Password:** Enter a password for this user. Users can change their own passwords after logging on with the assigned password.

SPA400 Setup > Voicemail Users



NOTE Later you configure each client station for voice mail access to the mail boxes that you create on this page.

STEP 6 Click **Save Settings** at the bottom of the page.

STEP 7 Restart the SPA400 by completing the following steps:

- a. Click **Administration tab > Reboot**.
- b. Click the **Restart System** button.
- c. When the confirmation message appears, click **OK**. The SPA400 reboots.
- d. When the *Reboot OK. Go to Setup page?* message appears, click **OK**.

STEP 8 To verify your progress, click the **Status** tab, and verify the following settings:

- **USB status:** Mount
- **Voice mail status:** OK
- **SPA9000 Registration status:** Registered

SPA400 Status

Gateway Information	
Firmware Version:	1.0.0.9
MAC Address:	00:18:39:23:C5:9C
Current Time:	Wed Jan 2 10:59:38 2008
Internet Connection	
IP Address:	192.168.0.110
IP Subnet Mask:	255.255.255.0
Gateway IP Address:	192.168.0.1
Primacy DNS:	192.168.0.1
Secondary DNS:	
SPA400 Status	
USB status:	Mount
Voice mail status:	OK
USB capacity status:	used 1952 kb, remaining 123720 kb
SIP registration status:	Registered



NOTE If the SPA registration status is not Registered, trying powering off the SPA9000 and powering it on again.

- STEP 9** Continue to the next procedure, “Setting Up Voice Mail on Each Station,” on page 116.

Setting Up Voice Mail on Each Station

You need to set up each station that needs to have a voice mailbox. Perform this procedure after you have configured both the SPA400 and the SPA9000.

- STEP 1** Connect to the SPA9000 administration web server. (See “Connecting to the SPA9000 Administration Web Server,” on page 27.)
- STEP 2** Click the **PBX Status** link near the top right corner or lower left corner of the page. The screen lists each phone by Station Name and Extension number.

SPA9000 PBX Status

Registration	Station	User ID	IP Address	Reg Expires(s)	User-Agent
<input type="checkbox"/>	000e08df14c5	100	192.168.1.137	76	Linksys/SPA942-5.2.8
<input type="checkbox"/>	000e08df14cd	101	192.168.1.134	76	Linksys/SPA942-5.2.8
<input type="checkbox"/>	000e08dc3f65	102	192.168.1.105	57	Linksys/SPA942-5.2.8
<input type="checkbox"/>	000e08dc3e8f	103	192.168.1.107	78	Linksys/SPA942-5.2.8
<input type="checkbox"/>	000e08df4e9a	104	192.168.1.101	89	Linksys/SPA942-5.2.8

- STEP 3** Find the phone that you want to configure, and then click the hyperlink in the *IP Address* column. The *Telephone Configuration* page appears in a separate browser window.

SPA9xx Telephone Configuration > Info

Info	System	SIP	Provisioning	Regional	Phone	Ext 1	Ext 2	Ext 3	Ext 4	User	User Person
System Information											
DHCP:	DHCP			Current IP:	192.168.0.1						
Host Name:	SipuraSPA			Domain:							
Current Netmask:	255.255.255.0			Current Gateway:	192.168.0.1						
Primary DNS:	192.168.0.1										
Secondary DNS:											
Product Information											
Product Name:	SPA-942			Serial Number:	4L000G8073						
Software Version:	5.1.15(a)			Hardware Version:	1.0.2(73e6)						
MAC Address:	000E08DF14C5			Client Certificate:	Installed						
Customization:	Open			Licenses:	None						

STEP 4 To assign a station name, complete the following steps:

- a. Click the **Phone** tab.
- b. In the *General* section, type a name in the *Station Name* field.

SPA9xx Telephone Configuration > Phone: General

General			
Station Name:	Accounting	Voice Mail Number:	vmm
Text Logo:			
BMP Picture Download URL:			
Select Logo:	Default	Select Background Picture:	None
Screen Saver Enable:	no	Screen Saver Wait:	300
Screen Saver Icon:	Background Picture		



NOTE This setting assists you in managing the phones. The station name appears on the phone display, in the Corporate Directory, and in features such as Group Call Pickup, that list the participating phones in a menu.

STEP 5 To assign a voice mail box to the primary extension, complete the following steps:

- a. Click the **Ext 1** tab.
- b. Scroll down to *Call Feature Settings*.
- c. Enter the *Mailbox ID* in the following format:

<lineN><mailbox>

Example: 2105

- **lineN**: The SPA9000 line (1, 2, 3, or 4) that is configured with the voice mail settings
In the example, 2 is the number of the SPA9000 line interface that is configured for the SPA400 voice mail server.
- **mailbox**: The voice mailbox number for this station, as configured on the SPA400 *Voice Mail Users* page.
In the example, voice mailbox 105 is assigned to the station.



NOTE The mailbox value corresponds to a User ID on the SPA400 voice mail server.

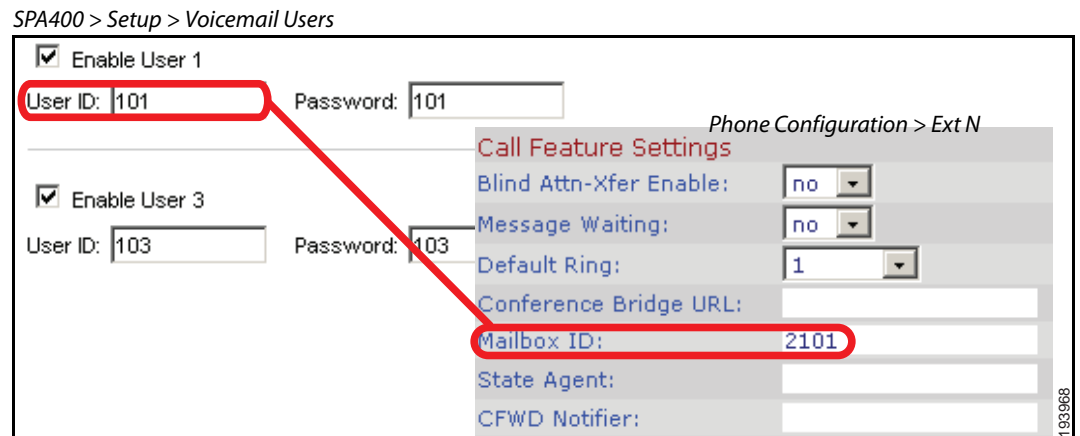

STEP 6 Click **Submit All Changes**. The phone reboots.

STEP 7 Close the browser window for this station.

STEP 8 Return to the browser window that shows the list of stations, and then repeat this procedure for each station that you need to configure.



NOTE When you finish configuring stations, you can click the **Back** button on the browser toolbar to return to the main web configuration page.

STEP 9 To verify your progress, perform the following tasks:

- **Station Name:** Verify that the station name appears on the phone display and in the list of stations on the PBX Status page.
- **Mailbox Status:** Connect to the SPA9000 administration web server, and choose Admin access with Advanced settings. Click **Voice tab > Line 2**. In the *Proxy and Registration* section, check the *Mailbox Status* field. You should see a listing for each extension that you configured with voice mail. Refer to the following example.

SPA9000 Voice > Line: Proxy and Registration

Proxy and Registration				
Proxy:	192.168.0.110			
Outbound Proxy:				
Use Outbound Proxy:	no	Use OB Proxy In Dialog:	yes	
Register:	yes	Make Call Without Reg:	no	
Register Expires:	30	Ans Call Without Reg:	no	
Use DNS SRV:	no	DNS SRV Auto Prefix:	no	
Proxy Fallback Intvl:	3600	Proxy Redundancy Method:	Normal	
Mailbox Status:	103:0/0,102:0/0,SPA9		Mailbox Subscribe URL:	8888@192.168.0.110:5
Mailbox Deposit URL:	900@192.168.0.110:50		Mailbox Subscribe Expires:	30
Mailbox Manage URL:	800@192.168.0.110:50		VMSB Bridge:	None

- **Voice Mail:** Press the **Message** button. You hear one of the following responses:
 - “Password”: If you are prompted for a password, the station is configured properly. You can enter the password and manage the mailbox.
 - “Mailbox number”: If you are prompted for the mailbox number, a mailbox is not assigned to this station. Review the settings on the SPA400 Voice mail User page (see [“Configuring Local Voice Mail Service on a SPA400,”](#) on page 113) and the Phone configuration page (see [“Setting Up Voice Mail on Each Station,”](#) on page 116).
 - Busy Tone: A busy tone indicates a problem with the configuration. Verify that the USB drive is properly inserted into the SPA400, and review the various entries that you made in the configuration.

Enabling Remote Voice Mail Access (Optional)

You can configure the SPA9000 to allow the users to check their voice mail when they are out of the office.



NOTE If your users will call into your voice mail system through an ITSP line, your ITSP must support out-of-band DTMF (IE RFC2833).

STEP 1 Connect to the SPA9000 administration web server. (See [“Connecting to the SPA9000 Administration Web Server,”](#) on page 27.)

STEP 2 Click **Voice tab > SIP**.

STEP 3 Scroll down to the *Auto Attendant Parameters* section.

STEP 4 Edit the *AA Dial Plan 1* string to include a code for the voice mail server, as described below.

- **SYNTAX:** (10x|xxx.|<dialcode:vmmN>)
- **EXAMPLE:** (10x|xxx.|<8:vmm2>)
- **dialcode:** The digit that users dial, when prompted by the Auto Attendant, to access voice mail remotely.



NOTE The Contact List for this line must be configured for the Auto Attendant to answer.

- **MailboxManageNumber:** The Mailbox Manage Number that was entered on the SPA400 Voice mail Settings page. If you followed the instructions in the procedure “[Configuring a SPA400 to Interoperate with the SPA9000](#),” on [page 108](#), you set 800 as the Mailbox Manage Number.
- **vmmN:** Replace *N* with the number of the SPA9000 line interface (Line 1 ... Line 4) that is configured for the SPA400 voice mail server.

STEP 5 Copy and paste the same string into the **AA Dial Plan 2** field, for the purpose of allowing remote access of voice mail at all times of day. For more information about AA Dial Plans, refer to “[Configuring Dial Plans for the Auto Attendant](#),” on [page 150](#).

STEP 6 Click **Voice tab > Line N**, where *N* is the number of the line interface for this SPA400 unit.

STEP 7 Make sure that the *VMSP Bridge*, *XFER Bridge Mode*, and *CFWD Bridge Mode* fields are set to **all**.

STEP 8 Click **Submit All Changes**. The SPA9000 and the phones reboot.

STEP 9 To verify your progress, perform the following tasks:

- a. Dial into the site from an external number.
- b. When the Auto Attendant prompts you for an extension, press 8.
- c. When the Voice Mail Server prompts for a mailbox number, enter the mailbox number.
- d. When prompted for a password, enter the password.

Managing the Voice Mail Messages on the USB Key

To delete unneeded voice mail messages on the USB key, refer to the procedure below.



NOTE When you click the Reset button, all the voice mail message for all users will be deleted. The deleted voicemail messages are not recoverable.

STEP 1 Connect to the SPA400 administration web server. (See “Connecting to the SPA400 Administration Web Server,” on page 103.)

STEP 2 Click **Administration tab > USB Setting**.

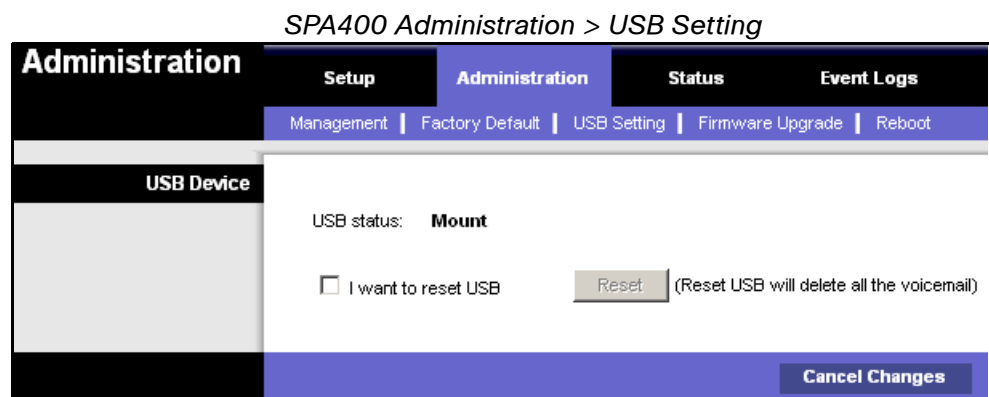

STEP 3 Check the *I want to reset USB* check box.

STEP 4 Click **Reset**.

STEP 5 When the confirmation message appears, click **OK** to continue or click **Cancel** to end the operation without deleting the messages.

Enabling Debugging on the SPA400

If you are investigating issues, you can collect system logs and debug information for the SPA400.

Requirements:

- You need a PC that is on the same subnetwork as the SPA9000, to capture the log files. This PC needs to be running a syslog daemon. Enter the IP address of this PC on the *Voice > System* page, in the *Syslog Server* and *Debug Server* fields.
- You can deploy a syslog server to receive syslog messages from the device, which acts as a syslog client. The syslog client device uses the syslog protocol to send messages, based on its configuration, to a syslog server. The syslog messages can be accessed by reviewing the "syslog.514.log" file which resides in the same directory as the slogsrv.exe syslog server application.



NOTE Partners can download the Syslog Server for SPA Devices by going to Cisco Partner Central, Voice & Conferencing page, Technical Resources section. Use the following URL:

www.cisco.com/web/partners/sell/smb/products/voice_and_conferencing.html#~vc_technical_resources

-
- STEP 1** Connect to the SPA400 administration web server. (See “[Connecting to the SPA400 Administration Web Server](#),” on page 103.)
- STEP 2** Click **Event Logs** tab.
- STEP 3** Use the drop-down lists to choose the types of information that you want to collect.

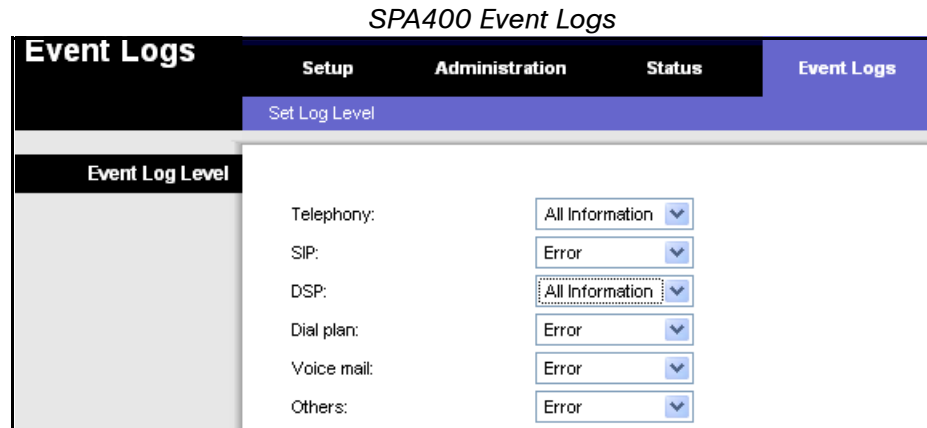

STEP 4 Click **Save Settings**.



NOTE As a best practice, enable logging only when needed, and disable logging when you finish the investigation. Logging information can impact system performance.

STEP 5 Click **Setup tab > Basic Setup**.

STEP 6 In the *Syslog Settings* section, enter the IP address of the *Syslog Server*, which normally is a PC on the same network as the SPA400.

SPA400 Setup > Basic Setup

Setup	Setup	Administration	Status	Event Logs	
	Basic Setup	SPA9000 Interface	Voice	Voicemail Server	Voicemail Users
Network Setup	<input type="radio"/> Dynamic IP Address: (DHCP Client) <input checked="" type="radio"/> Fixed IP Address: 192 . 168 . 1 . 113 IP Subnet Mask: 255 . 255 . 255 . 0 Gateway IP Address: 192 . 168 . 1 . 1				
Domain Name Server (DNS) Address	Primary DNS: 192 . 168 . 1 . 1 Secondary DNS:				
NTP	NTP Server 1: time.nist.gov Time Zone: (GMT-08:00) Pacific Time (USA & Canada)				
Syslog Settings	Syslog Server: 192.168.1.132:1400				

- STEP 7** Start a command prompt on the PC, and run the system logging software.
- STEP 8** Run the scenario that causes the problem and when done, press **CTRL+C** in the command window to stop the logs.
- STEP 9** When you are finished collecting logs, return to the *Event Logs* page and reset the logs to **Off**.

Configuring Music on Hold

This chapter explains how to configure Music on Hold using either a music file or streaming audio.

This chapter includes the following topics:

- “Using the Internal Music Source for Music On Hold,” on page 125
- “Configuring a Streaming Audio Server,” on page 127

Using the Internal Music Source for Music On Hold

An internal music source with the user ID **imusic** is available. It plays an internally stored music file repeatedly. The unit ships with a default music file (*Romance de Amor*). You can override this file by downloading a new file into the unit by using TFTP.

Refer to the following topics:

- “Using the Internal Music Source,” on page 125
- “Changing the Music File for the Internal Music Source,” on page 126

Using the Internal Music Source

To use the internal music source, simply identify **imusic** as the MOH server for each IP phone.

-
- STEP 1** Use the phone menu to find the IP address of the phone:
- Press the **Setup** button on the phone keypad.
 - Press **9 - Network**, and then scroll down to **2- Current IP Address**.

-
- STEP 2** Start Internet Explorer, and then enter the IP address of the telephone. The Telephone Configuration page appears in a separate browser window.
 - STEP 3** Click **Admin Login**, and then click **Advanced**.
 - STEP 4** Click the **Ext 1** tab.
 - STEP 5** Scroll down to the *Call Feature Settings* section.
 - STEP 6** Enter the following value in the *MOH Server* field: **imusic**
 - STEP 7** Click **Submit All Changes**.
 - STEP 8** To verify, place a test call to the extension. When the call is answered and put on hold, the caller should hear the default music file (*Romance de Amor*).
-

Changing the Music File for the Internal Music Source

The following resources are required to change the music file for the internal music source:

- TFTP server software
- The IP address of the administration computer that is connected to the SPA9000
- A music source in G.711u format, sampled at 8000 samples/sec, up to 65.5 seconds in length, with no header information

-
- STEP 1** Before you begin, make sure that you have TFTP server software running on your computer.
 - STEP 2** Start Internet Explorer, connect to the administration web server, and choose Admin access with Advanced settings.
 - STEP 3** Click **Voice tab > SIP**.
 - STEP 4** Scroll down to the *Internal Music Source Parameters* section.
 - STEP 5** Enter the following URL in the Internal Music URL field:
`tftp://server_IPaddress:port/path`
 - `server_IPaddress`: The local IP address of the computer you are using as the TFTP server
 - `port`: The port number used by the TFTP server (default **69**)

- **path:** The location and name of a music file in the correct format
- For example, if the computer local IP address is 192.168.0.5, the directory is named *musicdir*, and the converted music file is named *jazzmusic.dat*, then you would enter the following URL: `tftp://192.168.0.5:69/musicdir/jazzmusic.dat`

STEP 6 Click **Submit All Changes**. The unit reboots. Then the unit downloads the file and stores it in flash memory.

Configuring a Streaming Audio Server

This section describes how to use and configure a streaming audio server (SAS). It includes the following topics:

- “About the Streaming Audio Server,” on page 127
- “Configuring the Streaming Audio Server,” on page 129
- “Using the IVR with an SAS Line,” on page 130

About the Streaming Audio Server

The Streaming Audio Server (SAS) feature lets you attach an audio source to an FXS port and use it as a streaming audio source device. If the unit has multiple FXS ports, either or both of the associated lines can be configured as an SAS server.

Use a media signal adapter or “music coupler” to connect an Ethernet cable from a media source to the FXS port. For example, the MC-9700 Music Coupler has been tested with ATA devices and is available at the following URL:

[www.neogadgets.com/cart/
cart.php?target=product&product_id=17&substring=music+coupler](http://www.neogadgets.com/cart/cart.php?target=product&product_id=17&substring=music+coupler)

After you complete the required configuration, the FXS port is ready to stream audio. The functionality depends on the hook state of the FXS port:

- If the FXS port is off hook, an incoming call is answered automatically and audio is streamed to the calling party.



NOTE Each SAS server can maintain up to five simultaneous calls. If the second line on the unit is disabled, then the SAS line can maintain up to 10 simultaneous calls. Further incoming calls receive a busy signal (SIP 486 Response).

- If the FXS port is on-hook when the incoming call arrives, a SIP 503 response code is transmitted to indicate “Service Not Available.”
- If an incoming call is auto-answered, but later the FXS port changes to on-hook, the call is not terminated but continues to stream silence packets to the caller.
- The SAS line can be set up to refresh each streaming audio session periodically using a SIP re-INVITE message, which detects if the connection to the caller is down. If the caller does not respond to the refresh message, the SAS line terminates the call so that the streaming resource can be used for other callers.

Additional information:

- The SAS line does not ring for incoming calls even if the attached equipment is on-hook.
- If no calls are in session, battery is removed from tip-and-ring of the FXS port. Some audio source devices have an LED to indicate the battery status. This can be used as a visual indication as to whether audio streaming is in progress.
- Call Forwarding, Call Screening, Call Blocking, DND, and Caller-ID Delivery features are not available on an SAS line.

Configuring the Streaming Audio Server

Use the following procedure to configure an SAS with an external music source.

-
- STEP 1** Connect an RJ-11 adapter between the music source (a CD player or iPod, for example) and an FXS port.
- STEP 2** Start Internet Explorer, connect to the administration web server, and choose Admin access with Advanced settings.
- STEP 3** Configure the FXS port:
- Click **Voice tab > FXS *N***, where *N* represents the number of the FXS port where you connected the cable from the external music source.
 - In the *Subscriber Information* section, enter the following settings:
 - **Display Name:** Enter an extension number of name for the FXS 1 port, such as Receptionist Area Fax Machine.
 - **User ID:** Enter a three- to four-digit extension number that is not is use by another extension.
 - In the *Streaming Audio Server (SAS)* section, choose **yes** from the **SAS Enable** drop-down list.
- STEP 4** Click **Submit All Changes**.
- STEP 5** Configure each phone to use this audio source as the MOH server:
- Click the **PBX Status** link to view the list of phones.
 - In the list, find the phone that you want to configure, and then click the hyperlink in the *IP Address* column. The Telephone Configuration page appears in a separate window.
 - Click the **Ext 1** tab.
 - Scroll down to the *Call Feature Settings* section.
 - In the *MOH Server* field, enter the extension number that you assigned to the FXS port for the streaming audio server.
 - Click **Submit All Changes**.

- g. Close the window for the Telephone Configuration page.
 - h. Repeat this step to configure each phone, as needed.
-

Using the IVR with an SAS Line

The IVR can still be used on an SAS line, but the user needs to follow the following steps:

- STEP 1** Power off the SPA9000.
- STEP 2** Connect a phone to the port and make sure the phone is on-hook.
- STEP 3** Power on the SPA9000.
- STEP 4** Pick up handset and press * * * * to invoke IVR in the usual way.

If the SPA9000 boots and finds that the SAS line is on-hook, it does not remove battery from the line so that IVR may be used. But if the SPA9000 boots up and finds that the SAS line is off-hook, it removes battery from the line because no audio session is in progress.

Configuring the Auto Attendant

This chapter describes how to configure the SPA9000 Voice System Auto Attendant (AA) by using the IVR and XML scripting.

This chapter contains the following sections:

- “How the Auto Attendant Works,” on page 131
- “Working with the Auto Attendant Greetings,” on page 133
- “Writing an Auto Attendant Script,” on page 138
- “Configuring the DayTime, NightTime and Weekend/Holiday Auto Attendants,” on page 148
- “Configuring Dial Plans for the Auto Attendant,” on page 150

How the Auto Attendant Works

The Auto Attendant (**aa**) is an internal service within the SPA9000. This service answers calls and plays pre-recorded voice messages that offer a menu of choices. The Auto Attendant parses the user input (key presses or DTMF tones), based on the Auto Attendant Dial Plan. Finally, the Auto Attendant routes the call to the selected extension.

The Auto Attendant can handle up to ten incoming calls simultaneously. It can accommodate two categories of callers:

- Callers who do not call you regularly or are not accustomed to using Auto-Attendants. The Auto Attendant plays a greeting and provides menus to help callers reach the desired extension.
- Callers who call you regularly and want to move through the system quickly. The Auto Attendant allows experienced users to input their responses at any time.

The Auto Attendant relies upon the following components:

- **Contact List.** When a call comes in, the SPA9000 directs the call according to the entries in the Contact List for the line interface. By default, the Auto Attendant is the only client on this list, so the Auto Attendant picks up every call. Alternatively, you can enter a list of client stations to alert, with the Auto Attendant picking up a call only if a number (or group) of clients did not pick up the call first. This parameter is configured on the *Voice > Line N* page, *Subscriber Information* section, *Contact List* field. For more information, see [“Managing Inbound Calls with the Contact List,” on page 85.](#)
- **Recorded Prompts.** The Auto Attendant plays prompts to assist the users. The system includes a set of pre-recorded prompts, and you can record your own custom prompts. For more information, see [“Working with the Auto Attendant Greetings,” on page 133.](#)
- **AA Script.** This XML script determines which prompt is used to greet callers and which prompts are played in response to valid or invalid user inputs. You can enter up to three scripts. One script is active at any time. These scripts are configured on the *Voice > SIP* page, *Auto Attendant Parameters* section, *AA Script 1 - 3* fields. For more information, see [“Writing an Auto Attendant Script,” on page 138.](#)
- **DayTime, NightTime, and Weekend/Holiday AA.** You can activate different AA scripts for different times of day. By default, the DayTime AA settings are activated and use AA Script 1. As needed, you can activate the NightTime AA and the Weekend/Holiday AA, with your selection of a script (AA Script 1, 2, or 3). You also need to define the start and end time for daytime, nighttime, and weekend/holiday. For more information, see [“Configuring the DayTime, NightTime and Weekend/Holiday Auto Attendants,” on page 148.](#)
- **AA Dial Plan.** The Auto Attendant parses the user input according to the dial plan that is identified in the AA script. You can create up to two dial plans. These dial plans are configured on the *Voice > SIP* page, *Auto Attendant Parameters* section, *AA Dial Plan 1 - 2* fields. See [“Configuring Dial Plans for the Auto Attendant,” on page 150.](#)

Working with the Auto Attendant Greetings

This section provided information about adding, and editing the Auto Attendant greetings. See the following topics:

- “Using Pre-Recorded Prompts,” on page 133
- “Recording an Auto Attendant Prompt,” on page 134
- “Downloading Prompts,” on page 137

Using Pre-Recorded Prompts

You can save up to ten Auto Attendant prompts. Four pre-recorded prompts are provided, as listed in the following table.

Table 1 Default AA Prompts

Prompt ID	Default Audio Content
Prompt1	“If you know your party’s extension, you may enter it now.”
Prompt2	“Your call has been forwarded.”
Prompt3	“Not a valid extension, please try again.”
Prompt4	“Goodbye.”



NOTE These prompts are available in languages other than English. See “[Localizing the SPA9000 Auto Attendant Prompts](#),” on page 151.

You can replace the pre-recorded prompts with your own recordings, and you can add up to six additional recordings. For example, you may want to change the default prompt, Prompt 1, to greet callers with your company name. You may want to record a different prompt for nighttime or holiday hours. You can make these recordings by using the IVR. The recordings are encoded with G.711U and saved in flash.

Recording an Auto Attendant Prompt

Follow this procedure to overwrite an existing recording or to add a new recording.



NOTE Customized prompts are erased when a factory reset is performed on the SPA9000.

STEP 1 Connect an analog phone to the Phone 1 or Phone 2 port of the SPA9000.

STEP 2 Press the star key (*) four times: * * * *

The IVR plays the following prompt: *Linksys configuration menu. Please enter the option followed by the # (pound) key or hang up to exit.*

STEP 3 Press **72255#** to access the Auto Attendant message settings.

The IVR plays the following prompt: *Please enter the message number followed by the # (pound) key.*

STEP 4 Enter the number of the message (1 through 10) that you wish to record, review, or delete.

The IVR plays the following prompt: *Enter 1 to record. Enter 2 to review. Enter 3 to delete. Enter * to exit.*

STEP 5 Press **1** to record a new message.



NOTE The IVR checks the available buffer size. If there is no more buffer capability, IVR plays the *Option Failed* message and returns to the previous menu.

If the buffer space is sufficient, the IVR plays the following prompt: *You may record your message after the tone. When finished, press #.*

STEP 6 After the tone, record the new message and then press #.

The IVR plays the following prompt: *To save, enter 1. To review, enter 2. To re-record, enter 3. To exit, enter *.*

STEP 7 Press **1** to save the new recorded message.

The IVR plays the following prompt: *One moment, please.*

STEP 8 Wait for several seconds while the save is completed.

Example Prompts

In this example, the business will have different Auto Attendant Scripts for different times of day.

Table 2 Example AA Prompts

Prompt ID	Message
Prompt1	"If you know your party's extension, you may enter it now."
Prompt2	"Your call has been forwarded."
Prompt3	"Not a valid extension, please try again."
Prompt4	"Goodbye."
Prompt5	"Welcome to All Seasons Travel."
Prompt6	"Thank you for calling All Seasons Travel. Presently we are closed."
Prompt7	"We are open Monday through Friday 9 AM to 6 PM, and we are closed on Saturdays and Sundays. Our address is 101 Main Street, Anytown, Anystate, USA."
Prompt8	"If you know your party's three-digit extension, you may enter it now."
Prompt9	"To reach our receptionist, press 0 at any time. For our company location, press 1. For travel support, press 2. For sales, press 3. Otherwise, please stay on the line for our receptionist."
Prompt10	"Welcome to the All Seasons Travel support line. If this is regarding our Holiday Getaway Special, please press 1; otherwise, please stay on the line for one of our travel associates. Or press * to go back."

For examples of AA scripts that use custom prompts, see ["An Introduction to XML Scripting Grammar in AA Script Examples,"](#) on page 138.

Using the IVR Prompts to Change Recordings

The IVR prompts guides you through the process of recording, erasing, and changing greetings. Refer to the following illustration.

Figure 1 IVR Prompt Menu Call Flow

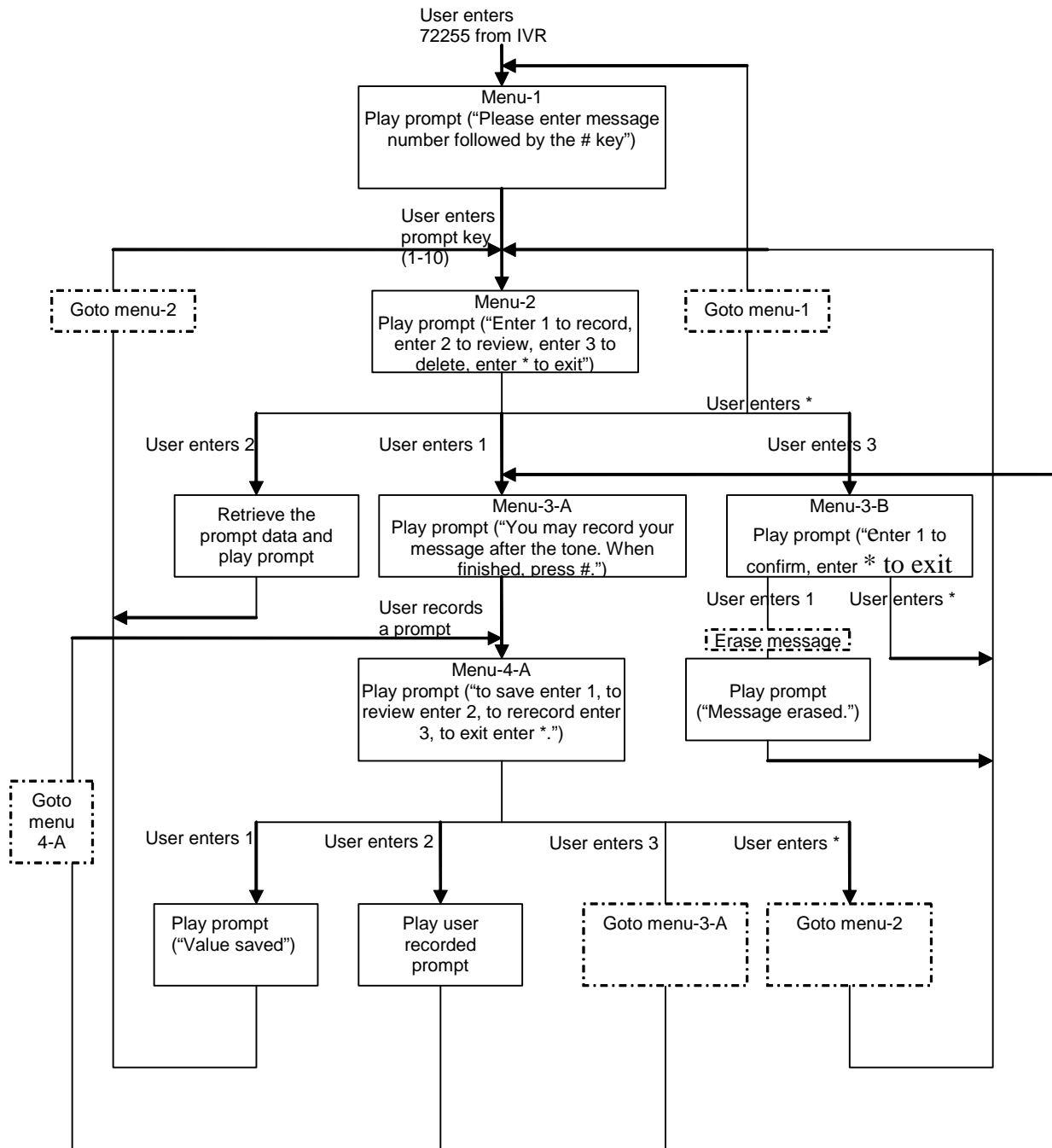

Downloading Prompts

You can download customized prompt files from a TFTP/HTTP/HTTPS server. These files must be encoded in G.711u, size less than 60 seconds, with the header removed. The total prompt file size cannot be larger than 94.5 seconds.

The prompt is downloaded at the device boot up time. If the prompt has already been downloaded from the given URL, the download is not performed. If the prompt file name is **none**, the corresponding prompt currently saved in the flash is erased. The default value is blank.

-
- STEP 1** Connect to the administration web server, and choose Admin access with Advanced settings.
 - STEP 2** Click **Voice tab > SIP**.
 - STEP 3** Scroll down to the *Auto Attendant Parameters* section.
 - STEP 4** In the *AA Prompts URL Script* field, enter the location and the file name for the prompts files, in the following format:

SYNTAX:

```
serv=scheme://server_addr[:port]/root_path;[p1={prompt1 file
path name};][p2={prompt2 file path name};][p3={prompt3 file
path name};][p4={prompt4 file path name};][p5={prompt5 file
path name};][p6={prompt6 file path name};][p7={prompt7 file
path name};][p8={prompt8 file path name};][p9={prompt9 file
path name};][p10={prompt10 file path name};]
```

- scheme = tftp|http|https
- default port is 69 for tftp, 80 for http, and 443 for https
- root_path can be empty
- [] denotes optional item
- none: The prompt will be erased.

EXAMPLE:

```
serv=tftp://192.168.2.150/root/
test;p1=menu.wav;p2=transfer.wav; p3=nomatch.wav;p4=none;
```

In this example, Prompt 1 is downloaded from tftp://192.168.2.150/root/test/menu.wav, Prompt 2 from tftp://192.168.2.150/root/test/transfer.wav, and Prompt 3 from tftp://192.168.2.150/root/test/nomatch.wav. Prompt 4 is erased.

STEP 5 Click **Submit All Changes**.

Writing an Auto Attendant Script

The SPA9000 AA allows users to define the AA instructions using XML script. This section includes the following topics:

- “An Introduction to XML Scripting Grammar in AA Script Examples,” on page 138
- “Elements of XML Scripting Grammar ,” on page 142
- “Auto Attendant XML Instructions Set,” on page 145
- “Entering an Auto Attendant Script,” on page 147

An Introduction to XML Scripting Grammar in AA Script Examples

The SPA9000 lets you use XML scripting grammar to define the Auto Attendant instructions. You can study the example scripts to learn about the scripting grammar. You also may find it helpful to use these scripts as the basis for your own custom scripts. Also see “Elements of XML Scripting Grammar ,” on page 142.

Example 1: Routing Calls to Any Extension Number (Default AA Script 1)

In this example, the business is using the default AA Script 1, which prompts the caller to enter any extension number. Each part of the script is described in the following table.

Table 3 Elements of the Default AA Script 1

Script Elements	Purpose
<code><aa></code>	This script is for the AA.
<code><form id="dir" type="menu"></code>	This form is given the name “dir” for directory, and it is a menu type of form, which accepts DTMF inputs.

Script Elements	Purpose
<pre><audio src="prompt1" bargein="T"/></pre>	<p>The Auto Attendant plays Prompt 1, using the default recording: <i>If you know your party's extension, you may enter it now.</i></p> <p>Callers are allowed to begin dialing (bargein) at any time.</p>
<pre><noinput timeout="10" repeat="T"/></pre>	<p>If there is no input after 10 seconds, the Auto Attendant repeats the menu prompt.</p>
<pre><dialplan src="dp1"/></pre>	<p>AA Dial Plan 1 is used to evaluate the inputs.</p>
<pre><nomatch repeat="F"> <audio src="prompt3" bargein="T"/> </nomatch></pre>	<p>If the dialed digits do not match the dial plan, the Auto Attendant plays Prompt3: <i>Not a valid extension, please try again.</i></p>
<pre><match> <default> <audio src="prompt2"/> <xfer name="ext" target="\$input"/> </default> </match></pre>	<p>If the dialed digits match the dial plan, the Auto Attendant plays Prompt 2 (<i>Your call has been forwarded.</i>) The call is transferred to the extension number that the user entered.</p>
<pre></form></pre>	<p>The form is ended.</p>
<pre></aa></pre>	<p>The script is ended.</p>

Example 2: Routing Calls with a Departmental Sub-Menu

In this example, the business wants to expedite the handling of sales calls. A custom prompt is used to give special instructions about calls for the sales department. A sub-menu for the sales group is provided to direct calls to the correct person within that department.

Table 4 Elements of an AA Script with a Sub-Menu

Script Elements	Purpose
<aa>	This script is for the AA.
<form id="DIR" type="menu">	This form is given the name "DIR" for Directory. It is a menu type of form, which accepts DTMF inputs.
<audio src="prompt1" bargein="T"/>	The Auto Attendant plays custom Prompt1. <i>Welcome to ABC company. For Sales, enter 1. If you know your party's extension, you may enter it now.</i> Callers are allowed to begin dialing (bargein) at any time.
<dialplan src="dp1"/>	Dial plan 1 is used to evaluate the inputs within this form.
<noinput timeout="10" repeat="T"/>	If there is no input after 10 seconds, the Auto Attendant repeats the menu prompt.
<nomatch> <audio src="prompt3" bargein="T"/> </nomatch>	If the user input does not match the specified dial plan, the Auto Attendant plays Prompt3: <i>Not a valid extension, please try again.</i>

Script Elements	Purpose
<pre> <match> <case input="1"> <goto next="SALES" /> </case> <default> <audio src="prompt2" /> <xfer name="ext" target="\$input" /> </default> </match> </pre>	<p>If the user input matches the dial plan, the response depends upon the user entry:</p> <ul style="list-style-type: none"> ■ If the user pressed 1, the Auto Attendant processes the input by using the Sales sub-menu (below in this script). ■ If the user pressed any keys other than 1, the Auto Attendant plays Prompt 2 (<i>Your call has been transferred.</i>) The call is transferred to the extension number that the user entered.
<pre> </form> </pre>	<p>The "DIR" form is closed.</p>
<pre> <form id="SALES" type="menu"> </pre>	<p>This part of the script contains the "SALES" sub-form.</p>
<pre> <audio src="prompt5" /> </pre>	<p>The Auto Attendant plays custom Prompt 5: <i>Press 1 for price info, press 2 for return, press 0 for sales representative, press * to exit.</i></p>
<pre> <dialplan src="dp2" /> </pre>	<p>AA Dial Plan 2 is used to evaluate the inputs. within this form.</p>
<pre> <noinput timeout="10" repeat="T" /> </pre>	<p>If there is no input after 10 seconds, the Auto Attendant repeats the menu prompt.</p>
<pre> <nomatch> <audio src="prompt3" bargin="T" /> </nomatch> </pre>	<p>If the user input does not match the specified dial plan, the Auto Attendant plays Prompt3: <i>Not a valid extension, please try again.</i></p>

Script Elements	Purpose
<pre> <match> <case input="*"> <audio src="prompt4"/> <exit/> </case> <default> <audio src="prompt2"/> <xfer name="ext" target="\$input"/> </default> </match> </pre>	<p>If the user input matches the dial plan, the response depends upon the user entry:</p> <ul style="list-style-type: none"> ▪ If the user presses *, the Auto Attendant plays Prompt 4: <i>Good-bye</i>. ▪ If the user presses any digits other than *, the Auto Attendant plays Prompt 2 (<i>Your call has been transferred</i>.) The call is transferred to the extension number that the user entered.
<pre> </form> </pre>	The form is ended.
<pre> </aa> " </pre>	The script is ended.

Elements of XML Scripting Grammar

This section includes the following topics:

- “Audio Instruction,” on page 142
- “Action Instruction,” on page 143
- “Noinput Instruction ,” on page 143
- “Nomatch Instruction,” on page 144
- “Menu Matched Instruction for Touch Tone (DMTP) Input,” on page 144

Audio Instruction

The following is an example of the **audio** instruction:

```
<audio src= "prompt1" bargein= "T"/>
```

The Auto Attendant plays the audio file that is specified in the *src* attribute. When playing the audio, the Auto Attendant allows the caller to interrupt the current prompt by pressing digits when the *bargein* attribute is set to **T**. The Auto Attendant ignores any digits from the caller if *bargein* is set to **F**. The default value of the *bargein* attribute is **T**.



TIP Generally, enter an audio instruction as the first element in the script. In a `<form>` dialog, if `<audio>` dialog is not been defined, the Auto Attendant does not play a prompt. If it is defined, the Auto Attendant first plays the specified prompt, then executes the action instruction that is described in the next section.

Action Instruction

The actions include:

- **goto**—The Auto Attendant proceeds to the next dialog in the script. All dialogs are identified by the attribute “id”. The value in the id attribute must be unique. Otherwise, the Auto Attendant selects the last valid dialog as the transfer target dialog.

EXAMPLE: `<goto link= "dir_dlg">`

- **xfer**—The Auto Attendant blind transfers the caller to the target.

EXAMPLE: `<xfer name= "Technical Support" target= "5000"/>`

The name attribute is optional. The target attribute must be a valid target phone number.

- **exit** —When this action is reached, the Auto Attendant is stopped, and the call ends.

EXAMPLE: `</exit>`



NOTE In one dialog, only one action can be defined. After the **xfer** or **exit** action is performed, the Auto Attendant ends automatically.

Noinput Instruction

The `<noinput>` dialog can only be used in the menu dialog and is optional. When it is specified, Auto Attendant executes the audio and action instructions if the user does not input any digits with the value of the `<timeout>` parameter, in seconds.

If the **repeat** attribute is set to **T**, the Auto Attendant plays the menu prompt after playing the prompt specified in the `<noinput>` dialog and ignores the action instruction. If the value is **F**, the Auto Attendant executes the **action** instruction. The default value of the **repeat** attribute is **F**.

Either the **audio** or the **action** instruction can be empty. If both are empty, the Auto Attendant does nothing and waits for user input.

Nomatch Instruction

The <nomatch> dialog can be used only in a menu dialog and is optional. This dialog is activated when DTMF digits do not match the dial plan. When the **nomatch** condition is met, Auto Attendant executes the **audio** and **action** instructions in the <nomatch> dialog. If the **repeat** attribute is set to **T**, the Auto Attendant plays the menu prompt after playing the no input prompt and ignores the **action** instruction. If the **repeat** attribute is set to **F**, the Auto Attendant executes the **action** instruction. The default value of the **repeat** attribute is **F**.

Either the **audio** or **action** instruction can be empty. If both are empty, the Auto Attendant does nothing and ignores all buffered digits.

Menu Matched Instruction for Touch Tone (DMTP) Input

The <match> dialog can be used only in the menu dialog and it is a mandatory field. When the DTMF digits match the dialplan, the <match> dialog is activated. The Auto Attendant compares each <case> dialog and executes the corresponding audio/action instructions. If the Auto Attendant cannot find a match in any <case> dialogs, it performs the <default> dialog audio/action instruction if <default> is defined; otherwise, the Auto Attendant ends.

You can specify exact numbers, (for example 1, 23, 1234 and so on), in the **input** attribute of the <case> dialog, or you can use the dial pattern (for example, "50xx", "408xxx5061", "xx."). The user can also combine several dial patterns together and use "|" to separate them (for example, "50xx|408xxx5061|1234").

The user can use the variable "\$input" in the target attribute of the **xfer** action. The value of this variable means that the input value that is already passed by the dialplan. The Auto Attendant does no translation, but directly transfers the call to the target.

EXAMPLE

```
<default>
  <audio src="prompt2" />
  <xfer name="ext" target="$input" />
</default>
```

Outband DTMF (INFO/AVT) is recognized by Auto Attendant. To enable the recognition of inband DTMF, go to the *Voice > SIP* page, *Auto Attendant Parameters* section, and set *AA Decode Inband DTMF* to *yes*.

Auto Attendant XML Instructions Set

The complete set of XML instructions for Auto Attendant Scripts are described in the following table:

Table 5 AA XML Elements

Instruction	Description	Syntax and Example(s)
dialplan	This determines the dialplan id of the current menu <form>. The Auto Attendant processes the user input according to the dial plan and then is dispatched to the match, nomatch, or noinput instruction.	<pre><dialplan src = "dp1"/> "dp1" matches the AA Dial Plan 1 parameter found on the Voice - SIP screen of the administration web server. "dp2" matches the AA Dial Plan 2 parameter found on the Voice - SIP screen of the administration web server.</pre>
noinput	When specified, the Auto Attendant executes the specified audio and action instructions if the user does not input any digits in <timeout> seconds. If the repeat attribute is set to "T", then the Auto Attendant plays the menu prompt after playing the prompt specified in the <noinput> audio instruction and ignore the action instruction; otherwise, the Auto Attendant executes the action instruction. By default, "repeat" is "F".	<pre><noinput timeout="5" repeat="T"> <!--audio instruction (optional) --> <!--action instruction (optional) --> </noinput></pre>
nomatch	When specified, the nomatch instruction runs when the user input digits do not match anything in the dial plan. The Auto Attendant executes the specified audio and action instructions. If the repeat attribute is set to "T", the Auto Attendant plays the menu prompt after playing the no input prompt and ignore the action instruction; otherwise, the Auto Attendant executes the action instruction. By default, "repeat" is "F".	<pre><nomatch repeat="F"> <!--audio instruction (optional) --> <!--action instruction (optional) --> </nomatch></pre>

Instruction	Description	Syntax and Example(s)
match	<p>Upon a match between the user input and the dial plan, the Auto Attendant transfers to the corresponding <case> and execute the corresponding audio and/or action instructions. If the Auto Attendant cannot find a match in any of the <case> statements, it performs the <default> case.</p>	<pre><match > <case input= "x"/> <!--audio instruction (optional) --> <!--action instruction (optional) --> </case> <case input= "#"/> <!--audio instruction (optional) --> <!--action instruction (optional) --> </case> <default> <!--audio instruction (optional) --> <!--action instruction (optional) --> </default> </match></pre>
	<p>goto</p> <p>The Auto Attendant transfers the caller from one <form> to the other <form>. All <form>s are identified by the attribute "id". The value in the id attribute must be unique; otherwise, the Auto Attendant selects the last valid <form> as the transfer-to target.</p>	<pre><goto link= "daytime"></pre> <p>"daytime" is the id of a <form> entry. Example: <form id="daytime" type="menu"></p>
	<p>xfer</p> <p>The Auto Attendant performs a blind transfer of the caller to the target, and then it ends processing "target = \$input" is equivalent to the input value already passed by the dialplan. There is no significance to the name attribute.</p>	<pre><xfer name= "Technical Support" target= "5000"/></pre>
	<p>exit</p> <p>When this action is reached, the Auto Attendant stops, and the call ends</p>	<pre><exit></pre>

Instruction	Description	Syntax and Example(s)
audio	The Auto Attendant plays the audio specified in the “src” attribute. This attribute must be prompt<n>, with <n> being a number in the range 1–10. When playing the audio, the Auto Attendant allows the caller to interrupt the current prompt by pressing digits if the bargein attribute is set to “T”. The Auto Attendant ignores any digits from the caller if the bargein attribute is set to “F” (the default value).	<pre data-bbox="1101 359 1404 415"><audio src= "prompt1" bargein= "T"/></pre>

Entering an Auto Attendant Script



TIP To get started, you may want to copy the default script from the *Voice > SIP* page, *Auto Attendant Parameters* section, *AA Script 1* field. You can paste it into any word processing application, where you can see the entire script more easily. Make your changes, remove any formatting such as line breaks, and paste the final string into the appropriate AA Script field.

- STEP 1** Connect to the SPA9000 administration web server, and choose Admin access with Advanced settings. (See [“Connecting to the SPA9000 Administration Web Server,”](#) on page 27).
- STEP 2** Click **Voice tab > SIP**.
- STEP 3** Scroll down to the *Auto Attendant Parameters* section.
- STEP 4** Enter your script in the appropriate field: *AA Script 1 - 3*. For more information, see [“Writing an Auto Attendant Script,”](#) on page 138.
- STEP 5** Click **Submit All Changes**.

Configuring the DayTime, NightTime and Weekend/Holiday Auto Attendants

You can customize the Auto Attendant with prompts and actions for different times of day and for the days when the business is closed.



NOTE By default, the DayTime Auto Attendant is activated, using AA Script 1, an answer delay of 0 seconds, and no start or end time.

STEP 1 Connect to the SPA9000 administration web server, and choose Admin access with Advanced settings. (See “[Connecting to the SPA9000 Administration Web Server](#),” on page 27).

STEP 2 Click **Voice tab > SIP**.

STEP 3 Scroll down to the *Auto Attendant Parameters* section.

STEP 4 To set up the DayTime Auto Attendant, complete the following tasks:

- *DayTime AA*: Choose **yes** from the drop-down list.
- *DayTime AA Script*: Choose **1, 2, or 3** from the drop-down list.
- *DayTime*: Enter the start and end times in 24-hour format
SYNTAX: `start=hh:mm:ss;end=hh:mm:ss`
EXAMPLE: `start=08:30:00;end=18:00:00`
In this example, the business hours begin at 8:30 a.m. and end at 6:00 p.m.



NOTE When you enter the *DayTime* setting, you are in effect also setting the nighttime hours. There is no separate field for NightTime start and end times.

- *DayTime Answer Delay*: Enter the number of seconds that the Auto Attendant waits before answering a call. This setting is useful when the Auto Attendant is used as a backup tool for a live answerer. For example, assume that the Contact List includes both the receptionist and the Auto Attendant. You might set the Answer Delay to 12 seconds. If the receptionist does not answer within that time, then the Auto Attendant answers the call.

STEP 5 To set up the NightTime Auto Attendant, complete the following tasks:

- *NightTime AA*: Choose **yes** from the drop-down list.
- *NightTime AA Script*: Choose **1, 2, or 3** from the drop-down list.
- *DayTime*: Define the daytime hours, which also defines the nighttime hours. Enter the start and end times in 24-hour format
SYNTAX: `start=hh:mm:ss;end=hh:mm:ss`
EXAMPLE: `start=08:30:00;end=18:00:00`
 In this example, the daytime hours begin at 8:30:00 a.m. and end at 6:00:00 p.m. Nighttime hours begin at 6:00:01 p.m. and end at 8:29:59 a.m.
- *NightTime Answer Delay*: Enter the number of seconds that the Auto Attendant waits before answering a call. Typically the nighttime delay is set to 0 because no one is on site to answer calls.

STEP 6 To set up the Weekend/Holiday Auto Attendant, , complete the following tasks:

- *Weekend/Holiday AA*: Choose **yes** from the drop-down list.
- *Weekend/Holiday AA Script*: Choose **1, 2, or 3** from the drop-down list.
- *Weekends/Holidays*: Define the weekend and holidays, using the following syntax:
`[wk=n1[,ni];][hd=mm/dd/yyyy|mm/dd/yyyy-mm/dd/yyyy[,mm/dd/yyyy|mm/dd/yyyy-mm/dd/yyyy];]`
 - For weekends, the syntax is `wk=n1[,ni]`. In place of `n1`, specify first day of the weekend (1 for Monday, 2 for Tuesday, and so on). If the weekend lasts more than one day, specify the final day of the weekend in place of `n1`. Separate the values with a comma.
 - For holidays, specify each date in `mm/dd` or `mm/dd/yyyy` format (the year is optional). Separate the dates with a comma, or indicate a range of dates with a dash.**EXAMPLE:** `wk=6,7;hd=1/1,2/21/2006,5/30/2006,12/19/2006-12/30/2006`
 In this example, the weekend is defined as Saturday and Sunday. The holidays are Jan. 1 indefinitely; Feb. 21, 2006; May 30, 2006; and Dec. 19-30, 2006.
- *Weekend/Holiday Answer Delay*: Enter the number of seconds that the Auto Attendant waits before answering a call. Typically the weekend delay is set to 0 because no one is on site to answer calls.

STEP 7 Click **Submit All Changes**.

Configuring Dial Plans for the Auto Attendant

Each Auto Attendant script refers to an Auto Attendant Dial Plan to determine how to process the DTMF digits that are entered by the caller. You can define two dial plans on the Voice > SIP page, Auto Attendant Parameters section, *AA Dial Plan 1* and *AA Dial Plan 2* fields.

EXAMPLE 1, Default AA Dial Plan 1: (10x|xxx.)

EXAMPLE 2: (<x:500x>|408555xxxx|xxxxxx)“,
“(<1:1002>|<2:21111>|<3:3333>|xxxxxx)

In this example, when the user inputs DTMF digits, AA parses them using the dial plan first, then the parsing result is directed to the AA script menu instruction.

Localization

This chapter explains how to localize your SPA9000 Voice System with the language files, tones, and ring patterns for your region.

- “Localizing the SPA9000 Auto Attendant Prompts,” on page 151
- “Local Time Configuration,” on page 154
- “Configuring the SPA9000 and SPA9xx Call Progress Tones,” on page 154
- “Localizing the SPA400 Voice Mail Prompts,” on page 160
- “Localizing the SPA400 Call Disconnect Tones,” on page 161
- “Localizing the SPA400 Caller ID Method,” on page 163



NOTE For instructions about localizing the phone display, see the *SPA9x2 Phone Administration Guide*.

Localizing the SPA9000 Auto Attendant Prompts

The default Auto Attendant prompts are in English. You can localize your system by downloading and installing the appropriate language files for your region. Store these prompts on a TFTP/HTTP/HTTPS server, and the SPA9000 will download the files at the device boot up time.



NOTE You need TFTP server software to localize the SPA9000.

The set of files includes the following types of prompts:

- Prompt 1: Greets the caller and prompts for an extension number
- Prompt 2: Notifies the caller that the call is being forwarded
- Prompt 3: Notifies the caller of an invalid extension
- Prompt 4: Good-bye
- Prompt 5: Greets the caller with specific prompts for General Information, Sales, and Support.
- Prompt 6: Notifies the caller that the office is currently closed and prompts for an extension number.



NOTE The Auto Attendant prompt files must be encoded in G.711u and must have a total file size (message and header) of 94.5 seconds or less.

STEP 1 Download the SPA9000 Auto Attendant prompts from Cisco Partner Central, Voice & Conferencing page, Technical Resources section, using the following URL:
www.cisco.com/web/partners/sell/smb/products/voice_and_conferencing.html#~vc_technical_resources

STEP 2 Store the downloaded files on a TFTP/HTTP/HTTPS server.

STEP 3 To configure the SPA9000 to download the files from the server, complete the following tasks:

- a. Start Internet Explorer, and then enter the IP address of the SPA9000. Click **Admin Login** and then click **Advanced**.
- b. Click **Voice tab** > the **SIP** tab.
- c. Scroll down to the *Auto Attendant Parameters* area of the page.
- d. In the *AA Prompts URL* field, enter the script for the server, path, and prompt file names.

SYNTAX:

```
serv=scheme://server_addr[:port]/root_path;[p1={prompt1  
file path name};][p2={prompt2 file path  
name};][p3={prompt3 file path name};][p4={prompt4 file  
path name};][p5={prompt5 file path name};][p6={prompt6
```

```
file path name};][p7={prompt7 file path  
name};][p8={prompt8 file path name};][p9={prompt9 file  
path name};][p10={prompt10 file path name};]
```

- **scheme:** Enter one of the following values: `tftp`, `http`, or `https`.
- **port:** The default ports are 69 for `tftp`, 80 for `http`, and 443 for `https`.
- **root_path** can be empty.
- `[]` denotes an optional item.
- If the prompt file name is **none**, the corresponding prompt currently saved in the flash is erased.

EXAMPLE:

```
serv=tftp://192.168.2.150/root/test/;p1=fr_1.wav;  
p2=fr_2.wav;p3=fr_3.wav;p4=none;
```

STEP 4 Click **Submit All Changes**.

The prompts are downloaded when the SPA9000 boots up. If a prompt has already been downloaded from the given URL, the download is not performed.

STEP 5 To verify that the prompts are localized, make a call to the Auto Attendant. From an internal phone, you can press the **Setup** button, then press **1 - Directory**, then **2 - Corporate Directory**, and then scroll down to find and select the number for the Auto Attendant.

Local Time Configuration

You will need to localize the date, time, and daylight saving time rule. See “[Setting the Date and Time](#),” on page 30 and “[Configuring Daylight Saving Time](#),” on page 31. Use the following table to find the correct Daylight Saving Time Rules for EMEA and Australia.

Table 1 SPA9000 Daylight Saving Time Rules

Country	Daylight Saving Time Rule	Time Zone
Australia (ACST)	start=4/1/7/3;end=10/1/7/2;save=-1	GMT+10:30
Australia (AEST)	start=4/1/7/3;end=10/1/7/2;save=-1	GMT+11
Australia (AWST)	start=3/-1/7/3;end=10/-1/7/2;save=-1	GMT+09:00
France	start=3/-1/7/2;end=10/-1/7/2;save=1	GMT+1
Germany	start=3/-1/7/2;end=10/-1/7/2;save=1	GMT+1
Spain	start=3/-1/7/2;end=10/-1/7/2;save=1	GMT+1
UK/Ireland	start=3/-1/7/2;end=10/-1/7/2;save=1	GMT

Configuring the SPA9000 and SPA9xx Call Progress Tones

Call progress tones, such as dial tone and reorder, indicate the call progress to the users. You can configure your SPA9000 and your SPA9xx phones to use the appropriate call progress tones for your region.

STEP 1 Localize the tones for the SPA9000:

- a. Start Internet Explorer, and then enter the IP address of the SPA9000. Click **Admin Login** and then click **Advanced**.
- b. Click **Voice tab > Regional**.
- c. In the *Call Progress Tones* section, enter the values from Table 3-1 into the corresponding fields.
- d. Click **Submit All Changes**.

STEP 2 Localize the tones for the phones:

- a. Click the **PBX Status** link.
- b. Find the phone that you want to configure, and then click the hyperlink in the *IP Address* column.
- c. Click **Regional**.
- d. In the *Call Progress Tones* section, enter the values from **Table 2, ‘SPA9000 Call Progress Tones by Country,’** on page 155.
- e. Click **Submit All Changes**.
- f. Repeat this step as needed for each phone.

Table 2 SPA9000 Call Progress Tones by Country

Australia	
Dial Tone	400@-19,425@-19;10(*0/1+2)
Outside Dial Tone	420@-16;10(*0/1)
Prompt Tone	520@-19,620@-19;10(*0/1+ 2)
Reorder Tone	425@-19;*(2.5/5)
Off Hook Warning Tone	480@-10,620@0;10(.125/.125/1+2)
Ring Back Tone	400@-19,425@-19;*(.4/.2/1+2,.4/2/1+2)
Busy Tone	425@-16;10(.375/.375/1)
Call Waiting Tone	400@-20;30(0.1/2/1)
Confirm Tone	600@-16;1(.25/.25/1)
Denmark	
Dial Tone	425@-10;*(*/0/1)
Outside Dial Tone	425@-16;10(*0/1)
Prompt Tone	425@-19,620@-19;*(*/0/1+2)
Reorder Tone	425@-10;*(0.25/0.25/1)
Off Hook Warning Tone	425@-10;*(.2/.2/1,.2/.6/1)

Ring Back Tone	425@-10;*(1/4/1)
Busy Tone	425@-10;10(0.25/0.25/1)
Call Waiting Tone	425@-20;30(0.2/0.2/1,0.2/3.6/1,0.2/0.2/1,0.2/0/1)
Confirm Tone	425@-16;1(.25/.25/1)
France	
Dial Tone	440@-10;*(*/0/1)
Outside Dial Tone	440@-16;10(*/*0/1)
Prompt Tone	440@-19,620@-19;*(*/0/1+2)
Reorder Tone	440@-10;*(.5/.5/1)
Off Hook Warning Tone	425@-10;*(.2/.2/1,.2/.6/1)
Ring Back Tone	440@-10;*(1.5/3.5/1)
Busy Tone	440@-10;10(.5/.5/1)
Call Waiting Tone	440@-20;30(.175/.175/1,.175/3.5/1)
Confirm Tone	440@-16;1(.25/.25/1)
Germany	
Dial Tone	425@-10;10(*/*0/1)
Outside Dial Tone	425@-13,400@-13;10(*/*0/1+2)
Prompt Tone	440@-19,620@-19;30(*/*0/1+2)
Reorder Tone	440@-10;*(.5/.5/1)
Off Hook Warning Tone	425@-10;*(.2/.2/1,.2/.6/1)
Ring Back Tone	440@-10;10(1.5/3.5/1)
Busy Tone	425@-10;10(0.48/0.48/1)
Call Waiting Tone	425@-20;30(0.2/0.2/1,0.2/5/1)
Confirm Tone	440@-16;1(.25/.25/1)
Ireland	
Dial Tone	400@-10;*(*/0/1)
Outside Dial Tone	425@-16;10(*/*0/1)

Prompt Tone	425@-19,620@-19;*(*/0/1+2)
Reorder Tone	425@-10;*(0.25/0.25/1)
Off Hook Warning Tone	425@-10;*(.2/.2/1,.2/.6/1)
Ring Back Tone	425@-10;(0.4/0.2/1,0.4/2/1)
Busy Tone	425@-10;10(0.5/0.5/1)
Call Waiting Tone	425@-20;30(0.18/0.2/1,0.2/4.5/1)
Confirm Tone	425@-16;1(.25/.25/1)
Italy	
Dial Tone	425@-10;*(0.2/0.2/1,0.6/1/1)
Outside Dial Tone	425@-16;10(0.2/0.2/1,0.6/1/1)
Prompt Tone	425@-19,620@-19;*(*/0/1+2)
Reorder Tone	425@-10;*(0.2/0.2/1)
Off Hook Warning Tone	425@-10;*(.2/.2/1,.2/.6/1)
Ring Back Tone	425@-10;*(1/4/1)
Busy Tone	425@-10;10(0.5/0.5/1)
Call Waiting Tone	425@-20;30(0.4/0.1/1,0.25/0.1/1,0.15/14/1)
Confirm Tone	425@-16;1(.25/.25/1)
Netherlands	
Dial Tone	425@-10;*(*/0/1)
Outside Dial Tone	425@-16;10(*0/1)
Prompt Tone	425@-19,620@-19;*(*/0/1+2)
Reorder Tone	425@-10;*(0.25/0.25/1)
Off Hook Warning Tone	425@-10;*(.2/.2/1,.2/.6/1)
Ring Back Tone	425@-10;*(1/4/1)
Busy Tone	425@-10;10(.5/.5/1)
Call Waiting Tone	425@-20;30(0.5/9.5/1)
Confirm Tone	425@-16;1(.25/.25/1)

Norway	
Dial Tone	425@-10;*(*/0/1)
Outside Dial Tone	425@-16;10(*0/1)
Prompt Tone	425@-19,620@-19;*(*/0/1+2)
Reorder Tone	425@-10;*(0.2/0.2/1)
Off Hook Warning Tone	1400@-10;*(0.4/15/1)
Ring Back Tone	425@-10;(1/4/1)
Busy Tone	425@-10;10(.5/.5/1)
Call Waiting Tone	425@-20;30(0.2/0.6/1,0.2/10/1)
Confirm Tone	1400@-16;1(20/0/1)
Portugal	
Dial Tone	425@-10;*(*/0/1)
Outside Dial Tone	425@-16;10(*0/1)
Prompt Tone	425@-19,620@-19;*(*/0/1+2)
Reorder Tone	425@-10;*(.2/.2/1,.2/.2/1,.2/.6/1)
Off Hook Warning Tone	425@-10;*(.2/.2/1,.2/.6/1)
Ring Back Tone	425@-10;*(1/5/1)
Busy Tone	425@-10;10(.5/.5/1)
Call Waiting Tone	425@-20;30(0.2/0.2/1,0.2/5/1)
Confirm Tone	425@-16;1(.25/.25/1)
Spain	
Dial Tone	425@-10;*(*/0/1)
Outside Dial Tone	425@-16;10(*0/1)
Prompt Tone	425@-19,620@-19;*(*/0/1+2)
Reorder Tone	425@-10;*(.2/.2/1,.2/.2/1,.2/.6/1)
Off Hook Warning Tone	425@-10;*(.2/.2/1,.2/.6/1)
Ring Back Tone	425@-10;*(1.5/3/1)

Busy Tone	425@-10;10(.2/.2/1)
Call Waiting Tone	425@-20;30(.175/.175/1,.175/3.5/1)
Confirm Tone	425@-16;1(.25/.25/1)
Sweden	
Dial Tone	425@-10;*(*/0/1)
Outside Dial Tone	425@-16;10(*/*0/1)
Prompt Tone	425@-19,620@-19;*(*/0/1+2)
Reorder Tone	425@-10;*(0.25/0.75/1)
Off Hook Warning Tone	425@-10;*(.2/.2/1,.2/.6/1)
Ring Back Tone	425@-10;*(1/5/1)
Busy Tone	425@-10;10(0.25/0.25/1)
Call Waiting Tone	425@-20;30(0.5/9.5/1)
Confirm Tone	425@-16;1(.25/.25/1)
UK	
Dial Tone	350@-10;440@-10;*(*/0/1+2)
Outside Dial Tone	425@-16;10(*/*0/1)
Prompt Tone	400@-19,620@-19;*(*/0/1+2)
Reorder Tone	400@-10;*(0.4/0.35/1,0.225/0.525/1)
Off Hook Warning Tone	425@-10;*(.2/.2/1,.2/.6/1)
Ring Back Tone	400@-10;(0.4/0.2/1,0.4/2/1)
Busy Tone	400@-10;10(0.375/0.375/1)
Call Waiting Tone	400@-20;30(0.1/2/1)
Confirm Tone	400@-16;1(20/0/1)

Localizing the SPA400 Voice Mail Prompts

By default, the voice mail system is configured for the English language. You can localize the system by downloading and installing the appropriate language files for your region.

STEP 1 Download the necessary language files from Cisco Partner Central, Voice & Conferencing page, Technical Resources section, using the following URL:
www.cisco.com/web/partners/sell/smb/products/voice_and_conferencing.html#~vc_technical_resources

STEP 2 To extract the files, complete the following tasks:

- a. Use WinZip to open the sounds.zip file.
- b. Click **Extract** on WinZip toolbar.
- c. Select the Desktop or other temporary destination, select the **Use folder names** check box, and then click **Extract**.

A progress bar appears as the files are extracted. The Sounds folder appears in the selected location.

STEP 3 To move the files to the SPA400 USB drive, complete the following tasks:

- a. Power off the SPA400 by removing the power cord, and then remove the USB drive.
- b. Insert the SPA400 USB drive into a USB port on the PC where you extracted the files.
- c. When the *USB Disk* window appears, click **Open folder to view files using Windows Explorer**, and then click **OK**. The USB drive contains the *spa400vm* folder.



NOTE If the *USB Disk* window does not appear, use Windows Explorer to navigate to the USB disk drive (usually Drive E).

- d. Open *spa400vm\var\lib*. The window displays the *lib* contents, including the *sounds* folder.

- e. If desired, make a backup copy of the existing *sounds* folder.



NOTE You are not overwriting any user message files in this procedure. However, it is a good practice to make a backup copy of your files before doing any upgrades.

- f. Move the new *sounds* folder into *spa400vm\var\lib* on the USB drive. When the *Confirm Folder Replace* window appears, click **Yes to All**.
- g. Remove the USB drive from the PC and insert it into the SPA400.
- h. Power on the SPA400.

STEP 4 Place a test call to the voice mail system to confirm that the new language prompts are used.

Localizing the SPA400 Call Disconnect Tones

One important aspect of VoIP-PSTN integration is the Call Disconnect operation. This operation allows the gateway to detect that the call has been terminated on the other end, so the local line hangs up automatically. Detecting the tone cadence of the Call Disconnect signal is a trigger for closing the loop.

Each country has its own Call Disconnect Signal tone which needs to be configured on the SPA400 *Tone* page. See [Table 3, 'SPA400 Call Processing Tones,'](#) on page 161.

Table 3 SPA400 Call Processing Tones

Country	First Tone		2nd (optional)		3rd (optional)		4th (optional)		Repeat Count
	On (ms)	Off (ms)	On (ms)	Off (ms)	On (ms)	Off (ms)	On (ms)	Off (ms)	
Australia	360	385	360	385					5
Denmark	430	465	430	270					1
France	490	510							1

Country	First Tone		2nd (optional)		3rd (optional)		4th (optional)		Repeat Count
	On (ms)	Off (ms)	On (ms)	Off (ms)	On (ms)	Off (ms)	On (ms)	Off (ms)	
Germany	230	270							1
Ireland	490	510							1
Italy	190	210							1
Netherlands	180	330	180	330					2
Norway	190	210							1
Portugal	190	210							1
Spain	190	210	190	210	200	600			2
Sweden	250	750							1
UK	400	350	225	525					2

STEP 1 Start Internet Explorer, enter the IP address of the SPA400, and log on.

STEP 2 Click the **Tone** tab.

SPA400 Tone page

STEP 3 Enter the appropriate settings for your country, as listed in [Table 3, 'SPA400 Call Processing Tones.](#)

STEP 4 Click **Save Settings**.

STEP 5 On the menu, click **Setup > Voice**.

STEP 6 Scroll down to the *Tear Down FXO Port* field, and enter **0**. Refer to the following illustration.

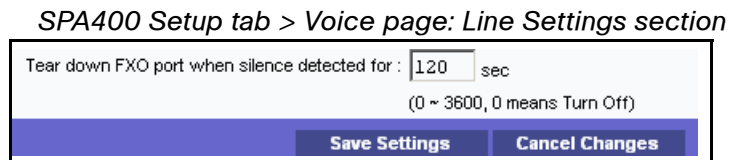

STEP 7 Click **Save Settings**.

STEP 8 To restart the SPA400, complete the following steps:

- a. Click **Administration > Reboot**.
- b. Click the **Restart System** button.
- c. When the confirmation message appears, click **OK**. The SPA400 reboots.
- d. When the *Reboot OK. Go to Setup page?* message appears, click **OK**.

Localizing the SPA400 Caller ID Method

You need to identify the caller ID method to use in your country.

STEP 1 Click **Setup tab > Voice**.

STEP 2 Scroll down to the *Line Settings* section.

STEP 3 From the *Caller Id and CP Tone Method* drop-down list, choose your region.

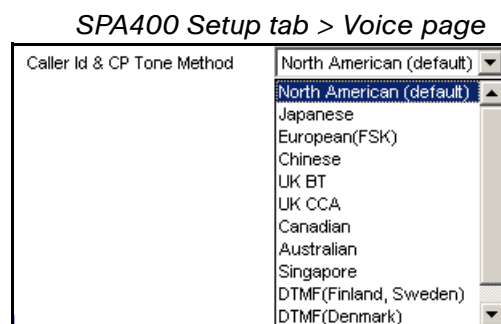



NOTE In the United Kingdom, choose UK BT or UK CCA. In the rest of Europe, choose European (FSK).

STEP 4 Click **Save Settings**.

STEP 5 To restart the SPA400, complete the following tasks:

- a. Click **Administration > Reboot**.
- b. Click the **Restart** button.
- c. When the confirmation message appears, click **OK**. The SPA400 reboots.
- d. When the *Reboot OK* message appears, click **OK**.

STEP 6 To verify your progress, make a call from outside to any of the PSTN lines connected to the SPA400 (make sure that CID is enable in your PSTN line). In the ringing SPA phone display you should now be able to see the number from the calling number.

Advanced Topics in SPA9000 Administration

This appendix provides more detailed technical information for administrators who want to understand how the SPA9000 Voice System works.

- “Technology Background,” on page 165
- “SPA9000 Architecture,” on page 170
- “SIP-NAT Interoperation,” on page 172
- “Advanced Call Control and Routing,” on page 173
- “Configuring Vertical (Supplementary) Service Codes,” on page 173
- “Advanced Topics for SPA400 Voice Mail Service,” on page 178
- “Remote Provisioning Features,” on page 183

Technology Background

This section provides background information about the technology and protocols used by the SPA9000 system. It includes the following topics:

- “Session Initiation Protocol,” on page 166
- “SPA9000 Media Proxy,” on page 167
- “Using the SPA9000 with a Firewall or Router,” on page 168
- “SPA400 SIP-PSTN Gateway,” on page 169

Session Initiation Protocol

The SPA9000 Voice System is implemented using open standards, such as Session Initiation Protocol (SIP), allowing interoperation with all ITSPs supporting SIP. The following figure illustrates a SIP request for connection to another subscriber in the network. In the SIP protocol, the requestor of the session is called the user agent server (UAS), while the receiver of the request is called the user agent client (UAC).

Figure 1 SIP Requests and Responses

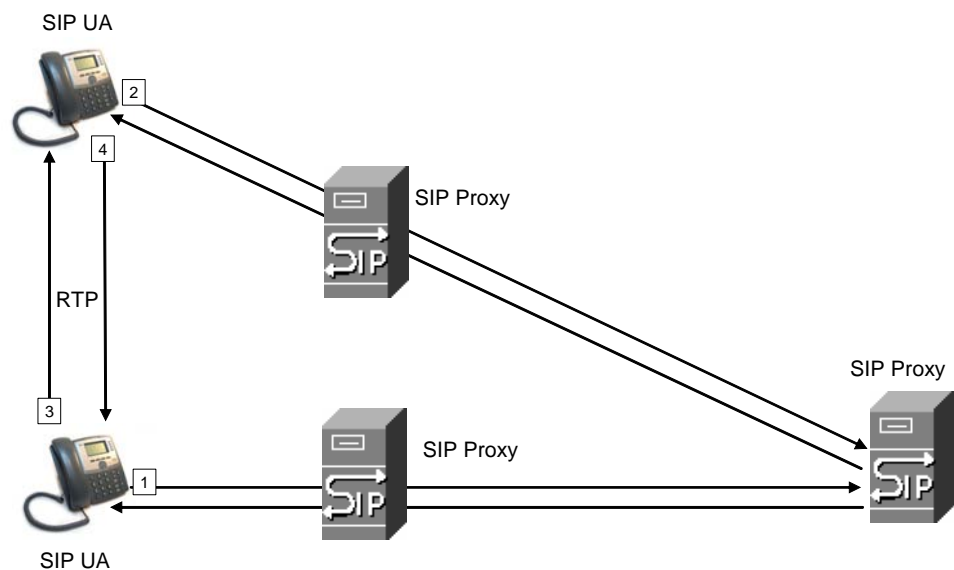

NOTE In this manual, the term client station is used to describe any SIP UA (including IP phones) that registers with the SPA9000.

In a SIP VoIP network, when the SIP proxy receives a request from a client station (UAS) for a connection and it does not know the location of the UAC, it forwards the message to another SIP proxy in the network. Once the UAC is located and the response is routed back to the UAS, a direct peer-to-peer session is established between the two UAs. The actual voice traffic is transmitted between UAs over dynamically assigned ports using the Real-time Protocol (RTP).

In the following figure, UserA and UserB are client stations (UAs) that register over the local area network to which the SPA9000 PBX is connected. When UserA calls UserB, the SPA9000 acts as a SIP proxy and establishes a session between the two UAs. After the session is established, RTP traffic flows directly between the two client stations.

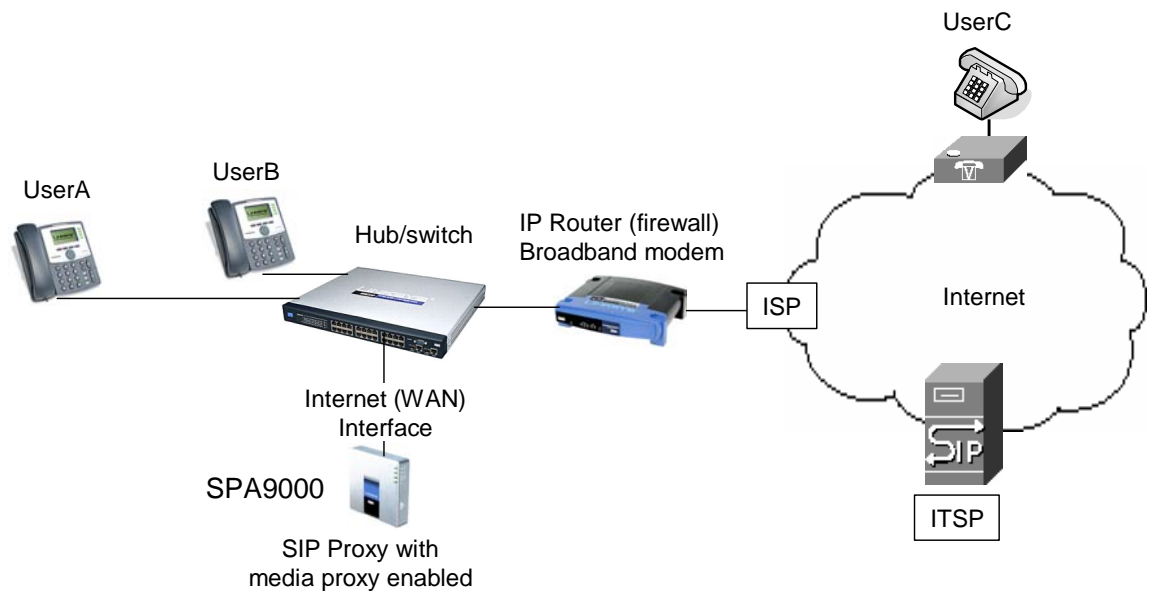
Figure 2 SPA9000 as a SIP Proxy

When a user picks up the handset in an SPA9000 Voice System, the SPA9000 collects DTMF digits from a touchtone analog telephone or the locally connected SPA900 Series IP phones. Unless the call is for a local client station, the SPA9000 system sends the full number in a SIP INVITE message to another SIP proxy server for further call processing.

To minimize dialing delay, a dial plan is maintained that is matched against the cumulative number entered by the user. Invalid phone numbers that are not compatible with the dial plan are detected and the user is alerted using a configurable tone (reorder) or announcement.

The figure also illustrates connectivity between the SPA9000 and the ITSP over the Internet. When UserA calls UserC, the SPA9000 directs the request to the SIP proxy at the ITSP, which is then responsible for routing the request to UserC. Even after the SIP session is established, the SPA9000 continues to direct RTP packets between UserA and the ITSP.

SPA9000 Media Proxy

To address this possible security issue, the SPA9000 can also function as a media (RTP) proxy. This option forces RTP traffic destined for the Internet (or IP WAN) to be directed to the SPA9000, which then directs it to the remote UA. This configuration may simplify firewall configuration because the client stations do not require direct access to the Internet through the firewall.

To enable the media proxy, go to the *Voice > SIP* page, *PBX Parameters* section, and set the *Force Media Proxy* parameter to **True**. With the media proxy enabled, when UserA calls User C, the SPA9000 still acts as the SIP proxy and forwards the request to the SIP server on the ITSP. However, even after the SIP session is established, the SPA9000 continues to direct RTP packets between UserA and the ITSP.

Local traffic is not affected by this configuration. When UserA initiates a call to UserB, RTP traffic still flows directly between the two UAs. The media proxy only affects RTP traffic to a UA connected through the ITSP.

Using the SPA9000 with a Firewall or Router

When using the SPA9000 behind a firewall or router, make sure that the following ports are not blocked:

- SIP ports—By default, UDP ports 5060 through 5063
- RTP ports—16384 to 16482

Also disable SPI if this function exists on your firewall.

SPA400 SIP-PSTN Gateway

When a local user on the SPA9000 network initiates a call to a PSTN subscriber, the SPA400 acts as the SIP-PSTN gateway, which converts the SIP and RTP media packets into the appropriate signal for transmission to the PSTN switch. For example, if UserA calls UserD, the SIP request is routed by the SIP proxy in the SPA9000 to the SPA400.

Figure 3 SPA400 as a SIP-PSTN Gateway

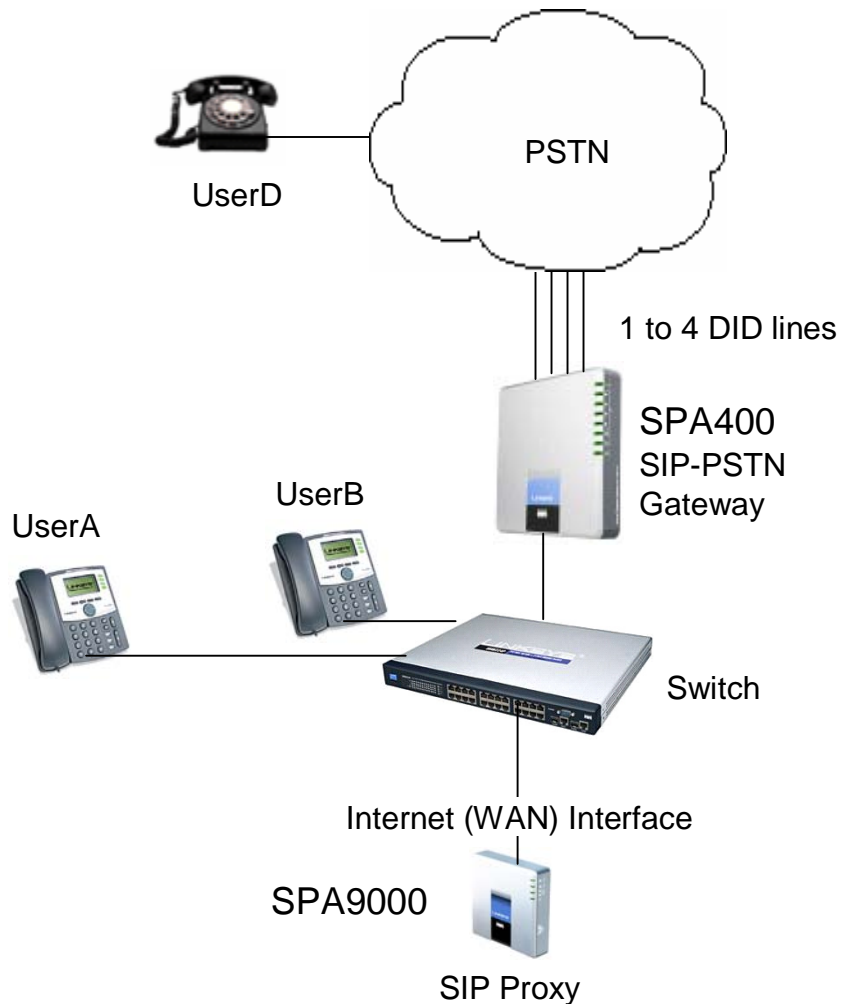

The SPA400 then converts the SIP and RTP packets it receives from UserA and the signals it receives from the PSTN switch.

SPA9000 Architecture

This section describes the basic architecture, function, and configuration options for the SPA9000.

Figure 4 SPA9000 Architecture

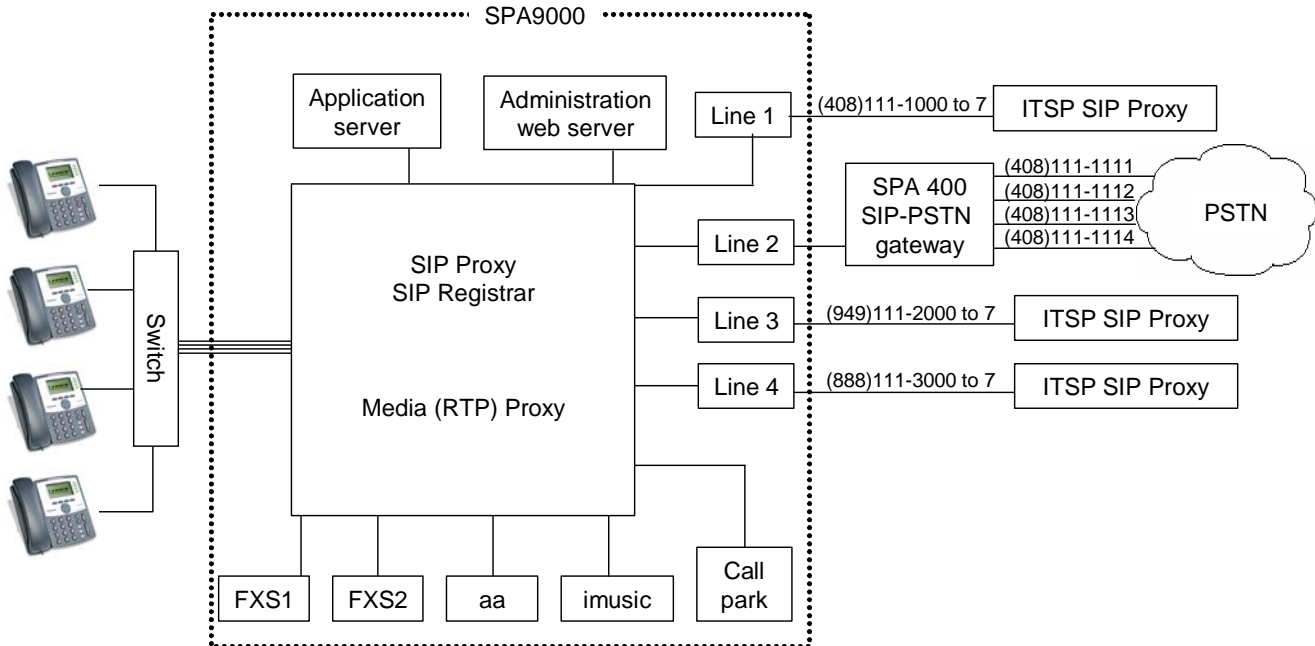

As shown, the SPA9000 provides four logical line interfaces, referred to as Line 1, 2, 3, and 4. Each line can be configured with the same or a different ITSP. Each SPA400 also occupies one line interface. The SPA9000 has five internal clients that register implicitly with the internal SIP proxy:

- FXS1 (fxs1)
- FXS2 (fxs2)
- Call Park (callpark)
- Auto-Attendant (aa)
- Internal Music Server (imusic)

FXS1 and FXS2 correspond to the two physical FXS ports. The FXS ports can only register with the local SIP proxy. The Call Park is used to maintain calls that are parked, and AA is a scriptable auto-attendant application.

Architectural Component	Function
SIP proxy and Registrar server	Accepts registration from client stations and proxies SIP messages.
Media proxy server	Proxies RTP packets between client stations and proxies SIP messages.
Configuration server	Serves configuration files to client stations and auto configures un-provisioned client stations.
Application server	Supports advanced features such as call park/pickup, directory, directed call pickup and group paging, hunt groups, and shared line appearances.
Internal music source	Streams audio files to client stations (both on-net and off-net). The FXS1 and FXS2 can optionally be connected to an external music source to act as a streaming audio server (SAS). When working in this mode, each FXS port can handle up to 10 concurrent calls.
Administration web server	Allows configuration and monitoring of the SPA9000.
ATA with 2 FXS ports	Each FXS port can be connected to analog phones, fax machine, or an external music source. Each port can support up to two calls simultaneously. The FXS ports can only register to the internal proxy server.
Call park	The call park is used to maintain calls that are parked and can handle up to 10 calls simultaneously
Auto-Attendant	AA is a scriptable auto-attendant application that can handle up to 10 calls simultaneously

SIP-NAT Interoperation

If the SPA9000 is behind the NAT device, the private IP address of the SPA9000 is not usable for communications with the SIP entities outside the private network.



NOTE If the ITSP offers an outbound NAT-Aware proxy, this discovers the public IP address from the remote endpoint and eliminates the need to modify the SIP message from the UAC.

The SPA9000 system must substitute the private IP address information with the proper external IP address/port in the mapping chosen by the underlying NAT to communicate with a particular public peer address/port. For this, the SPA9000 system needs to perform the following tasks:

- Discover the NAT mappings used to communicate with the peer.

This can be done with the help of an external device, such as a STUN server. A STUN server responds to a special NAT-Mapping-Discovery request by sending back a message to the source IP address/port of the request, where the message contains the source IP address/port of the original request. The SPA9000 system can send this request when it first attempts to communicate with a SIP entity over the Internet. It then stores the mapping discovery results returned by the server.

- Communicate the NAT mapping information to the external SIP entities.

If the entity is a SIP Registrar, the information should be carried in the Contact header that overwrites the private address/port information. If the entity is another SIP UA when establishing a call, the information should be carried in the Contact header as well as in the SDP embedded in SIP message bodies. The VIA header in outbound SIP requests might also need to be substituted with the public address if the UAS relies on it to route back responses.

- Extend the discovered NAT mappings by sending keep-alive packets.

Because the mapping is alive only for a short period, the SPA9000 system continues to send periodic keep-alive packets through the mapping to extend its validity as necessary.

Advanced Call Control and Routing

- “Configuring Vertical (Supplementary) Service Codes,” on page 173
- “Managing the Outbound Call Routing Groups,” on page 175
- “Configuring Outbound Call Codec Selection Codes,” on page 177

Configuring Vertical (Supplementary) Service Codes

Users can enter vertical (supplementary) service codes, also known as star (*) codes, to activate special calling features, such as *69 for call return. The SPA9000 Voice System is pre-configured with default star codes, but you can customize them for your site. The codes are automatically appended to the dial plan.

-
- STEP 1** Connect to the SPA9000 administration web server, and choose Admin access with Advanced settings. (See “[Connecting to the SPA9000 Administration Web Server](#),” on page 27).
- STEP 2** Click **Voice tab > Regional**.
- STEP 3** Scroll down to the *Vertical Service Activation Codes* area or the *Vertical Service Announcement Codes* section.

SPA9000 Voice > Regional: Vertical Service Activation Codes, Announcement Codes

Vertical Service Activation Codes	
Call Return Code:	*69
Blind Transfer Code:	*98
Call Back Deact Code:	*86
Cfwd All Act Code:	*72
Cfwd Busy Act Code:	*90
Cfwd No Ans Act Code:	*92
Cfwd Last Act Code:	*63
Block Last Act Code:	*60
Accept Last Act Code:	*64
CW Act Code:	*56
CW Per Call Act Code:	*71
Block CID Act Code:	*67
Block CID Per Call Act Code:	*81
Block ANC Act Code:	*77
DND Act Code:	*78
CID Act Code:	*65
CWCID Act Code:	*25
Dist Ring Act Code:	*26
Speed Dial Act Code:	*74
Secure No Call Act Code:	*17
Secure One Call Deact Code:	*19
Attn-Xfer Act Code:	
FAX Line Toggle Code:	#99
Referral Services Codes:	
Feature Dial Services Codes:	
Vertical Service Announcement Codes	
Service Annc Base Number:	
Service Annc Extension Codes:	

STEP 4 Edit the codes, as needed.

STEP 5 If desired, enter referral services and feature call services codes. For more information, see [Appendix B, "SPA9000 Field Reference," "Regional page" section on page 224.](#)



NOTE The * codes should not conflict with any of the other vertical service codes internally processed by the SPA9000. You can empty the corresponding *code that you do not want to SPA9000 to process.

STEP 6 Click **Submit All Changes**. For more information about each field, see ["Vertical Service Activation Codes section," on page 231.](#)

Managing the Outbound Call Routing Groups

Every station belongs to an outbound call routing group. You can leave all stations in the default group, or you can assign selected stations to groups for the purpose of routing their outbound calls to preferred lines.

USE CASE EXAMPLE: A company has three sales teams (New York, Los Angeles, and London) that work in an office in New York City. Calls from the New York sales team need to go out through the local PSTN lines. Calls from the Los Angeles team need to go out through an ITSP account with a Los Angeles DID number. Likewise, calls from the London sales team need to go out through an ITSP account with a London DID number. During peak call periods, if a preferred line is unavailable, calls can be routed through the general use ITSP account.

SOLUTION: The administrator creates three call routing groups and assigns client stations to them. For each group, the administrator also defines the preferred line interfaces, in order.

Call Routing Group Membership

Every station belongs to one or more of the following call routing groups:

- **Default Group:** The Default Group includes any station that is not assigned to another group.

USE CASE EXAMPLE: Non-sales personnel remain in this group.

- **Group 1 -4:** Groups 1-4 include the stations that are identified in the *Group 1 User ID...* *Group 4 User ID* fields. If the user ID matches more than one group, then the smallest group number is assumed. You can add a station to a group by entering the user ID, or you can add a range of stations by entering numbers and wildcard characters.

USE CASE EXAMPLE: The administrator enters the station user IDs for each group in the following fields:

- **Group 1 User ID:** 11?
This group includes stations 110 through 119, which are used by the New York team.
- **Group 2 User ID:** 101, 102, 103
This group includes stations 101, 102, and 103, which are used by the Los Angeles team.
- **Group 3 User ID:** 203, 204, 209
This group includes stations 203, 204, and 209, which are used by the London team.

Call Routing Group Line Preference

After you create a group, you must enter a list of lines, in the preferred order. When a group member places a call, the SPA9000 chooses the first line in the list. If it is unavailable, the SPA9000 chooses the next line, and so on, until an available line is found. To enter the lines, type the line numbers in the desired order, separated by commas.



NOTE The field cannot be left blank.

USE CASE EXAMPLE: The administrator enters the line preferences for each group in the following fields:

- **Group 1 Line:** 2 , 1
Outbound calls from Group 1 (New York) go out through Line 2 (SPA400 connected to PSTN lines). If that line interface is not available, calls can go out through Line 1 (general use ITSP account).
- **Group 2 Line:** 3 , 1
Outbound calls from Group 2 (Los Angeles) go out through Line 3 (ITSP account with a Los Angeles DID number). If that line interface is not available, calls can go out through Line 1 (general use ITSP account).
- **Group 3 Line:** 4 , 1
Outbound calls from Group 3 (London) go out through Line 4 (ITSP account with a London DID number). If that line interface is not available, calls can go out through Line 1 (general use ITSP account).

Configuring an Outbound Call Routing Group

Follow this procedure to configure an outbound call routing group.

- STEP 1** Connect to the SPA9000 administration web server, and choose Admin access with Advanced settings. (See [“Connecting to the SPA9000 Administration Web Server,”](#) on page 27).
- STEP 2** Click **Voice tab > SIP**.
- STEP 3** Scroll down to the *PBX Parameters* section.
- STEP 4** In the *Group 1 User ID* field, or other desired Group User ID field, enter the user IDs for the stations that you want to include. For more information, see [“Call Routing Group Membership,”](#) on page 175.

- STEP 5** In the *Group 1 Line* field, or other desired Group Line field, enter the line interfaces in the order of preference. For more information, see “[Call Routing Group Line Preference](#),” on page 176.



NOTE As you make your entries, read the field labels to distinguish between the fields for *Group 1 User ID ... Group 4 User ID* and *Group 1 Line ... Group 4 Line*.

- STEP 6** Click **Submit All Changes**.
- STEP 7** To verify your progress, place a call to a phone that has caller ID, and confirm that the expected number appears.

Configuring Outbound Call Codec Selection Codes

A user can enter a code selection code before dialing a number, to choose the preferred codec for the associated call. The SPA9000 Voice System is pre-configured with default codec selection codes, but you can customize them for your site. The codes are automatically appended to the dial plan.

To select a specific codec per call, the phone user enters the code before entering the telephone number.

- STEP 1** Connect to the SPA9000 administration web server, and choose Admin access with Advanced settings. (See “[Connecting to the SPA9000 Administration Web Server](#),” on page 27).
- STEP 2** Click **Voice tab > Regional**.
- STEP 3** Scroll down to the *Outbound Call Codec Selection Codes* section.

SPA9000 Voice > Regional: Outbound Call Codec Selection Codes

Outbound Call Codec Selection Codes			
Prefer G711u Code:	*017110	Force G711u Code:	*027110
Prefer G711a Code:	*017111	Force G711a Code:	*027111
Prefer G723 Code:	*01723	Force G723 Code:	*02723
Prefer G726r16 Code:	*0172616	Force G726r16 Code:	*0272616
Prefer G726r24 Code:	*0172624	Force G726r24 Code:	*0272624
Prefer G726r32 Code:	*0172632	Force G726r32 Code:	*0272632
Prefer G726r40 Code:	*0172640	Force G726r40 Code:	*0272640
Prefer G729a Code:	*01729	Force G729a Code:	*02729

STEP 4 Edit the codes, as needed.

STEP 5 Click **Submit All Changes**.

Advanced Topics for SPA400 Voice Mail Service

On the SPA9000, accessing a voicemail server to check or deposit voicemail is similar to calling an external number, or being call forwarded to an external number. Each line interface can use a different voicemail server.

There are three groups of voicemail operations:

- Depositing voicemail
- Managing voicemail from a client station or from an external number
- Subscription to voicemail notification and receiving voicemail notification

SPA9000 assumes that a voicemail account can include more than one mailbox ID (MBID). The voicemail account is defined with a user-ID, which can be the same as the line interface user-ID.

Three parameters must be configured on the SPA9000 for each line to support these operations: <Mailbox Deposit URL>, <Mailbox Manager URL>, and <Mailbox Subscribe URL>.



NOTE The mailbox ID should be set to the extension number.

Voicemail service may be offered by a service provider different from the ITSP. For example, you can configure Line 1, 2, and 3 with accounts on an ITSP, but configure Line 4 an account with a different Internet voicemail service provider (IVMSP). The SPA9000 can be configured to bridge calls between the ITSP and the IVMSP when necessary (when depositing or checking voicemail by an external caller) using the <VMSP Bridge> parameter on each line interface.

How Voicemail Works

When a user checks voicemail from a client station, the SPA9000 sends an INVITE on its behalf to the configured <Mailbox Manage URL>. For example:

```
INVITE sip:mailbox-manage-url SIP/2.0
Via: SIP/2.0/UDP 192.168.2.205:5060;branch=z9hG4bK-
171eb6b5
From:
<sip:37683102@sip.myitsp.com>;tag=300704dd2590d20bo2;ref=5
031;mbid=53371
To: <sip:mailbox-manage-url>
Call-ID: 58a2b2c5-66e2bd43@192.168.2.205
CSeq: 101 INVITE
Max-Forwards: 70
Contact: <sip:37683102@192.168.2.205:5060>
```

Here the client station is at extension 5031 and the mailbox ID is 53371. The voicemail server should then prompt the caller to enter a PIN and access the voicemail features for the given mailbox.

A user should also be able to call an external number explicitly from anywhere to retrieve voice mail messages. When the voicemail server receives such a call, it should prompt the caller to enter the mailbox ID and then the PIN number. If the user-ID of the voicemail account cannot be uniquely identified from the mailbox ID or from the called number, the server must first prompt the user to enter the user-ID before proceeding.



NOTE If an EXT-To-DID mapping exists for the calling extension on the line interface, the user-ID and display name fields of the FROM header are replaced by the mapped DID number and the display name assigned to the phone, respectively. In this case, a DIVERSION header similar to the REFERRED-BY header is also included.

Checking Voicemail from an External Number

The Internet voicemail service provider (IVMSP) may have an external number for their subscribers to call to check/manage their mailboxes. If this is not available, you may do one of the following:

- Assign a DID number (from the ITSP).
- Create a virtual extension for this purpose.

For method (a), specify a rule in the <Contact List> for the dedicated DID number. For the DID number 18005551000, this would look like the following example:

```
... | ... | 18005551000:vmm3 | ...
```

The syntax vmm<n> tells the SPA9000 to forward calls dialed to 18005551000 to the voicemail management URL on Line <n>. Because no particular mailbox is specified in this example, the caller is prompted to enter the voicemail number after the voicemail server answers. You may also specify a particular mailbox ID with this syntax (for example, vm31234).

Method (b) is used in conjunction with the Auto-Attendant. For example, you can define a single-digit extension 7 to map to the voicemail management URL on Line 4, by adding a rule to <AA Dial Plan 1> or <AA Dial Plan 2> depending on which one you are using. The rule would look like the following:

```
<7:vmm4>
```

Again, you may also specify a particular mailbox in this syntax. For information about configuring the Auto-Attendant, refer to [Chapter 7, “Configuring the Auto Attendant.”](#)

Depositing Voicemail

An external caller can be triggered to deposit voicemail into a mailbox by sending it a REFER request during a call with <Mailbox Deposit URL> indicated in the REFER-TO header and the mailbox ID in the REFERRED-BY header. The caller device then sends INVITE to the <Mailbox Deposit URL> as shown in the example below:

```
INVITE sip:mailbox-deposit-url SIP/2.0
Via: SIP/2.0/UDP 24.35.36.111;branch=z9hG4bK-29752ae9
From: "External Caller" <sip:9991234@sip.myitsp.com>;tag=b99e21414928473o2
To: <sip:mailbox-deposit-url>
Call-ID: 69e9e3d9-cfcbe2bb@24.35.36.111
CSeq: 101 INVITE
Contact: <sip:9991234@24.35.36.111>
Referred-By: <sip:37683101@sip.myitsp.com>;ref=5041;mbid=7675
```

In the last example, the caller is directed to deposit voicemail in the mailbox ID 7675 on the voicemail account 37683101. It further indicates that the directing station is at the internal extension 5041. Note that it is assumed that the caller device (or the ITSP) is faithfully relayed over the REFERRED-BY header.



NOTE The mailbox ID must be set to the extension number.

The INVITE sent for an internal caller to deposit voicemail is similar, except that the FROM header also includes a reference parameter, as shown in the following example:

```
INVITE sip:mailbox-deposit-url SIP/2.0
Via: SIP/2.0/UDP 172.12.244.56;branch=z9hG4bK-29752ae9
From: Line 1 <sip:37683101@sip.myitsp.com>;tag=b99e21414928473o2;ref=5031
To: <sip:mailbox-deposit-url>
Call-ID: 69e9e3d9-cfcbe2bb@172.12.244.56
CSeq: 101 INVITE
Max-Forwards: 70
Contact: <sip:37683101@172.12.244.56>
Referred-By: <sip:37683101@sip.myitsp.com>;mbid=7675
```

In the above example, the station wanting to deposit voicemail is at extension 5031; the mailbox ID is 7675 on the account 37683101 (for the station at extension 5041). Note that the referrer is the same as the caller in the last INVITE. In other words, this INVITE is self-triggered by the SPA9000.

If an EXT-To-DID mapping exists for the calling extension on the line interface, the user-ID and display name fields of the FROM header is replaced by, respectively, the mapped DID number and the display name assigned to the phone. Furthermore, if an EXT-To-DID mapping exists for the called phone, the user-ID field of the REFERRED-BY header is also replaced by the mapped DID number for the called extension.



NOTE For information about how to add an EXT-to-DID mapping, see the <Contact List> parameter in [Appendix B, “SPA9000 Field Reference.”](#)

Subscribing to Voicemail Notification

The SPA9000 sends a one-time SUBSCRIBE for the message-summary event package for each line with a valid <Mailbox Subscribe URL>. The SUBSCRIBE implies subscription for the status of all the mailboxes associated with the voicemail account used-ID; it does not include any mailbox ID in the request. Following is an example:

```
SUBSCRIBE sip:mailbox-subscribe-url SIP/2.0
Via: SIP/2.0/UDP 172.16.22.23:5062;branch=z9hG4bK-44f9d0f0
From: Line 3 <sip:14089991003@sip.myitisp.com>;tag=ac6013983cce7526
To: <sip:mailbox-subscribe-url>
Call-ID: ace86200-bbe839de@172.16.22.23
CSeq: 63017
SUBSCRIBE Max-Forwards: 70
Contact: <sip:14089991003@172.16.22.23:5062>
Expires: 30
Event: message-summary
User-Agent: Sipura/SPA9000-3.2.2
Content-Length: 0
```

The voicemail server is expected to send a NOTIFY immediately upon receiving this SUBSCRIBE message for each mailbox on this account. The Request-URI of the NOTIFY should reference the CONTACT header of the corresponding SUBSCRIBE, but the user-ID in the To header should be the mailbox ID. The following example shows a NOTIFY for the mailbox ID 5031 on the account 14089991003:

```
NOTIFY sip:14089991003@172.16.22.23:5062 SIP/2.0
Via: SIP/2.0/UDP 178.178.221.230;branch=z9hG4bK-44f9d0f0
From: <sip:voicemail@sip.myitisp.com>;tag=ab789
To: <sip:5031@172.16.22.23:5062>;tag=ac6013983cce7526
Call-ID: ace86200-bbe839de@178.178.221.230
CSeq: 537
NOTIFY Expires: 30
Event: message-summary User-Agent: ITSP/Voicemail-Server
Content-Length: 0
Messages-Waiting: yes
Voice-Message: 2/8 (0/2)
```



NOTE Note that SPA9000 does not require the NOTIFY to be sent within the same subscription dialog. That is, it accepts the NOTIFY even without a TO-tag or a matching Call-ID as the original SUBSCRIBE.

Remote Provisioning Features

The SPA9000 provides for secure provisioning and remote upgrade. Provisioning is achieved through configuration profiles that are transferred to the device via TFTP, HTTP, or HTTPS.

Using Configuration Profiles

The SPA9000 accepts configuration profiles in XML format, or alternatively in a proprietary binary format, which is generated by a profile compiler tool available from Linksys. The SPA9000 supports up to 256-bit symmetric key encryption of profiles. For the initial transfer of the profile encryption key (initial provisioning stage), the SPA9000 can receive a profile from an encrypted channel (HTTPS with client authentication), or it can resync to a binary profile generated by the Linksys-supplied profile compiler. In the latter case, the profile compiler can encrypt the profile specifically for the target SPA9000, without requiring an explicit key exchange.

The XML file consists of a series of elements (one per configuration parameter), encapsulated within the element tags `<flat-profile> ... </flat-profile>`. The encapsulated elements specify values for individual parameters.

Refer to the following example of a valid XML profile:

```
<flat-profile>
<Admin_Passwd>some secret</Admin_Passwd>
<Upgrade_Enable>Yes</Upgrade_Enable>
</flat-profile>
```

Binary format profiles contain SPA9000 parameter values and user access permissions for the parameters. By convention, the profile uses the extension `.cfg` (for example, `spa2000.cfg`). The Linksys Profile Compiler (SPC) tool compiles a plain-text file containing parameter-value pairs into a properly formatted and encrypted `.cfg` file. The SPC tool is available from Linksys for the Win32 environment and Linux-i386-elf environment. Requests for SPC tools compiled on other platforms are evaluated on a case-by-case basis. Please contact your Linksys sales representative for further information about obtaining the SPC tool.

The syntax of the plain-text file accepted by the profile compiler is a series of parameter-value pairs, with the value in double quotes. Each parameter-value pair is followed by a semicolon. Here is an example of a valid text source profile for input to the SPC tool:

```
Admin_Passwd "some secret";
Upgrade_Enable "Yes";
```

Refer to the *SPA9000 Voice System SPA Provisioning Guide* for further details.

The names of parameters in XML profiles can generally be inferred from the SPA9000 configuration Web pages, by substituting underscores (_) for spaces and other control characters. Further, to distinguish between Lines 1, 2, 3, and 4, corresponding parameter names are augmented by the strings `_1_`, `_2_`, `_3_`, and `_4_`. For example, Line 1 Proxy is named `Proxy_1_` in XML profiles.

Parameters in the case of source text files for the SPC tool are similarly named, except that to differentiate Line 1, 2, 3, and 4, the appended strings ([1], [2], [3], or [4]) are used. For example, the Line 1 Proxy is named `Proxy[1]` in source text profiles for input to the SPC.

Client Auto-Configuration

An unprovisioned client station in the factory default state can be automatically provisioned by the SPA9000 by following the flow chart shown in [Figure 5 “Unprovisioned Client Station Acquiring a Configuration Profile” on page 185](#).

When the SPA9000 receives a request for `/cfg/init_$(MA).xml`, it automatically assigns the next available user ID (extension number) to this client station. The next user ID to be assigned to a new client station is configured using The `<Next Auto User ID>` parameter and is automatically incremented each time a new number is assigned. Before assigning a new user ID, the SPA9000 also checks whether there is any registered client station using that ID and keeps increasing the ID until an unused value is found.

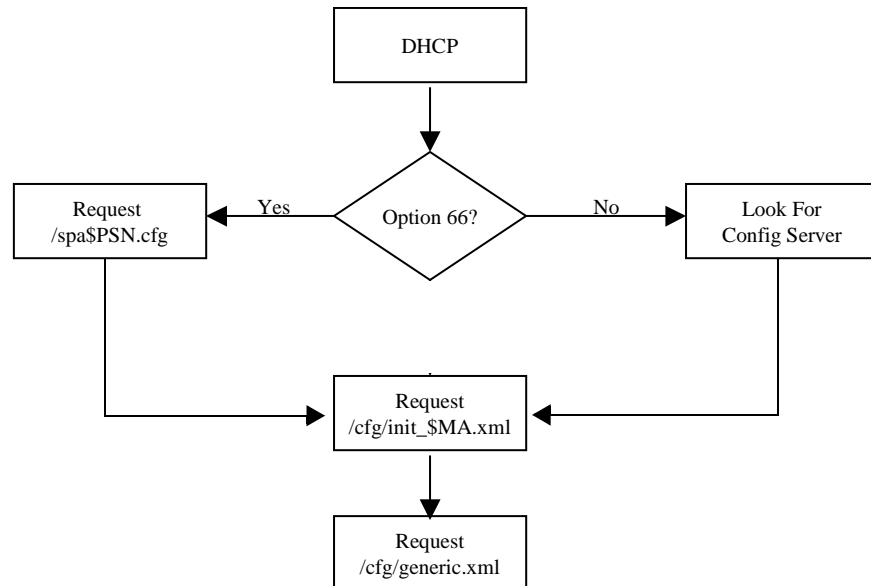
Figure 5 Unprovisioned Client Station Acquiring a Configuration Profile

To add a new IP phone to the SPA9000, connect the IP phone to the QoS switch to which the SPA9000 is connected and power on the unit.

To add a previously-used IP phone to the SPA9000, perform the following steps:

1. Upgrade the IP phone with SPA9000-compatible firmware.
2. Factory reset the unit.
3. Power cycle the unit.
4. Connect the unit to the switch.

The SPA9000 provisions only the necessary parameters to the client stations. It assumes the rest of the parameters have appropriate values, which are either the default values or manually configured values. For example, the SPA9000 provisions only Extension 1 on the client stations. Access the administration web server using the Administrator account to manually configure other extensions on specific client stations.

Manual Client Configuration

The client stations can also be manually configured with the contents of the profile served by the SPA9000.

The following XML file is served by the SPA9000 when a client station requests /spa\$PSN.cfg

```
<flat-profile>
<Resync_Periodic>1</Resync_Periodic>
<Profile_Rule>tftp://spa-9000-ip-address:69/cfg/
init_$MA.xml</Profile_Rule>
</flat-profile>
```

The following XML file is served by the SPA9000 when client station requests /cfg/init_\$MA.xml:

```
<flat-profile>
<User_ID_1_>next-available-user-id</User_ID_1_>
<Extension_1_>1</Extension_1_>
<Short_Name_1_>next-available-user-id</Short_Name_1_>
<Extension_2_>1</Extension_2_>
<Short_Name_2_>next-available-user-id</Short_Name_2_>
<Extension_3_>1</Extension_3_>
<Short_Name_3_>next-available-user-id</Short_Name_3_>
<Extension_4_>1</Extension_4_>
<Short_Name_4_>next-available-user-id</Short_Name_4_>
<Station_Name>client-station-mac-address</Station Name>
<Resync_Periodic>1</Resync_Periodic>
<Resync_Error_Retry_Delay>10</Resync_Error_Retry_Delay>
<Profile_Rule>tftp://spa-9000-ip-address:69/cfg/
generic.xml</Profile_Rule>
<Linksys_Key_System>1</Linksys_Key_System>
</flat-profile>
```

The following XML file is served by the SPA9000 when a client station requests /cfg/generic.xml:

```
<flat-profile>
<Resync_Periodic>0</Resync_Periodic>
<Resync_Error_Retry_Delay>3600</Resync_Error_Retry_Delay>
<Admin_Passwd>spa-9000-admin-passwd</Admin_Passwd>
<Password_1_>phone-ext-password</Password_1_>
<Proxy_1_>spa-9000-ip-address:proxy-listen-port</Proxy_1_>
<Voice_Mail_Server_1_>spa-9000-ip-address:proxy-listen-port
</Voice_Mail_Server_1_>
<Voice_Mail_Number>vmm</Voice_Mail_Number>
<Cfwd_Busy_Dest>vm</Cfwd_Busy_Dest>
<Cfwd_No_Ans_Dest>vm</Cfwd_No_Ans_Dest>
<Multicast_Address>spa-9000-multicast-address</
Multicast_Address>
<Upgrade_Rule>phone-upgrade-rule</Upgrade_Rule>
<Dial_Plan>phone-dial-plan</Dial_Plan>
<Linksys_Key_System>1</Linksys_Key_System>
<Remote_Party_ID_1_>1</Remote_Party_ID_1_>
<Time_Zone>time-zone</Time_Zone>
<Daylight_Saving_Time_Rule>daylight-saving-time</
Daylight_Saving_Time_Rule>
</flat-profile>
```

The following table lists the variables used in these XML files.

Table 1 Variables Used in XML Configuration Files

Variable	Description
spa-9000-ip-address	IP address of the SPA9000 SIP Proxy.
proxy-listen-port	Port at which the SPA9000 SIP Proxy is listening. This value is configured in <Proxy Listen Port>.
client-station-mac-address	This is the MAC address of the client station who is requesting the profile /cfg/init_\$(MA).xml (in other words, the \$(MA) portion of the requested filename).
next-available-user-id	The current value of <Next Auto User ID>.
Phone-upgrade-rule	Upgrade rule to be used by the client stations. This value is configured in <Phone Upgrade Rule>.
Phone-dial-plan	Dial plan to be used by the client stations. This value is configured in <Phone Dial Plan>.
time-zone	<Time Zone> value that is configured on the SPA9000.
daylight-saving-time	<Daylight Saving Time Rule> value that is configured on the SPA9000.
phone-ext-password	<Phone Ext Password> value configured on the SPA9000.
spa-9000-admin-passwd	<Admin Passwd> value configured on the SPA9000.
spa-9000-multicast-address	<Multicast Address> value configured on the SPA9000.

Client stations download spa\$(PSN).cfg and init_\$(MA).xml only once for initial configuration. However, they download generic.xml on every reboot. Therefore, parameters manually configured on the client station that overlap with the contents of generic.xml are overwritten with the SPA9000-supplied values. The list of parameters included in generic.xml are thus purposely kept to a very small set.

Client Registration

All client stations served by the SPA9000 must register to the SPA9000, which does not allow a station to make calls unless it is registered. If the client station is configured with Station Name, it should include a P-STATION-NAME header in the REGISTER request. Following is an example where User-A has been assigned a primary extension of 5031.

```
REGISTER sip:192.168.0.1:6060 SIP/2.0
Via: SIP/2.0/UDP 192.168.0.4:5060;branch=z9hG4bK-8865c41e
From: "User-A"
<sip:5031@192.168.0.1:6060>;tag=a76a3e1dfc6045cdo0
To: "User-A" <sip:5031@192.168.0.1:6060>
Call-ID: 52dab65d-21d02a8d@192.168.0.4
CSeq: 1 REGISTER
Max-Forwards: 70
Contact: "User-A" <sip:5031@192.168.0.4:5060>;expires=3600
User-Agent: Sipura/SPA841-3.1.4(a0714sec)
P-Station-Name: User-A
Content-Length: 0
Allow: ACK, BYE, CANCEL, INFO, INVITE, NOTIFY, OPTIONS,
REFER, SUBSCRIBE
Allow-Events: dialog
```

In this example, User-A shares a line appearance with User-B, whose primary extension is 5041. Extension 2 on the User-A station must then be set up the same way as Extension 1 (User-A primary extension), but with the <Shared User ID> parameter set to 5041. The User-A station then performs a third-party registration for Extension 2, as shown below. Note that the TO header <user-id> parameter is the User-B primary extension.

```
REGISTER sip:192.168.0.1:6060 SIP/2.0
Via: SIP/2.0/UDP 192.168.0.4:5061;branch=z9hG4bK-25c8108c
From: "User-A"
<sip:5031@192.168.0.1:6060>;tag=3c43d094a9424bo1
To: "User-A" <sip:5041@192.168.0.1:6060>
Call-ID: 26c913d8-485f71e3@192.168.0.4
CSeq: 1 REGISTER
Max-Forwards: 70
Contact: "User-A" <sip:5041@192.168.0.4:5061>;expires=3600
User-Agent: Sipura/SPA841-3.1.4(a0714sec)
P-Station-Name: 000e08daf417
Content-Length: 0
Allow: ACK, BYE, CANCEL, INFO, INVITE, NOTIFY, OPTIONS,
REFER, SUBSCRIBE
Allow-Events: dialog
```

The 200 reply sent by the SPA9000 to the client station REGISTER request includes a DATE header that the client station can use to synchronize with its local real-time clock. The time served in the DATE header is the local time (as opposed to GMT). There is thus no need to configure an NTP server or a time zone on the client stations. This assumes that the SPA9000 can maintain the real-time clock based on an NTP server or a DATE header supplied by the ITSP. Following is an example of a 200 response to REGISTER (note that there is no weekday in the DATE header):

```
SIP/2.0 200 OK
To: "User-A" <sip:5031@192.168.0.1:6060>;tag=41a7-0
From: "User-A" <sip:5031@192.168.0.1:6060>;tag=8d0bd416dc8a7ec2o0
Call-ID: 9a12cb26-8d9172f2@192.168.0.4
CSeq: 1 REGISTER
Via: SIP/2.0/UDP 192.168.0.4:5060;branch=z9hG4bK-e62fe987
Contact: sip:5031@192.168.0.4:5060;expires=3600
Content-Length: 0
Date: Mon, 18 Jul 2005 14:39:40 PST
```

Using the Upgrade URL

Remote firmware upgrade is achieved via TFTP or HTTP (firmware upgrades using HTTPS are not supported). Remote upgrades are controlled by configuring the desired firmware image URL into the SPA9000 via a remote profile resync.



NOTE To use this feature, the *Upgrade Enable* field on the *Voice > Provisioning* page must be set to **Yes**.

SYNTAX:

```
http://spa-ip-addr/admin/upgrade?[protocol://][server-name[:port]][/firmware-pathname]
```

EXAMPLE: `http://192.168.2.217/admin/upgrade?tftp://192.168.2.251/spaconf.cfg`

Both HTTP and TFTP are supported for the upgrade operation.

- If no protocol is specified, TFTP is assumed. If **no server-name** is specified, the host that requests the URL is used as *server-name*.
- If no port specified, the default port of the protocol is used. (69 for TFTP or 80 for HTTP)
- The *firmware-pathname* is typically the file name of the binary located in a directory on the TFTP or HTTP server. If no *firmware-pathname* is specified, /

spa.bin is assumed, as in the following example: `http://192.168.2.217/admin/upgrade?tftp://192.168.2.251/spa.bin`

Using the Resync URL

The SPA9000 can be configured to automatically resynchronize its internal configuration state to a remote profile periodically and on power up. The automatic resyncs are controlled by configuring the desired profile URL into the device.



NOTE The SPA resynchronizes only when it is idle.

SYNTAX:

```
http://spa-ip-addr/admin/resync?[[protocol://][server-name[:port]]/profile-pathname]
```

EXAMPLE: `http://192.168.2.217/admin/resync?tftp://192.168.2.251/spaconf.cfg`

- If no parameter follows **/resync?**, the Profile Rule setting from the Provisioning page is used.
- If no protocol is specified, TFTP is assumed. If no server-name is specified, the host that requests the URL is used as *server-name*.
- If no port is specified, the default port is used (69 for TFTP, 80 for HTTP, and 443 for HTTPS).
- The profile-path is the path to the new profile with which to resync.

Using the Reboot URL

You can use the Reboot URL to reboot the SPA9000.



NOTE The SPA9000 reboots only when it is idle.

SYNTAX: `http://spa-ip-addr/admin/reboot`

EXAMPLE: `http://192.168.2.217/admin/reboot`

SPA9000 Field Reference

This appendix describes the fields on each page of the SPA9000 administration web server.

After you connect to the SPA9000, you can use the following tabs to open the modules of the application:

- “Router Tab,” on page 191
- “Voice tab,” on page 197

Router Tab

After you click the *Router* tab, you can choose the following pages:

- “Status page,” on page 191
- “Wan Setup page,” on page 193
- “Lan Setup page and Application page,” on page 196

Router tab >

Status page

You can use the *Status* page to view information about the SPA9000. The *Status* page has the following sections:

- “Product Information section,” on page 192
- “System Status section,” on page 192

Router tab > Status page >

Product Information section

Product Name	Model number of the SPA9000
Serial Number	Serial number of the SPA9000
Software Version	Version number of the SPA9000 software
Hardware Version	Version number of the SPA9000 hardware
MAC Address	MAC address of the SPA9000
Client Certificate	Status of the client certificate, which authenticates the SPA9000 for use in the ITSP network
Customization	For an remote configuration (RC) unit, this field indicates whether the unit has been customized or not. Pending indicates a new RC unit that is ready for provisioning. If the unit has already retrieved its customized profile, this field displays the name of the company that provisioned the unit.
Licenses	When populated with the value K0, indicates that the SPA9000 is licensed for up to 16 users; if this field is blank, install firmware version 5.2.5 or higher.

Router tab > Status page >

System Status section

Current Time	Current date and time of the system; for example, 10/3/2003 16:43:00
Elapsed Time	Total time elapsed since the last reboot of the system; for example, 25 days and 18:12:36
Wan Connection Type	The connection type: DHCP or Static IP
Current IP	The current IP address assigned to the SPA9000
Host Name	The current host name assigned to the SPA9000
Domain	The network domain name of the SPA9000
Current Netmask	The network mask assigned to the SPA9000
Current Gateway	The default router assigned to the SPA9000
Primary DNS	The primary DNS server assigned to the SPA9000
Secondary DNS	The secondary DNS server assigned to the SPA9000
LAN IP Address	The LAN IP address of the SPA9000. SPA9000 NOTE Do not deploy the SPA9000 as a router.

Current Time	Current date and time of the system; for example, 10/3/2003 16:43:00
Broadcast Pkts Sent	Total number of broadcast packets sent
Broadcast Bytes Sent	Total number of broadcast bytes sent
Broadcast Pkts Recv	Total number of broadcast bytes received
Broadcast Bytes Recv	Total number of broadcast bytes received and processed
Broadcast Pkts Dropped	Total number of broadcast packets received but not processed
Broadcast Bytes Dropped	Total number of broadcast bytes received but not processed

Router tab >

Wan Setup page

You can use the *Wan Setup* page to enter the WAN connection settings. This page includes the following sections:

- “Internet Connection Settings section,” on page 193
- “Static IP Settings section,” on page 194
- “PPPoE Settings section,” on page 194
- “Optional Settings section,” on page 194
- “MAC Clone Settings section,” on page 195
- “Remote Management section,” on page 195
- “QOS Settings section,” on page 196
- “VLAN Settings section,” on page 196

Router tab > Wan Setup page >

Internet Connection Settings section

Connection Type	IP address assignment scheme, static or DHCP.
-----------------	---

Router tab > Wan Setup page >

Static IP Settings section

Static IP	Static IP address of SPA9000, which takes effect if DHCP is disabled. Default: 0.0.0.0
NetMask	The NetMask used by SPA9000 when DHCP is disabled. Default: 255.255.255.0
Gateway	The default gateway used by SPA9000 when DHCP is disabled. Default: 0.0.0.0

Router tab > Wan Setup page >

PPPoE Settings section

PPPoE Login Name	The account name assigned by the ISP for connecting on a Point-to-Point Protocol over Ethernet (PPPoE) link.
PPPoE Login Password	The password assigned by the ISP for connecting on a Point-to-Point Protocol over Ethernet (PPPoE) link.
PPPoE Service Name	The service name assigned by the ISP for connecting on a Point-to-Point Protocol over Ethernet (PPPoE) link.

Router tab > Wan Setup page >

Optional Settings section

HostName	The host name of the SPA9000
Domain	The network domain of the SPA9000.
Primary DNS	The DNS server that is used by the SPA9000 NOTE When DHCP is enabled, you can enter the IP address of a DNS server in addition to DHCP-supplied DNS servers. When DHCP is disabled, enter the primary DNS server. Default: 0.0.0.0

Secondary DNS	The DNS server that is used by the SPA9000 NOTE When DHCP is enabled, you can enter the IP address of a DNS server in addition to DHCP-supplied DNS servers. When DHCP is disabled, enter the primary DNS server. Default: 0.0.0.0
DNS Server Order	The method for selecting the DNS server: Manual, Manual/DHCP, and DHCP/Manual
DNS Query Mode	The mode of DNS query: parallel or sequential NOTE With parallel DNS query mode, the SPA9000 sends the same DNS lookup request to all the DNS servers at the same time, and the first incoming reply is accepted by the SPA9000. Default: parallel
Primary NTP Server	The IP address or name of the primary NTP server
Secondary NTP Server	The IP address or name of the secondary NTP server
DHCP IP Revalidate Timer:	

Router tab > Wan Setup page >

MAC Clone Settings section

Enable MAC Clone Service	Enable if you need to assign a different MAC address to the SPA9000 via the Cloned MAC Address field.
Cloned MAC Address	The MAC address that you need the SPA9000 to assume

Router tab > Wan Setup page >

Remote Management section

Enable WAN Web Server	Allows (yes) or prevents (no) access to the administration web server from a computer that is not directly connected to the SPA9000. Default: yes
WAN Web Server Port	The port that is used for WAN access to the SPA9000 Default: 80

Router tab > Wan Setup page >

QoS Settings section

QoS Policy	The queueing discipline, set to none or token bucket filter (TBF). TBF limits the rate of transmission to not attempt to exceed the Maximum Uplink Speed.
QoS QDisc	Allow QoS Queuing. Options are None or TBF (token bucket filter). Information can be found at about TBF at: lartc.org/howto/lartc.qdisc.classless.html
Maximum Uplink Speed	Define this value to allow the token bucket filter queueing discipline to manage traffic flow to ensure high quality voice audio.

Router tab > Wan Setup page >

VLAN Settings section

Enable VLAN	Enable voice data to be tagged with the defined VLAN ID. NOTE Choose yes if your SPA9000 is connected to a switch that uses VLAN tagging.
VLAN ID	The VLAN tag for the VLAN to which the SPA9000 is assigned

Router tab >

Lan Setup page and Application page



NOTE Linksys Engineering and Quality Assurance strongly advise against using the SPA9000 as a router. For this reason, the *Lan Setup* and *Application* tabs should not be modified from the default, unused state. The SPA9000 must only be connected to a switch via the SPA9000 INTERNET RJ45 connector. Do not connect any cable to the SPA9000 ETHERNET port, or you may experience degraded audio performance.

Voice tab

After you click the Voice tab, you can use the following pages:

- “Info page,” on page 197
- “System page,” on page 200
- “SIP Page,” on page 202
- “Regional page,” on page 224
- “FXS 1/2 page,” on page 241
- “Line 1/2/3/4 page,” on page 251

Voice tab >

Info page

You can use the *Info* page to view information about the FXS devices and the line interfaces. This page includes the following sections:

- “Product Information section,” on page 192
- “System Status section,” on page 198
- “FXS 1/2 Status section,” on page 198
- “Line 1/2/3/4 Status section,” on page 199
- “Auto Attendant Prompt Status section,” on page 200
- “Internal Music Status section,” on page 200

Voice tab > Info page >

Product Information section

Product Name	The model number of the SPA9000
Serial Number	The serial number of the SPA9000
Software Version	The version number of the SPA9000 software
Hardware Version	The version number of the SPA9000 hardware
MAC Address	The MAC address of the SPA9000

Client Certificate	The status of the client certificate, which authenticates the SPA9000 for use in the ITSP network
Customization	For an remote configuration (RC) unit, this field indicates whether the unit has been customized or not. Pending indicates a new RC unit that is ready for provisioning. If the unit has already retrieved its customized profile, this field displays the name of the company that provisioned the unit.
Licenses	When populated with the value K0, indicates that the SPA9000 is licensed for up to 16 users; if this field is blank, install firmware version 5.2.5 or higher.

Voice tab > Info page >

System Status section

Current Time	The current date and time of the system; for example, 10/3/2003 16:43:00
Elapsed Time	The total time elapsed since the last reboot of the system; for example, 25 days and 18:12:36

Voice tab > Info page >

FXS 1/2 Status section

Hook State	The readiness of the device that is connected to the corresponding Phone port on the SPA9000 <ul style="list-style-type: none"> ▪ On: Ready for use ▪ Off: In use
Message Waiting	Indicates whether the station assigned to the FXS port has new voicemail waiting: Yes or No
Call Back Active	Indicates whether a call back request is in progress: Yes or No
Last Called Number	Last number called
Last Caller Number	Number of the last caller if available from caller ID, example 4085551212
Call 1/2 State	Status of the call; Ringing, Idle, or Connected
Call 1/2 Tone	Type of tone used by the call, for example Ring Back 2 for inbound call or None for outbound call
Call 1/2 Encoder	Codec used for encoding

Call 1/2 Decoder	Codec used for decoding
Call 1/2 FAX	Status of the fax pass-through mode; set to No if this line is used for voice calls
Call 1/2 Type	Direction of the call: Inbound or Outbound
Call 1/2 Remote Hold	Indicates whether or not the far end has placed the call on hold: Yes or No
Call 1/2 Callback	Indicates whether the call was triggered by a call back request
Call 1/2 Peer Name	Name of the peer, internal station name if local phone, or name acquired from caller-ID
Call 1/2 Peer Phone	Phone number of the other phone involved in the call, either the extension if a local phone, or the number acquired from caller-ID
Call 1/2 Duration	Duration of the call
Call 1/2 Packets Sent	Number of packets sent
Call 1/2 Packets Recv	Number of packets received
Call 1/2 Bytes Sent	Number of bytes sent
Call 1/2 Bytes Recv	Number of bytes received
Call 1/2 Decode Latency	Number of milliseconds for decoder latency
Call 1/2 Jitter	Number of milliseconds for receiver jitter
Call 1/2 Round Trip Delay	Number of milliseconds for delay
Call 1/2 Packets Lost	Number of packets lost
Call 1/2 Packet Error	Number of invalid packets received

Voice tab > Info page >

Line 1/2/3/4 Status section

Registration State	The status of the registration on the line interface: Registered or Not Registered
Last Registration At	Last date and time the line was registered: mm/dd/yyyy hh:mm:ss
Next Registration In	Number of seconds before the next registration renewal; example 2672s
Message Waiting	Indicates whether you have new voicemail waiting: Yes or No
Mapped SIP	Port number of the SIP port mapped by NAT

Voice tab > Info page >

Auto Attendant Prompt Status section

Field	Description
Prompt 1	The duration of the prompt in milliseconds
Prompt 2	The duration of the prompt in milliseconds
Prompt 3	The duration of the prompt in milliseconds
Prompt 4	The duration of the prompt in milliseconds
Prompt 5	The duration of the prompt in milliseconds
Prompt 6	The duration of the prompt in milliseconds
Prompt 7	The duration of the prompt in milliseconds
Prompt 8	The duration of the prompt in milliseconds
Prompt 9	The duration of the prompt in milliseconds
Prompt 10	The duration of the prompt in milliseconds
Space Remaining	Number of milliseconds available
Current AA	Auto-attendant in use; example: Daytime

Voice tab > Info page >

Internal Music Status section

Installed Music Path	The pathname for the music source used for the music-on-hold feature; example: Factory Default
----------------------	--

Voice tab >

System page

You can use the *System* page to set up restricted access domains, manage web access to the sPA9000, set the logon passwords, and manage system log settings and debugging. This page includes the following sections:

- “System Configuration section,” on page 201
- “Miscellaneous Settings section,” on page 201

Voice tab > System page >

System Configuration section

Restricted Access Domains	Define up to five IP addresses or fully qualified domain names to identify the domains in which the SPA9000 is allowed to operate.
Enable Web Admin Access	Allows (yes) or prevents (no) local access to the administration web server
Admin Passwd	Password for the administrator. Up to 39 characters are allowed for the passwords. All characters are legal. Default: no password
User Password	Password for the user. Up to 39 characters are allowed for the passwords. All characters are legal. Default: no password

Voice tab > System page >

Miscellaneous Settings section

Syslog Server	The IP address of the syslog server to which the SPA9000 sends syslog messages. Leave blank if you do not want to receive syslog messages.
Debug Server	The IP address of the debug server, which logs debug information. The level of detailed output depends on the Debug Level parameter setting.
Debug Level	The level of debug information that is generated, from 0 to 3. 0 is a minimal level of debugging information that is acceptable for most purposes. Levels 1 to 3 are typically used only by Linksys personnel. NOTE Default: 0

Voice tab >

SIP Page

You can use the *SIP* page to enter many settings that are important for the proper functioning of SIP on your SPA9000. This page includes the following sections:

- “SIP Parameters section,” on page 202
- “SIP Timer Values (sec) section,” on page 204
- “Response Status Code Handling section,” on page 206
- “RTP Parameters section,” on page 207
- “SDP Payload Types section,” on page 208
- “NAT Support Parameters section,” on page 210
- “PBX Parameters section,” on page 212
- “Internal Music Source Parameters section,” on page 216
- “Auto Attendant Parameters section,” on page 218
- “PBX Phone Parameters section,” on page 222

Voice tab > SIP page

SIP Parameters section

Max Forward	SIP Max Forward value, which can range from 1 to 255. Default: 70
Max Redirection	Number of times an invite can be redirected to avoid an infinite loop. Default: 5
Max Auth	Maximum number of times (from 0 to 255) a request may be challenged. Default: 2
SIP User Agent Name	User-Agent header used in outbound requests. If empty, the header is not included. Macro expansion of \$A to \$D corresponding to GPP_A to GPP_D allowed. Default: \$VERSION

SIP Server Name	Server header used in responses to inbound responses. Default: \$VERSION
SIP Reg User Agent Name	User-Agent name to be used in a REGISTER request. If this value is not specified, the <SIP User Agent Name> is also used for the REGISTER request. Default: blank
SIP Accept Language	Accept-Language header used. There is no default (this indicates SPA9000 does not include this header). If empty, the header is not included.
DTMF Relay MIME Type	MIME Type used in a SIP INFO message to signal a DTMF event. Default: application/dtmf-relay
Hook Flash MIME Type	MIME Type used in a SIP INFO message to signal a hook flash event. Default: application/hook-flash
Remove Last Reg	Lets you remove the last registration before registering a new one if the value is different. Select yes or no from the drop-down menu. Default: no
Use Compact Header	Lets you use compact SIP headers in outbound SIP messages. Select yes or no from the drop-down menu. If set to yes, the SPA9000 uses compact SIP headers in outbound SIP messages. If set to no, the SPA9000 uses normal SIP headers. If inbound SIP requests contain compact headers, SPA9000 reuses the same compact headers when generating the response regardless the settings of the <Use Compact Header> parameter. If inbound SIP requests contain normal headers, SPA9000 substitutes those headers with compact headers (if defined by RFC 261) if <Use Compact Header> parameter is set to yes. Default: no
Escape Display Name	Select yes if you want the SPA9000 to enclose the string (configured in the Display Name) in a pair of double quotes for outbound SIP messages. Any occurrences of ' or \ in the string is escaped with \ and \\ inside the pair of double quotes. Otherwise, select no. Default: no

RFC 2543 Call Hold	If set to yes, unit will include c=0.0.0.0 syntax in SDP when sending a SIP re-INVITE to the peer to hold the call. If set to no, unit will not include the c=0.0.0.0 syntax in the SDP. The unit will always include a=sendonly syntax in the SDP in either case. Default: yes
Mark All AVT Packets	If set to yes, all AVT tone packets (encoded for redundancy) have the marker bit set. If set to no, only the first packet has the marker bit set for each DTMF event. Default: yes
SIP TCP Port Min	The lowest TCP port number that can be used for SIP sessions. Default: 5060
SIP TCP Port Max	The highest TCP port number that can be used for SIP sessions. Default: 5080

Voice tab > SIP page

SIP Timer Values (sec) section

SIP T1	RFC 3261 T1 value (RTT estimate), which can range from 0 to 64 seconds. Default: .5
SIP T2	RFC 3261 T2 value (maximum retransmit interval for non-INVITE requests and INVITE responses), which can range from 0 to 64 seconds. Default: 4
SIP T4	RFC 3261 T4 value (maximum duration a message remains in the network), which can range from 0 to 64 seconds. Default: 5
SIP Timer B	RFC 3261 INVITE transaction time-out value, which can range from 0 to 64 seconds. Default: 32
SIP Timer F	RFC 3261 Non-INVITE transaction time-out value, which can range from 0 to 64 seconds. Default: 32

SIP Timer H	RFC 3261 time-out value for ACK receipt, which can range from 0 to 64 seconds. Default: 32
SIP Timer D	RFC 3261 wait time for response retransmits, which can range from 0 to 64 seconds. Default: 32
SIP Timer J	RFC 3261 wait time for Non-INVITE response hang-around time, which can range from 0 to 64 seconds. Default: 32
INVITE Expires	INVITE request Expires header value. If you enter 0, the Expires header is not included in the request. Range: 0–(2 ³¹ –1). Default: 240
ReINVITE Expires	ReINVITE request Expires header value. If you enter 0, the Expires header is not included in the request. Range: 0–(2 ³¹ –1). Default: 30
Reg Min Expires	Minimum registration expiration time allowed from the proxy in the Expires header or as a Contact header parameter. If the proxy returns a value less than this setting, the minimum value is used. Default: 1
Reg Max Expires	Maximum registration expiration time allowed from the proxy in the Min-Expires header. If the value is larger than this setting, the maximum value is used. Default: 7200
Reg Retry Intvl	Interval to wait before the SPA9000 retries registration after failing during the last registration. Default: 30
Reg Retry Long Intvl	When registration fails with a SIP response code that does not match <Retry Reg RSC>, the SPA9000 waits for the specified length of time before retrying. If this interval is 0, the SPA9000 stops trying. This value should be much larger than the Reg Retry Intvl value, which should not be 0. Default: 1200
Reg Retry Random Delay	Random delay range (in seconds) to add to <Register Retry Intvl> when retrying REGISTER after a failure. Default: 0 (disabled)

Reg Retry Long Random Delay	Random delay range (in seconds) to add to <Register Retry Long Intvl> when retrying REGISTER after a failure. Default: 0 (disabled)
Reg Retry Intvl Cap	The maximum value to cap the exponential back-off retry delay (which starts at <Register Retry Intvl> and doubles on every REGISTER retry after a failure). In other words, the retry interval is always at <Register Retry Intvl> seconds after a failure. If this feature is enabled, <Reg Retry Random Delay> is added on top of the exponential back-off adjusted delay value. Default: 0 (disables the exponential back-off feature)

Voice tab > SIP page

Response Status Code Handling section

The RSC handling defines the behavior of the user audio tones played under specific conditions signaled by the network, such as congestion, queuing, etc. The default settings (blank) are adequate in most circumstances.



NOTE These settings need to be compatible with the ITSP network settings. The ITSP you use will inform you about any specific setting you need to modify on these areas. These parameters have impact on the signaling and audio reliability.

SIT1 RSC	SIP response status code for the appropriate Special Information Tone (SIT). For example, if you set the SIT1 RSC to 404, when the user makes a call and a failure code of 404 is returned, the SIT1 tone is played. Reorder or Busy Tone is played by default for all unsuccessful response status code for SIT 1 RSC through SIT 4 RSC.
SIT2 RSC	SIP response status code to INVITE on which to play the SIT2 Tone.
SIT3 RSC	SIP response status code to INVITE on which to play the SIT3 Tone.
SIT4 RSC	SIP response status code to INVITE on which to play the SIT4 Tone.
Try Backup RSC	SIP response code that retries a backup server for the current request.
Retry Reg RSC	Interval to wait before the SPA9000 retries registration after failing during the last registration.

Voice tab > SIP page

RTP Parameters section

The RTP parameters define the specification of the RTP audio packets. The most important parameter is the RTP Packet size (time) which defines the interval of transmission of the RTP packets. It is extremely important that time interval matches the ITSP settings. Its default value is 0.030 (30 milliseconds).



NOTE These settings need to be compatible with the ITSP network settings. The ITSP you use will inform you about any specific setting you need to modify on these areas. These parameters have impact on the signaling and audio reliability.

RTP Port Min	Minimum port number for RTP transmission and reception. <RTP Port Min> and <RTP Port Max> should define a range that contains at least 4 even number ports, such as 100 – 106. Default: 16384
RTP Port Max	Maximum port number for RTP transmission and reception. Default: 16482
RTP Packet Size	Packet size in seconds, which can range from 0.01 to 0.16. Valid values must be a multiple of 0.01 seconds. Default: 0.030
Max RTP ICMP Err	Number of successive ICMP errors allowed when transmitting RTP packets to the peer before the SPA9000 terminates the call. If value is set to 0, the SPA9000 ignores the limit on ICMP errors. Default: 0

RTCP Tx Interval	<p>Interval for sending out RTCP sender reports on an active connection. It can range from 0 to 255 seconds. During an active connection, the SPA9000 can be programmed to send out compound RTCP packet on the connection. Each compound RTP packet except the last one contains a SR (Sender Report) and a SDES.(Source Description). The last RTCP packet contains an additional BYE packet. Each SR except the last one contains exactly 1 RR (Receiver Report); the last SR carries no RR. The SDES contains CNAME, NAME, and TOOL identifiers. The CNAME is set to <User ID>@<Proxy>, NAME is set to <Display Name> (or Anonymous if user blocks caller ID), and TOOL is set to the Vendor/Hardware-platform-software-version (such as Linksys/SPA9000-1.0.31(b)). The NTP timestamp used in the SR is a snapshot of the SPA9000's local time, not the time reported by an NTP server. If the SPA9000 receives a RR from the peer, it attempts to compute the round trip delay and show it as the <Call Round Trip Delay> value (ms) in the Info section of SPA9000 web page.</p> <p>Default: 0</p>
No UDP Checksum	<p>Select yes if you want the SPA9000 to calculate the UDP header checksum for SIP messages. Otherwise, select no.</p> <p>Default: no</p>
Stats In BYE	<p>Determines whether the SPA9000 includes the P-RTP-Stat header or response to a BYE message. The header contains the RTP statistics of the current call. Select yes or no from the drop-down menu. The format of the P-RTP-Stat header is:</p> <p>P-RTP-State: PS=<packets sent>,OS=<octets sent>,PR=<packets received>,OR=<octets received>,PL=<packets lost>,JL=<jitter in ms>,LA=<delay in ms>,DU=<call duration in s>,EN=<encoder>,DE=<decoder>.</p> <p>Default: no</p>

Voice tab > SIP page

SDP Payload Types section

The SDP Payload types defines the naming/numbering conventions for the audio codecs used by the SPA9000 when communicating with the ITSP network. Naming should match the ITSP names used. The default values are adequate in most circumstances.

These settings need to be compatible with the ITSP network settings. The ITSP you use will inform you about any specific setting you need to modify on these areas. These parameters have impact on the signaling and audio reliability.

- *Dynamic Payloads:* The configured dynamic payloads are used for outbound calls only where the SPA9000 presents the SDP offer. For inbound calls with a SDP offer, the SPA9000 follows the caller dynamic payload type assignments.
- *Codec Names:* The SPA9000 uses the configured codec names in its outbound SDP. The SPA9000 ignores the codec names in incoming SDP for standard payload types (0 – 95). For dynamic payload types, the SPA9000 identifies the codec by the configured codec names. Comparison is case-insensitive.

NSE Dynamic Payload	NSE dynamic payload type. The valid range is 96-127. Default: 100
AVT Dynamic Payload	AVT dynamic payload type. The valid range is 96-127. Default: 101
INFOREQ Dynamic Payload	INFOREQ dynamic payload type. Default: blank
G726r16 Dynamic Payload	G.726-16 dynamic payload type. The valid range is 96-127. Default: 98
G726r24 Dynamic Payload	G.726-24 dynamic payload type. The valid range is 96-127. Default: 97
G726r40 Dynamic Payload	G.726-40 dynamic payload type. The valid range is 96-127. Default: 96
G729b Dynamic Payload	G.729b dynamic payload type. The valid range is 96-127. Default: 99
NSE Codec Name	NSE codec name used in SDP. Default: NSE
AVT Codec Name	AVT codec name used in SDP. Default: telephone-event
G711u Codec Name	G.711u codec name used in SDP. Default: PCMU
G711a Codec Name	G.711a codec name used in SDP. Default: PCMA
G726r16 Codec Name	G.726-16 codec name used in SDP. Default: G.726-16

G726r24 Codec Name	G.726-24 codec name used in SDP. Default: G.726-24
G726r32 Codec Name	G.726-32 codec name used in SDP. Default: G.726-32
G726r40 Codec Name	G.726-40 codec name used in SDP. Default: G.726-40
G729a Codec Name	G.729a codec name used in SDP. Default: G.729a
G729b Codec Name	G.729b codec name used in SDP. Default: G.729ab
G723 Codec Name	G.723 codec name used in SDP. Default: G.723
EncapRTP Codec Name	EncapRTP codec name used in SDP. Default: encaprtmp

Voice tab > SIP page

NAT Support Parameters section

Handle VIA received	If you select yes, the SPA9000 processes the received parameter in the VIA header (this value is inserted by the server in a response to any one of its requests). If you select no, the parameter is ignored. Select yes or no from the drop-down menu. Default: no
Handle VIA rport	If you select yes, the SPA9000 processes the rport parameter in the VIA header (this value is inserted by the server in a response to any one of its requests). If you select no, the parameter is ignored. Select yes or no from the drop-down menu. Default: no
Insert VIA received	Inserts the received parameter into the VIA header of SIP responses if the received-from IP and VIA sent-by IP values differ. Select yes or no from the drop-down menu. Default: no

Insert VIA rport	<p>Inserts the rport parameter into the VIA header of SIP responses if the received-from IP and VIA sent-by IP values differ. Select yes or no from the drop-down menu.</p> <p>Default: no</p>
Substitute VIA Addr	<p>Lets you use NAT-mapped IP-address port values in the VIA header. Select yes or no from the drop-down menu.</p> <p>Default: no</p>
Send Resp To Src Port	<p>Sends responses to the request source port instead of the VIA sent-by port. Select yes or no from the drop-down menu.</p> <p>Default: no</p>
STUN Enable	<p>Enables the use of STUN to discover NAT mapping. Select yes or no from the drop-down menu.</p> <p>Default: no</p>
STUN Test Enable	<p>If the STUN Enable feature is enabled and a valid STUN server is available, the SPA9000 can perform a NAT-type discovery operation when it powers on. It contacts the configured STUN server, and the result of the discovery is reported in a Warning header in all subsequent REGISTER requests. If the SPA9000 detects asymmetric NAT or asymmetric firewall, NAT mapping is disabled.</p> <p>Default: no</p>
STUN Server	<p>IP address or fully-qualified domain name of the STUN server to contact for NAT mapping discovery.</p> <p>Default: blank</p>
EXT IP	<p>External IP address to substitute for the actual IP address of the SPA9000 in all outgoing SIP messages. If 0.0.0.0 is specified, or the field is left blank, no IP address substitution is performed.</p> <p>NOTE You must also configure port forwarding for SIP [5060-5063] and RTP [16384-16482] when using the EXT IP field, or phone users may experience one-way audio because the RTP stream will not find its way between the two phones.</p> <p>If this parameter is specified, the SPA9000 assumes this IP address when generating SIP messages and SDP (if NAT Mapping is enabled for that line). However, the results of STUN and VIA received parameter processing, if available, supersede this statically configured value.</p> <p>Default: blank</p>

EXT RTP Port Min	External port mapping number of the RTP Port Min. number. If this value is not zero, the RTP port number in all outgoing SIP messages is substituted for the corresponding port value in the external RTP port range. Default: blank
NAT Keep Alive Intvl	Interval between NAT-mapping keep alive messages. Default: 15

Voice tab > SIP page

PBX Parameters section

Field	Description
Proxy Network Interface	This setting tells the SPA9000 how the client stations are connected. Choices: {LAN, WAN}. The SPA9000 communicates with client stations via the selected interface only. Default: WAN NOTE For optimum voice performance, Linksys Engineering and Quality Assurance recommend that only WAN is used.
Proxy Listen Port	Port at which the SPA9000 listens for client messages at the selected network interface. The proxy also sends SIP messages from this port. Default: 6060
Multicast Address	IP address (and port number) where the SPA9000 sends control messages to all the client stations at once. This must be a multicast address and must contain a port number. Default: 224.168.168.168:6061
Group Page Address	IP address (and port number) where the SPA9000 tells the client stations to send and receive group page RTP packets. This must be a multicast address and must contain a port number. Default: 224.168.168.168:34567
Max Expires	Sets the maximum allowed Registration expires value in seconds for client stations. Linksys recommends using a relatively small value, such as 60 or 120. Default: 60

Force Media Proxy	<p>Forces external client stations to use the SPA9000 Media Proxy when exchanging RTP traffic with external peers. Linksys recommends using a relatively small value, such as 60 or 120.</p> <p>Default: no</p>
Proxy Debug Option	<p>Controls what SIP messages to log that are received at or sent from the Proxy listen port. Choices are as follows: {</p> <p>none—No logging.</p> <p>1-line—Logs the start-line only for all messages,</p> <p>1-line excl. OPT—Same as 1-line but excludes OPTIONS request/response.</p> <p>1-line excl. NTFY—Same as 1-line but excludes NOTIFY request/response.</p> <p>1-line excl. REG—Same as 1-line but excludes REGISTER request/response.</p> <p>1-line excl. OPTINTFYIREG—Same as 1-line but excludes OPTIONS, NOTIFY, and REGISTER request/response.</p> <p>full—Logs all SIP messages in verbose mode.</p> <p>full excl. OPT—Same as full but excludes OPTIONS request/response.</p> <p>full excl. NTFY—Same as full but excludes NOTIFY request/response.</p> <p>full excl. REG—Same as full but excludes REGISTER request/response.</p> <p>full excl. OPTINTFYIREG—Same as full but excludes OPTIONS, NOTIFY, and REGISTER request/response.</p> <p>Default: None</p>

Call Routing Rule	<p>Special dial plan that determines which line interfaces can be used for an external outbound call request from client station based solely on the target public number. The dial plan is in the (<i>rule</i>/<i>rule</i>..<i>rule</i>) format where:</p> <p><i>rule</i> = <:L<i>n</i>[<i>n</i>][<i>n</i>][<i>n</i>]]><i>pattern</i></p> <p><i>n</i> = 1, 2, 3, or 4,</p> <p><i>pattern</i> = any digit pattern (see <Dial Plan> on how to choose a digit pattern).</p> <p>If the target number matches the pattern of a rule, the Line indices in the rule's prefix are the line interfaces that can be used to make that call. Matches are performed from left to right, so make sure the most specific rules are placed first. For example:</p> <p>Default: (<:L1,2,3,4>9xx.)</p> <p>The default call routing rule specifies that any of the four line interfaces can be used for any target number starting with 9 followed by at least 2 more numbers.</p>
Call Park MOH Server	<p>The MOH Server to be used to handle a parked call. For example: mohs@192.168.1.1:5082.</p> <p>If this parameter is not specified, the internal parking lot is used to host the parked call, in which case the parked caller hears the internal music file.</p> <p>Default: imusic</p>
Call Park DLG Refresh Intvl	<p>The interval in seconds between refreshing a call park session.</p> <p>Default: 0 (disables session refreshes)</p>
Default Group Line	<p>Same as <Group 1/2/3/4 Line>, but applies to the default group.</p> <p>Default: 1,2,3,4</p>
Group 1/2/3/4 User ID	<p>Comma-separated list of User ID patterns. A client station whose User ID matches any of the give patterns is considered to belong to that group. If the User ID matches more than one group, the smallest group number is assumed. If the User ID does not match any group, the client station is considered to belong to the default group (also known as Group 0). Each User ID pattern allows * and ? wildcards as well as %xx escaped characters.</p> <p>Default: blank (includes all client stations)</p>

Group 1/2/3/4 Line	<p>Ordered comma-separated list of line interfaces. The SPA9000 attempts to make external calls for group members in the order in which the lines are listed.</p> <p>Example: 1 , 3</p> <p>When a group member places an outbound call, the SPA9000 attempts to use Line 1 first. If Line 1 is not available, the SPA9000 attempts to use Line 3.</p> <p>By default, this field is blank, meaning that no line can be seized.</p>
Hunt Groups	<p>Defines one or more hunt groups that can be called directly by any client station like a regular extension. The syntax is the same as <Contact List>. Each defined group extension and name also appears in the corporate directory. This parameter is parsed twice by the SPA9000 such that a group member of one group can also be the extension of another group (that is, one level of recursion allowed).</p> <p>Default: blank</p>
SIP DIDN Field	<p>Determines which field is used to indicate the DID number for an incoming INVITE to a line interface. The choices are:</p> <p>TO UserID—The user-id field of the TO header</p> <p>TO Param—A parameter in the TO header with the name specified in <SIP DIDN Param Name>, such as didn=1234</p> <p>Default: TOUserID</p>
SIP DIDN Param Name	<p>Parameter name to indicate the DID number in an incoming INVITE message.</p> <p>Default: didn</p>
Accept All MWI as Line	<p>Choose the line. Choices are 1, 2, 3, 4, or Current.</p> <p>Default: Current</p>
Phone DLG Refresh Intvl	<p>Default: 0</p>

Voice tab > SIP page

Internal Music Source Parameters section

Internal Music URL	<p>URL from which to download a music file to be used by the parking lot. The format is:</p> <p>[tftp://]server-ip-addr[:port]/path</p> <p>TFTP is the only protocol supported for music download. Default port is 69. Changing the value of this parameter from the web interface triggers a graceful reboot of the SPA9000. If a valid entry is specified, the SPA9000 attempts to download the file on bootup and store the samples in flash memory. The SPA9000 remembers the link where the stored file is downloaded and does not try to download again on the next reboot.</p> <p>The music samples are encoded in G711u format at 8000 samples/second. The file should not contain any extra header information. Maximum length of the file is 65.536 seconds (524288 bytes).</p> <p>Default: blank</p>
--------------------	---

Internal Music Script	<p>Script that tells the SPA9000 how to play the downloaded music file, in the format [section[,section[,...]]], where:</p> <p><i>section</i> = $[[n](start/end[/pause])][pause2]$</p> <p><i>n</i> = number of times to repeat the section before moving to the next section. Default: 1</p> <p><i>start/end</i> = starting and 1+ending sample for this section; note that samples are numbered from 0 to total-length - 1. You may enter -1 or a very large number if the end of the file is intended as the ending sample. Default start is 0, and default end is end of the file.</p> <p><i>pause</i> = number of samples to pause after the ending sample is played. Default: 0</p> <p><i>pause2</i> = additional number of samples to pause after the entire <i>n</i> repetitions of the section are played. Default: 0</p> <p>A maximum of 16 sections can be specified. Samples should be encoded in G711u format at 8000 samples/second. When all sections are played, the SPA9000 replays from the first section again.</p> <p>Examples:</p> <p>40000 (plays the entire file, pauses for 5s, then repeats)</p> <p>2(0/32000),3(32000/100000/4000)2000,(100000/-1)80000</p>
Internal Music Refresh Intvl	<p>The interval in seconds between refreshing an internal music session.</p> <p>Default: 0 (disables session refreshes)</p>
Internal Music LBR Codec	<p>Selects one low bit-rate codec as an alternative to G711u and G711a for playing internal music. Choices are {none, G729a, G726-16, G726-24, G726-32, G726-40}.</p> <p>Default: none</p>
Internal Music Preferred Codec	<p>Selects which codec is the preferred choice to play internal music. Choices are {G711u, G711a, Low Bit Rate}. Low Bit Rate refers to the selected <Internal Music LBR Codec>. If <Internal Music LBR Codec> is none, G711u is the preferred codec also.</p> <p>Default: G711u</p>
Internal Music Use Pref Codec Only	<p>Forces the internal music player to use the preferred codec only.</p> <p>Default: no</p>

Voice tab > SIP page

Auto Attendant Parameters section

AA Dial Plan 1	Dial Plan 1 to be used in an AA script. Example: <dialplan src=dp1/>. Default: (10xlxxx.)
AA Dial Plan 2	Dial Plan 2 to be used in an AA script. Example: <dialplan src=dp2/>. Default: (<:10>xlxxx.)
AA script 1/2/3	AA script. See Chapter 7, "Configuring the Auto Attendant" , for the complete syntax. Default: <pre><aa><form id="dir" type="menu"> <audio src="prompt1" bargein= "T"/> <noinput timeout="10" repeat="T"/> <nomatch repeat="F"> <audio src="prompt3" bargein="T"/> </nomatch> <dialplan src= "dp1"/> <match> <default> <audio src="prompt2"/> <xfer name= "ext" target="\$input"/> </default></match> </form></aa></pre>
Daytime AA	To enable the daytime Auto-Attendant, select yes. Otherwise, select no. Default: yes
Day Time	Daytime hours for the daytime Auto-Attendant in 24-hour format. Enter the start and end times in this format: start=hh:mm:ss;end=hh:mm:ss (hh for hours, mm for minutes, and ss for seconds). For example, start=9:0:0;end=17:0:0 means that the start time is 9 AM and the end time is 5 PM. The other hours (5 PM to 9 AM) are considered nighttime hours. If you do not enter start and end times, the whole day (24 hours) is considered as daytime, so the nighttime Auto-Attendant is not used, even if it is enabled.
DayTime AA Script	Specifies which AA script (1, 2, or 3) is used for the AA treatment when operating in daytime mode. Default: 1

DayTime Answer Delay	Number of seconds before the AA answers when operating in the daytime mode. Default: 12
Nighttime AA	To enable the nighttime Auto-Attendant, select yes. Otherwise, select no. Default: no
NightTime AA Script	Specifies which AA script (1, 2, or 3) is used for the AA treatment when operating in daytime mode. Default: 1
NightTime Answer Delay	Number of seconds before the AA answers when operating in the nighttime mode. Default: 0
Weekend/Holiday AA	To enable this Auto-Attendant, select yes. Otherwise, select no. Default: no
Weekend/Holiday AA Script	Specifies which AA script (1, 2, or 3) is used for the AA treatment when operating in daytime mode. Default: 1
Weekends/Holidays	When the weekend/holiday Auto-Attendant is enabled, you can use this setting to specify the weekends and holidays. Up to four weekend days can be defined. Use this format: [wk=n1[,ni];][hd=mm/dd/yyyy mm/dd/yyyy-mm/dd/yyyy[,mm/dd/yyyy mm/dd/yyyy-mm/dd/yyyy];] (wk for weekend, which can be 1 for Monday to 7 for Sunday) (hd for holiday, which does not have to include the year) For example, wk=6,7;hd=1/1,2/21/2006,5/30/2006,12/19/2006-12/30/2006 means that Saturdays and Sundays are the weekends. Holidays are January 1-2, 2006; May 30, 2006; and December 19-30, 2006.
Weekend/Holiday Answer Delay	Number of seconds before the AA answers when operating in the weekend/holiday mode. Default: 0
AA LBR Codec	Selects one low bit rate codec as an alternative to G711u and G711a for playing AA prompts. Choices are {none, G729a, G726-16, G726-24, G726-32, G726-40}. Default: None

AA Preferred Codec	Selects which codec is the preferred choice to play AA prompts. Choices are {G711u, G711a, Low Bit Rate}. Low Bit Rate refers to the selected <AA LBR Codec>. If <AA LBR Codec> is none, G711u is the preferred codec also. Default: G711u
AA User Pref Codec Only	Forces the AA to use the preferred codec only. Default: no

AA Prompts URL Script	<p>Instructs the SPA9000 to erase or download user-recorded prompt files from a TFTP/HTTP/HTTPS server. These files must be encoded in G711u, size less than 60 seconds, with the header removed.</p> <p>The sum of the prompt files cannot be longer than 94.5 seconds. The prompt is downloaded when the device boots. If the prompt has already been downloaded from the given URL, the download does not occur. If prompt file name is none, the corresponding prompt currently saved in the flash is erased.</p> <p>Default: blank</p> <p>The following is the format of the prompt file:</p> <pre>serv=scheme://server_addr[:port]/root_path;[p1={prompt1 file path name};][p2={prompt2 file path name};][p3={prompt3 file path name};][p4={prompt4 file path name};][p5={prompt5 file path name};][p6={prompt6 file path name};][p7={prompt7 file path name};][p8={prompt8 file path name};][p9={prompt9 file path name};][p10={prompt10 file path name};]</pre> <p>Where:</p> <p>scheme = tftp http https</p> <p>default port is 69 for tftp, 80 for http, and 443 for https</p> <p>root_path can be empty</p> <p>[] denotes optional item</p> <p>For example:</p> <pre>serv=tftp://192.168.2.150/root/test/ ;p1=menu.wav;p2=transfer.wav;p3=nomatch.wav;p4=none;</pre> <p>The following shows the source for each prompt in this example:</p> <pre>prompt 1: tftp://192.168.2.150/root/test/menu.wav prompt 2: tftp://192.168.2.150/root/test/transfer.wav prompt 3: tftp://192.168.2.150/root/test/nomatch.wav prompt 4 is erased</pre>
-----------------------	---

Voice tab > SIP page

PBX Phone Parameters section

Next Auto User ID	User-id assigned to the next (unprovisioned) client station that requests initial profile from the SPA9000 internal configuration server. The parameter is automatically incremented once a new user-id is assigned. Default: 5000
Phone Ext Password	A REGISTRATION password to apply on Ext 1 of all the client stations. If password is not specified, all stations are allowed to register without being challenged by the SPA9000. Default: blank
Phone Upgrade Rule	Upgrade rule for all the client stations. For example: tftp://192.168.2.207/\$PN.bin Note that the \$PN macro is expanded to the product name of the client requesting the firmware. This allows upgrading phone clients with different firmware using a single rule. Default: blank
Phone Dial Plan	Dial plan for the client stations. Default: (*xx [3469]11 0 00 [2-9]xxxxxxx 1xxx [2-9]xxxxxxxS0 xxxxxxxxxxxxx.) This dial plan tells the phone to do the following: <ul style="list-style-type: none"> ▪ *xx: Allows any 3-character entry, with any character in the first position ▪ 3469]11: Allows 311, 411, 611, and 911 ▪ 0: Allows 0 ▪ 00: Allows 00 ▪ [2-9]xxxxxxx: Allows any 7-digit telephone number, as in a local call without an area code ▪ 1xxx [2-9]xxxxxxxS0: Allows any 10-digit telephone number starting with 1, as in a long distance call; with the S0 entry, the dialed digits are evaluated after 0 seconds ▪ xxxxxxxxxxxxx.: Allows any entry of 12 or more digits

Phone Config XML	<p>XML configuration to be served to the phones when they request the init_\$MA.xml file from the SPA9000 during their first-time initialization (either a brand-new phone or after a factory reset). If this parameter is empty, the SPA9000 serves the normal auto-generated startup XML configuration file to the phone instead.</p> <p>The purpose of this parameter is to facilitate ITSP provisioning of new phones remotely. ITSP can simply include a default phone profile rule parameter in this parameter so that the phone can obtain it from the SPA9000 on initial power-up. For example:</p> <pre><Profile_Rule>https://www.itsp.com/init/spa\$MA.cfg</Profile_Rule></pre> <p>Do not include <flat-profile>...</flat-profile>. The SPA9000 automatically adds them when serving the configuration file to the phones.</p> <p>Default: blank</p>
Use LVS_PROXY	<p>If this option is yes, the SPA9000 uses the hostname LVS_PROXY instead of its IP address in the Profile_Rule parameter that is served to the phones when they request init_\$MA.xml during first-time initialization (when <Phone Config XML> is not specified). On reboot, the phones resolve the LVS_PROXY by querying the LAN via multicast. The SPA9000 replies to the query with its actual IP address. This allows the SPA9000 to use a dynamically-assigned IP address that is not fixed.</p> <p>Make sure that the phones have a compatible firmware that understands that LVS_PROXY is a special hostname. For SPA-941/942/921/922/901, use 4.1.12 or later; for SPA-841, use 3.1.6(KS) or later.</p>
CTI Enable	<p>Enables or disables the Computer Telephone Interface feature provided by some servers.</p> <p>NOTE If you have a SPA962 with a SPA932 console, enable CTI to support busy lamp field (B LF).</p>

Voice tab >

Provisioning page

This page is available for service provider use only. Information is available in the *Linksys Provisioning Guide*, which is available only to service providers who are registered with Linksys.

Voice tab >

Regional page

You can use the *Regional* page to customize the tones and ring patterns, vertical service activation codes (star codes) and announcement codes, codec selection codes, and other regional settings such as time zone. This page includes the following sections:

- “Call Progress Tones section,” on page 224
- “Distinctive Ring Patterns section,” on page 226
- “Distinctive Call Waiting Tone Patterns section,” on page 227
- “Distinctive Ring/CWT Pattern Names section,” on page 228
- “Ring and Call Waiting Tone Spec section,” on page 229
- “Control Timer Values (sec) section,” on page 229
- “Vertical Service Activation Codes section,” on page 231
- “Vertical Service Announcement Codes section,” on page 236
- “Outbound Call Codec Selection Codes section,” on page 236
- “Miscellaneous section,” on page 237

Voice tab > Regional page

Call Progress Tones section

Dial Tone	Prompts the user to enter a phone number. Reorder Tone is played automatically when <Dial Tone> or any of its alternatives times out. Default: 350@-19,440@-19;10(* /0/1+2)
-----------	---

Second Dial Tone	Alternative to the Dial Tone when the user dials a three-way call. Default: 420@-19,520@-19;10(*0/1+2)
Outside Dial Tone	Alternative to the Dial Tone. It prompts the user to enter an external phone number, as opposed to an internal extension. It is triggered by a , (comma) character encountered in the dial plan. Default: 420@-16;10(*0/1)
Prompt Tone	Prompts the user to enter a call forwarding phone number. Default: 520@-19,620@-19;10(*0/1+2)
Busy Tone	Played when a 486 RSC is received for an outbound call. Default: 480@-19,620@-19;10(.5/.5/1+2)
Reorder Tone	Played when an outbound call has failed or after the far end hangs up during an established call. Reorder Tone is played automatically when <Dial Tone> or any of its alternatives times out. Default: 480@-19,620@-19;10(.25/.25/1+2)
Off Hook Warning Tone	Played when the caller has not properly placed the handset on the cradle. Off Hook Warning Tone is played when Reorder Tone times out. Default: 480@10,620@0;10(.125/.125/1+2)
Ring Back Tone	Played during an outbound call when the far end is ringing. Default: 440@-19,480@-19;*(2/4/1+2)
Confirm Tone	Brief tone to notify the user that the last input value has been accepted. Default: 600@-16; 1(.25/.25/1)
SIT1 Tone	Alternative to the Reorder Tone played when an error occurs as a caller makes an outbound call. The RSC to trigger this tone is configurable on the SIP screen. Default: 985@-16,1428@-16,1777@-16;20(.380/0/1,.380/0/2,.380/0/3,0/4/0)
SIT2 Tone	Alternative to the Reorder Tone played when an error occurs as a caller makes an outbound call. The response status code (RSC) to trigger this tone is configurable on the SIP screen. Default: 914@-16,1371@-16,1777@-16;20(.274/0/1,.274/0/2,.380/0/3,0/4/0)

SIT3 Tone	Alternative to the Reorder Tone played when an error occurs as a caller makes an outbound call. The RSC to trigger this tone is configurable on the SIP screen. Default: 914@-16,1371@-16,1777@-16;20(.380/0/1,.380/0/2,.380/0/3,0/4/0)
SIT4 Tone	This an alternative to the Reorder Tone played when an error occurs as a caller makes an outbound call. The RSC to trigger this tone is configurable on the SIP screen. Default: 985@-16,1371@-16,1777@-16;20(.380/0/1,.274/0/2,.380/0/3,0/4/0)
MWI Dial Tone	Played instead of the Dial Tone when there are unheard messages in the caller's mailbox. Default: 350@-19,440@-19;2(.1/.1/1+2);10(*0/1+2)
Cfwd Dial Tone	Played when all calls are forwarded. Default: 350@-19,440@-19;2(.2/.2/1+2);10(*0/1+2)
Holding Tone	Informs the local caller that the far end has placed the call on hold. Default: 600@-19*(.1/.1/1,.1/1/1,.1/9.5/1)
Conference Tone	Played to all parties when a three-way conference call is in progress. Default: 350@-19;20(.1/.1/1,.1/9.7/1)
Secure Call Indication Tone	Played when a call has been successfully switched to secure mode. It should be played only for a short while (less than 30 seconds) and at a reduced level (less than -19 dBm) so it does not interfere with the conversation. Default: 397@-19,507@-19;15(0/2/0,.2/.1/1,.1/2.1/2)
Feature Invocation Tone	Played when a feature is implemented. Default: 350@-16;*(.1/.1/1)

Voice tab > Regional page

Distinctive Ring Patterns section

Ring1 Cadence	Cadence script for distinctive ring 1. Default: 60(2/4)
Ring2 Cadence	Cadence script for distinctive ring 2. Default: 60(.8/.4,.8/4)

Ring3 Cadence	Cadence script for distinctive ring 3. Default: 60(.4/.2,.4/.2,.8/4)
Ring4 Cadence	Cadence script for distinctive ring 4. Default: 60(.3/.2,1/.2,.3/4)
Ring5 Cadence	Cadence script for distinctive ring 5. Default: 1(.5/.5)
Ring6 Cadence	Cadence script for distinctive ring 6. Default: 60(.2/.4,.2/.4,.2/4)
Ring7 Cadence	Cadence script for distinctive ring 7. Default: 60(.4/.2,.4/.2,.4/4)
Ring8 Cadence	Cadence script for distinctive ring 8. Default: 60(0.25/9.75)
Ring9 Cadence	Cadence script for distinctive ring 9. Default: 60(.4/.2,.4/2)

Voice tab > Regional page

Distinctive Call Waiting Tone Patterns section

CWT1 Cadence	Cadence script for distinctive CWT 1. Default: 30(.3/9.7)
CWT2 Cadence	Cadence script for distinctive CWT 2. Default: 30(.1/.1, .1/9.7)
CWT3 Cadence	Cadence script for distinctive CWT 3. Default: 30(.1/.1, .1/.1, .1/9.7)
CWT4 Cadence	Cadence script for distinctive CWT 4. Default: 30(.1/.1, .3/1, .1/9.3)
CWT5 Cadence	Cadence script for distinctive CWT 5. Default: 1(.5/.5)
CWT6 Cadence	Cadence script for distinctive CWT 6. Default: 30(.1/.1,.3/.2,.3/9.1)
CWT7 Cadence	Cadence script for distinctive CWT 7. Default: 30(.3/.1,.3/.1,.1/9.1)

CWT8 Cadence	Cadence script for distinctive CWT 8. Default: 2.3(.3/2)
CWT9 Cadence	Cadence script for distinctive CWT 9. Default: 30(.3/9.7)

Voice tab > Regional page

Distinctive Ring/CWT Pattern Names section

Ring1 Name	Name in an INVITE's Alert-Info Header to pick distinctive ring/CWT 1 for the inbound call. Default: Bellcore-r1
Ring2 Name	Name in an INVITE's Alert-Info Header to pick distinctive ring/CWT 2 for the inbound call. Default: Bellcore-r2
Ring3 Name	Name in an INVITE's Alert-Info Header to pick distinctive ring/CWT 3 for the inbound call. Default: Bellcore-r3
Ring4 Name	Name in an INVITE's Alert-Info Header to pick distinctive ring/CWT 4 for the inbound call. Default: Bellcore-r4
Ring5 Name	Name in an INVITE's Alert-Info Header to pick distinctive ring/CWT 5 for the inbound call. Default: Bellcore-r5
Ring6 Name	Name in an INVITE's Alert-Info Header to pick distinctive ring/CWT 6 for the inbound call. Default: Bellcore-r6
Ring7 Name	Name in an INVITE's Alert-Info Header to pick distinctive ring/CWT 7 for the inbound call. Default: Bellcore-r7
Ring8 Name	Name in an INVITE's Alert-Info Header to pick distinctive ring/CWT 8 for the inbound call. Default: Bellcore-r8
Ring9 Name	Name in an INVITE's Alert-Info Header to pick distinctive ring/CWT 9 for the inbound call. Default: Bellcore-r9

Voice tab > Regional page

Ring and Call Waiting Tone Spec section

Ring Waveform	Waveform for the ringing signal: Sinusoid or Trapezoid. Default: Trapezoid
Ring Frequency	Frequency of the ringing signal. Valid values are 10–100 (Hz). Default: 0
Ring Voltage	Ringing voltage. 60–90 (V). Default: 85
CWT Frequency	Frequency script of the call waiting tone. All distinctive CWTs are based on this tone. Default: 440@-10

Voice tab > Regional page

Control Timer Values (sec) section

Hook Flash Timer Min	Minimum on-hook time before off-hook qualifies as hook-flash. Less than this the on-hook event is ignored. Range: 0.1–0.4 seconds. Default: .1
Hook Flash Timer Max	Maximum on-hook time before off-hook qualifies as hook-flash. More than this the on-hook event is treated as on-hook (no hook-flash event). Range: 0.4–1.6 seconds. Default: .9
Callee On Hook Delay	Phone must be on-hook for at this time in sec before the SPA9000 tears down the current inbound call. It does not apply to outbound calls. Range: 0–255 seconds. Default: 0
Reorder Delay	Delay after far end hangs up before reorder tone is played. 0 = plays immediately, inf = never plays. Range: 0–255 seconds. Default: 5
Call Back Expires	Expiration time in seconds of a call back activation. Range: 0–65535 seconds. Default: 1800

Call Back Retry Intvl	Call back retry interval in seconds. Range: 0–255 seconds. Default: 30
Call Back Delay	Delay after receiving the first SIP 18x response before declaring the remote end is ringing. If a busy response is received during this time, the SPA9000 still considers the call as failed and keeps on retrying. Default: .5
VMWI Refresh Intvl	Interval between VMWI refresh to the CPE. Default: 0
Interdigit Long Timer	Long timeout between entering digits when dialing. The interdigit timer values are used as defaults when dialing. The Interdigit_Long_Timer is used after any one digit, if all valid matching sequences in the dial plan are incomplete as dialed. Range: 0–64 seconds. Default: 10
Interdigit Short Timer	Short timeout between entering digits when dialing. The Interdigit_Short_Timer is used after any one digit, if at least one matching sequence is complete as dialed, but more dialed digits would match other as yet incomplete sequences. Range: 0–64 seconds. Default: 3
CPC Delay	Delay in seconds after caller hangs up when the SPA9000 starts removing the tip-and-ring voltage to the attached equipment of the called party. Range: 0–255 seconds. SPA9000 has had polarity reversal feature since release 1.0 which can be applied to both the caller and the callee end. This feature is generally used for answer supervision on the caller side to signal to the attached equipment when the call has been connected (remote end has answered) or disconnected (remote end has hung up). This feature should be disabled for the called party (in other words, by using the same polarity for connected and idle state) and the CPC feature should be used instead. Without CPC enabled, reorder tone is played after a configurable delay. If CPC is enabled, dial tone is played when tip-to-ring voltage is restored Resolution is 1 second. Default: 2

CPC Duration	Duration in seconds for which the tip-to-ring voltage is removed after the caller hangs up. After that, tip-to-ring voltage is restored and dial tone applies if the attached equipment is still off-hook. CPC is disabled if this value is set to 0. Range: 0 to 1.000 second. Resolution is 0.001 second. Default: 0 (CPC disabled)
--------------	---

Voice tab > Regional page

Vertical Service Activation Codes section



NOTE Vertical Service Activation Codes are automatically appended to the dial-plan. There is no need to include them in dial-plan, although no harm is done if they are included.

Call Return Code	This code calls the last caller. Default: *69
Call Redial Code	Redials the last number called. Default: *07
Blind Transfer Code	Begins a blind transfer of the current call to the extension specified after the activation code. Default: *98
Call Back Act Code	Starts a callback when the last outbound call is not busy. Default: *66
Call Back Deact Code	Cancels a callback. Default: *86
Call Back Busy Act Code	Starts a callback when the last outbound call is busy. Default: *05
Cfwd All Act Code	Forwards all calls to the extension specified after the activation code. Default: *72
Cfwd All Deact Code	Cancels call forwarding of all calls. Default: *73
Cfwd Busy Act Code	Forwards busy calls to the extension specified after the activation code. Default: *90

Cfwd Busy Deact Code	<p>Cancels call forwarding of busy calls.</p> <p>Default: *91</p>
Cfwd No Ans Act Code	<p>Forwards no-answer calls to the extension specified after the activation code.</p> <p>Default: *92</p>
Cfwd No Ans Deact Code	<p>Cancels call forwarding of no-answer calls.</p> <p>Default: *93</p>
Cfwd Last Act Code	<p>Forwards the last inbound or outbound calls to the extension specified after the activation code.</p> <p>Default: *63</p>
Cfwd Last Deact Code	<p>Cancels call forwarding of the last inbound or outbound calls.</p> <p>Default: *83</p>
Block Last Act Code	<p>Blocks the last inbound call.</p> <p>Default: *60</p>
Block Last Deact Code	<p>Cancels blocking of the last inbound call.</p> <p>Default: *80</p>
Accept Last Act Code	<p>Accepts the last outbound call. It lets the call ring through when do not disturb or call forwarding of all calls are enabled.</p> <p>Default: *64</p>
Accept Last Deact Code	<p>Cancels the code to accept the last outbound call.</p> <p>Default: *84</p>
CW Act Code	<p>Enables call waiting on all calls.</p> <p>Default: *56</p>
CW Deact Code	<p>Disables call waiting on all calls.</p> <p>Default: *57</p>
CW Per Call Act Code	<p>Enables call waiting for the next call.</p> <p>Default: *71</p>
CW Per Call Deact Code	<p>Disables call waiting for the next call.</p> <p>Default: *70</p>
Block CID Act Code	<p>Blocks caller ID on all outbound calls.</p> <p>Default: *67</p>
Block CID Deact Code	<p>Removes caller ID blocking on all outbound calls.</p> <p>Default: *68</p>
Block CID Per Call Act Code	<p>Blocks caller ID on the next outbound call.</p> <p>Default: *81</p>

Block CID Per Call Deact Code	Removes caller ID blocking on the next inbound call. Default: *82
Block ANC Act Code	Blocks all anonymous calls. Default: *77
Block ANC Deact Code	Removes blocking of all anonymous calls. Default: *87
DND Act Code	Enables the do not disturb feature. Default: *78
DND Deact Code	Disables the do not disturb feature. Default: *79
CID Act Code	Enables caller ID generation. Default: *65
CID Deact Code	Disables caller ID generation. Default: *85
CWCID Act Code	Enables call waiting, caller ID generation. Default: *25
CWCID Deact Code	Disables call waiting, caller ID generation. Default: *45
Dist Ring Act Code	Enables the distinctive ringing feature. Default: *26
Dist Ring Deact Code	Disables the distinctive ringing feature. Default: *46
Speed Dial Act Code	Assigns a speed dial number. Default: *74
Secure All Call Act Code	Makes all outbound calls secure. Default: *16
Secure No Call Act Code	Makes all outbound calls not secure. Default: *17
Secure One Call Act Code	Makes the next outbound call secure. (It is redundant if all outbound calls are secure by default.) Default: *18
Secure One Call Deact Code	Makes the next outbound call not secure. (It is redundant if all outbound calls are not secure by default.) Default: *19
Conference Act Code	If this code is specified, the user must enter it before dialing the third party for a conference call. Enter the code for a conference call.

Attn-Xfer Act Code	If the code is specified, the user must enter it before dialing the third party for a call transfer. Enter the code for a call transfer.
Modem Line Toggle Code	Toggles the line to a modem. Default: *99 . Modem pass-through mode can be triggered only by pre-dialing this code.
FAX Line Toggle Code	Toggles the line to a fax machine. Default: #99
Referral Services Codes	<p>These codes tell the SPA9000 what to do when the user places the current call on hold by hook flash and is listening to the second dial tone.</p> <p>One or more *codes can be configured into this parameter, such as *98, or *97!*98!*123, etc. Max length is 79 chars. Each *code (and the following valid target number according to current dial plan) entered on the second dial-tone triggers the SPA9000 to perform a blind transfer to a target number that is prepended by the service *code.</p> <p>For example, after the user dials *98, the SPA9000 plays a special dial tone called the Prompt Tone while waiting for the user to enter a target number (which is checked according to dial plan as in normal dialing). When a complete number is entered, the SPA9000 sends a blind REFER to the holding party with the Refer-To target equals to *98<target_number>. This feature allows the SPA9000 to hand off a call to an application server to perform further processing, such as call park.</p> <p>The *codes should not conflict with any of the other vertical service codes internally processed by the SPA9000. You can empty the corresponding *code that you do not want to SPA9000 to process.</p> <p>Default: blank</p>

Feature Dial Services Codes	<p>These codes tell the Linksys ATA what to do when the user is listening to the first or second dial tone.</p> <p>One or more *code can be configured into this parameter, such as *72, or *72!*74!*67!*82, etc. Max total length is 79 chars. This parameter applies when the user has a dial tone (first or second dial tone). Enter *code (and the following target number according to current dial plan) entered at the dial tone triggers the Linksys ATA to call the target number prepended by the *code. For example, after user dials *72, the Linksys ATA plays a prompt tone awaiting the user to enter a valid target number. When a complete number is entered, the Linksys ATA sends a INVITE to *72<target_number> as in a normal call. This feature allows the proxy to process features like call forward (*72) or BLock Caller ID (*67).</p> <p>The *codes should not conflict with any of the other vertical service codes internally processed by the Linksys ATA. You can empty the corresponding *code that you do not want to Linksys ATA to process.</p> <p>You can add a parameter to each *code in Features Dial Services Codes to indicate what tone to play after the *code is entered, such as *72'c'!*67'p'. Below are a list of allowed tone parameters (note the use of back quotes surrounding the parameter w/o spaces)</p> <ul style="list-style-type: none"> ▪ 'c' = <Cfwd Dial Tone> ▪ 'd' = <Dial Tone> ▪ 'm' = <MWI Dial Tone> ▪ 'o' = <Outside Dial Tone> ▪ 'p' = <Prompt Dial Tone> ▪ 's' = <Second Dial Tone> ▪ 'x' = No tones are place, x is any digit not used above <p>If no tone parameter is specified, the Linksys ATA plays Prompt tone by default.</p> <p>If the *code is not to be followed by a phone number, such as *73 to cancel call forwarding, do not include it in this parameter. In that case, simple add that *code in the dial plan and the Linksys ATA send INVITE *73@..... as usual when user dials *73.</p>
Media Loopback Code	Default: *03

Voice tab > Regional page

Vertical Service Announcement Codes section

Service Annc Base Number	Base number for service announcements.
Service Annc Extension Codes	Extension codes for service announcements.

Voice tab > Regional page

Outbound Call Codec Selection Codes section



NOTE These codes automatically appended to the dial-plan. So no need to include them in dial-plan (although no harm to do so either).

Prefer G711u Code	Makes this codec the preferred codec for the associated call. Default: *017110.
Force G711u Code	Makes this codec the only codec that can be used for the associated call. Default: *027110.
Prefer G711a Code	Makes this codec the preferred codec for the associated call. Default: *017111
Force G711a Code	Makes this codec the only codec that can be used for the associated call. Default: *027111.
Prefer G723 Code	Makes this codec the preferred codec for the associated call. Default: *01723.
Force G723 Code	Makes this codec the only codec that can be used for the associated call. Default: *02723.
Prefer G726r16 Code	Makes this codec the preferred codec for the associated call. Default: *0172616.

Force G726r16 Code	Makes this codec the only codec that can be used for the associated call. Default: *0272616.
Prefer G726r24 Code	Makes this codec the preferred codec for the associated call. Default: *0172624.
Force G726r24 Code	Makes this codec the only codec that can be used for the associated call. Default: *0272624.
Prefer G726r32 Code	Makes this codec the preferred codec for the associated call. Default: *0172632.
Force G726r32 Code	Makes this codec the only codec that can be used for the associated call. Default: *0272632.
Prefer G726r40 Code	Makes this codec the preferred codec for the associated call. Default: *0172640.
Force G726r40 Code	Makes this codec the only codec that can be used for the associated call. Default: *0272640.
Prefer G729a Code	Makes this codec the preferred codec for the associated call. Default: *01729.
Force G729a Code	Makes this codec the only codec that can be used for the associated call. Default: *02729.

Voice tab > Regional page

Miscellaneous section

Set Local Date (mm/dd)	Sets the local date (mm stands for months and dd stands for days). The year is optional and uses two or four digits. Default: blank
Set Local Time (HH/mm)	Sets the local time (hh stands for hours and mm stands for minutes). Seconds are optional. Default: blank

Time Zone	<p>Selects the number of hours to add to GMT to generate the local time for caller ID generation. Choices are GMT-12:00, GMT-11:00, ..., GMT, GMT+01:00, GMT+02:00, ..., GMT+13:00.</p> <p>Default: GMT-08:00</p>
FXS Port Impedance	<p>Sets the electrical impedance of the FXS port. Choices are 600, 900, 600+2.16uF, 900+2.16uF, 270+750 150nF, 220+850 120nF, 220+820 115nF, or 200+600 100nF.</p> <p>Default: 600</p>
Daylight Saving Time Rule	<p>Enter the rule for calculating daylight saving time; it should include the start, end, and save values. This rule is comprised of three fields. Each field is separated by ; (a semicolon) as shown below. Optional values inside [] (the brackets) are assumed to be 0 if they are not specified. Midnight is represented by 0:0:0 of the given date.</p> <p>SYNTAX: <code>start = <start-time>; end=<end-time>; save = <save-time></code></p> <p>The <start-time> and <end-time> values specify the start and end dates and times of daylight saving time. Each value is in this format: <month> /<day> / <weekday>[/HH:[mm[:ss]]]</p>

Daylight Saving Time Rule (continued)	<p>The <save-time> value is the number of hours, minutes, and/or seconds to add to the current time during daylight saving time. The <save-time> value can be preceded by a negative (-) sign if subtraction is desired instead of addition. The <save-time> value is in this format: <code>[/[+]-]HH:[mm[:ss]]</code></p> <p>The <month> value equals any value in the range 1-12 (January-December).</p> <p>The <day> value equals [+/-] any value in the range 1-31.</p> <p>If <day> is 1, it means the <weekday> on or before the end of the month (in other words the last occurrence of < weekday> in that month).</p> <p>The <weekday> value equals any value in the range 1-7 (Monday-Sunday). It can also equal 0. If the <weekday> value is 0, this means that the date to start or end daylight saving is exactly the date given. In that case, the <day> value must not be negative. If the <weekday> value is not 0 and the <day> value is positive, then daylight saving starts or ends on the <weekday> value on or after the date given. If the <weekday> value is not 0 and the <day> value is negative, then daylight saving starts or ends on the <weekday> value on or before the date given.</p> <p>The abbreviation HH stands for hours (0-23).</p> <p>The abbreviation mm stands for minutes (0-59).</p> <p>The abbreviation ss stands for seconds (0-59).</p> <p>The default Daylight Saving Time Rule is start=4/1/7;end=10/-1/7;save=1.</p>
FXS Port Input Gain	<p>Input gain in dB, up to three decimal places. The range is 6.000 to -12.000.</p> <p>Default: -3.</p>
FXS Port Output Gain	<p>Output gain in dB, up to three decimal places. The range is 6.000 to -12.000. The Call Progress Tones and DTMF playback level are not affected by the <FXS Port Output Gain>.</p> <p>Default: -3</p>
DTMF Playback Level	<p>Local DTMF playback level in dBm, up to one decimal place.</p> <p>Default: -16.0</p>
DTMF Playback Length	<p>Local DTMF playback duration in milliseconds.</p> <p>Default: .1</p>

Detect ABCD	To enable local detection of DTMF ABCD, select yes . Otherwise, select no . Setting has no effect if DTMF Tx Method is INFO; ABCD is always sent OOB regardless in this setting. Default: yes
Playback ABCD	To enable local playback of OOB DTMF ABCD, select yes . Otherwise, select no . Default: yes
Caller ID Method	The following choices are available: Bellcore (N.Amer,China)—CID, CIDCW, and VMWI. FSK sent after first ring (same as ETSI FSK sent after first ring) (no polarity reversal or DTAS). DTMF (Finland, Sweden)—CID only. DTMF sent after polarity reversal (and no DTAS) and before first ring. DTMF (Denmark)—CID only. DTMF sent after polarity reversal (and no DTAS) and before first ring. ETSI DTMF—CID only. DTMF sent after DTAS (and no polarity reversal) and before first ring. ETSI DTMF With PR—CID only. DTMF sent after polarity reversal and DTAS and before first ring. ETSI DTMF After Ring—CID only. DTMF sent after first ring (no polarity reversal or DTAS). ETSI FSK—CID, CIDCW, and VMWI. FSK sent after DTAS (but no polarity reversal) and before first ring. Waits for ACK from CPE after DTAS for CIDCW. ETSI FSK With PR (UK)—CID, CIDCW, and VMWI. FSK is sent after polarity reversal and DTAS and before first ring. Waits for ACK from CPE after DTAS for CIDCW. Polarity reversal is applied only if equipment is on hook. Default: Bellcore(N.Amer, China)
Caller ID FSK Standard	The SPA9000 supports bell 202 and v.23 standards for caller ID generation. Select the FSK standard you want to use, bell 202 or v.23 . Default: bell 202
Feature Invocation Method	Select the method you want to use, Default or Sweden default . Default: Default

More Echo Suppression	Enable or disable more echo suppression. Default: no
-----------------------	--

Voice tab >

FXS 1/2 page

You can use the *FXS 1* page and the *FXS 2* page to configure the settings for the FXS devices that are connected to the Phone 1 and Phone 2 ports of the SPA9000.

- “Line Enable section,” on page 241
- “Network Settings section,” on page 242
- “SIP Settings section,” on page 242
- “Subscriber Information section,” on page 244
- “Dial Plan section,” on page 244
- “Mailbox Status section,” on page 245
- “Streaming Audio Server (SAS) section,” on page 245
- “Call Feature Settings section,” on page 246
- “Audio Configuration section,” on page 247
- “FXS Port Polarity Configuration section,” on page 251

Voice tab > FXS 1/2 page

Line Enable section

Line Enable	Enables this line for service (yes) or removes this line from service (no) Default: yes
-------------	---

Voice tab > FXS 1/2 page

Network Settings section

SIP ToS/DiffServ Value	TOS/DiffServ field value in UDP IP packets carrying a SIP message. Default: 0x68
SIP CoS Value [0-7]	CoS value for SIP messages. Default: 3
RTP ToS/DiffServ Value	ToS/DiffServ field value in UDP IP packets carrying RTP data. Default: 0xb8
RTP CoS Value [0-7]	CoS value for RTP data. Default: 6
Network Jitter Level	Determines how jitter buffer size is adjusted by the SPA9000. Jitter buffer size is adjusted dynamically. The minimum jitter buffer size is 30 milliseconds or (10 milliseconds + current RTP frame size), whichever is larger, for all jitter level settings. However, the starting jitter buffer size value is larger for higher jitter levels. This setting controls the rate at which the jitter buffer size is adjusted to reach the minimum. Select the appropriate setting: low, medium, high, very high, or extremely high . Default: high
Jitter Buffer Adjustment	Controls how the jitter buffer should be adjusted. Select the appropriate setting: up and down, up only, down only, or disable . Default: up and down

Voice tab > FXS 1/2 page

SIP Settings section

SIP Port	Port number of the SIP message listening and transmission port. Default: 5080
SIP Remote-Party-ID	To use the Remote-Party-ID header instead of the From header, select yes. Otherwise, select no. Default: yes

SIP Debug Option	<p>SIP messages are received at or sent from the proxy listen port. This feature controls which SIP messages to log. The choices are as follows:</p> <p>none—No logging.</p> <p>1-line—Logs the start-line only for all messages.</p> <p>1-line excl. OPT—Logs the start-line only for all messages except OPTIONS requests/responses.</p> <p>1-line excl. NTFY—Logs the start-line only for all messages except NOTIFY requests/responses.</p> <p>1-line excl. REG—Logs the start-line only for all messages except REGISTER requests/responses.</p> <p>1-line excl. OPTINTFYIREG—Logs the start-line only for all messages except OPTIONS, NOTIFY, and REGISTER requests/responses.</p>
SIP Debug Option (continued)	<p>full—Logs all SIP messages in verbose mode.</p> <p>full excl. OPT—Logs all SIP messages in full text except OPTIONS requests/responses.</p> <p>full excl. NTFY—Logs all SIP messages in full text except NOTIFY requests/responses.</p> <p>full excl. REG—Logs all SIP messages in full text except REGISTER requests/responses.</p> <p>full excl. OPTINTFYIREG—Logs all SIP messages in full text except for OPTIONS, NOTIFY, and REGISTER requests/responses.</p> <p>Default: none</p>
Restrict Source IP	<p>If line interfaces use the same SIP Port value and the Restrict Source IP feature is enabled, the proxy IP address for Lines 1 and 2 is treated as an acceptable IP address for both lines. To enable the Restrict Source IP feature, select yes. Otherwise, select no.</p> <p>A source IP address is untrusted if it does not match any of the IP addresses resolved from the configured Proxy or Outbound Proxy if Use Outbound Proxy is set to yes.</p> <p>Default: no</p>

Referor Bye Delay	Controls when the SPA9000 sends BYE to terminate stale call legs after completion of call transfers. Multiple delay settings (Referor, Refer Target, Referee, and Refer-To Target) are configured on this screen. For the Referor Bye Delay, enter the appropriate period of time in seconds. Default: 4
Refer Target Bye Delay	For the Refer Target Bye Delay, enter the appropriate period of time in seconds. Default: 0
Referee Bye Delay	For the Referee Bye Delay, enter the appropriate period of time in seconds. Default: 0
Refer-To Target Contact	To contact the refer-to target, select yes. Otherwise, select no. Default: no
Sticky 183	If this feature is enabled, the IP telephony ignores further 180 SIP responses after receiving the first 183 SIP response for an outbound INVITE. To enable this feature, select yes. Otherwise, select no. Default: no

Voice tab > FXS 1/2 page

Subscriber Information section

Display Name	Display name for caller ID.
User ID	Extension number for this line.

Voice tab > FXS 1/2 page

Dial Plan section

Dial Plan	Dial plan script for this line.
-----------	---------------------------------

Voice tab > FXS 1/2 page

Mailbox Status section

Message Waiting	Indicates whether you have new voicemail waiting.
-----------------	---

Voice tab > FXS 1/2 page

Streaming Audio Server (SAS) section

SAS Enable	To enable the use of the line as a streaming audio source, select yes. Otherwise, select no. If enabled, the line cannot be used for outgoing calls. Instead, it auto-answers incoming calls and streams audio RTP packets to the caller. Default: no
SAS DLG Refresh Intvl	If this value is not zero, it is the interval at which the streaming audio server sends out session refresh (SIP re-INVITE) messages to determine whether the connection to the caller is still active. If the caller does not respond to the refresh message, the SPA9000 ends this call with a SIP BYE message. The range is 0 to 255 seconds (0 means that the session refresh is disabled). Default: 30

SAS Inbound RTP Sink	<p>This setting works around devices that do not play inbound RTP if the streaming audio server line declares itself as a send-only device and tells the client not to stream out audio. Enter a Fully Qualified Domain Name (FQDN) or IP address of an RTP sink; this value is used by the SPA9000's streaming audio server line in the SDP of its 200 response to an inbound INVITE message from a client.</p> <p>The purpose of this parameter is to work around devices that do not play inbound RTP if the SAS line declares itself as a "sendonly" device and tells the client not to stream out audio. This parameter is a FQDN or IP address of a RTP sink to be used by the SPA SAS line in the SDP of its 200 response to inbound INVITE from a client. It will appear in the c = line and the port number and, if specified, in the m = line of the SDP. If this value is not specified or equal to 0, then c = 0.0.0.0 and a=sendonly is used in the SDP to tell the SAS client to not to send any RTP to this SAS line. If a non-zero value is specified, then a=sendrecv and the SAS client will stream audio to the given address. Special case: If the value is \$IP, then the SAS line's own IP address is used in the c = line and a=sendrecv. In that case the SAS client will stream RTP packets to the SAS line.</p> <p>Default: blank</p>
----------------------	---

Voice tab > FXS 1/2 page

Call Feature Settings section

Blind Attn-Xfer Enable	<p>Enables the SPA9000 to perform an attended transfer operation by ending the current call leg and performing a blind transfer of the other call leg. If this feature is disabled, the SPA9000 performs an attended transfer operation by referring the other call leg to the current call leg while maintaining both call legs. To use this feature, select yes. Otherwise, select no.</p> <p>Default: no</p>
MOH Server	<p>User ID or URL of the auto-answering streaming audio server. When only a user ID is specified, the current or outbound proxy is contacted. Music-on-hold is disabled if the MOH Server is not specified.</p>
Xfer When Hangup Conf	<p>Makes the SPA9000 perform a transfer when a conference call has ended. Select yes or no from the drop-down menu.</p> <p>Default: Yes</p>

Conference Bridge URL	This feature supports external conference bridging for n-way conference calls ($n > 2$), instead of mixing audio locally. To use this feature, set this parameter to that of the server's name; for example, <code>conf@myserver.com:12345</code> or <code>conf</code> (which uses the Proxy value as the domain). Default: blank
Conference Bridge Ports	Maximum number of conference call participants. The range is 3 to 10. Default: 3
Enable IP Dialing	To use IP dialing, select yes. Otherwise, select no. Default: no
Emergency Number	Comma-separated list of emergency number patterns. If an outbound call matches one of the patterns, the SPA9000 disables call waiting, hook flash event handling, and fax tone detection. Operation is restored to normal when the phone is on-hook again. If you leave this field blank, the SPA9000 has no emergency number.
Mailbox ID	Enter the ID number of the mailbox for this line.

Voice tab > FXS 1/2 page

Audio Configuration section



NOTE A codec resource is considered as allocated if it has been included in the SDP codec list of an active call, even though it eventually may not be the one chosen for the connection. So, if the G.729a codec is enabled and included in the codec list, that resource is tied up until the end of the call whether or not the call actually uses G.729a. If the G.729a resource is already allocated and since only one G.729a resource is allowed per device, no other low-bit-rate codec may be allocated for subsequent calls; the only choices are G711a and G711u. On the other hand, two G.723.1/G.726 resources are available per device. Therefore it is important to disable the use of G.729a in order to guarantee the support of two simultaneous G.723/G.726 codecs.

Preferred Codec	Preferred codec for all calls. (The actual codec used in a call still depends on the outcome of the codec negotiation protocol.) Select one of the following: G711u, G711a, G726-16, G726-24, G726-32, G726-40, G729a, or G723 Default: G711u
-----------------	--

Second Preferred Codec, Third Preferred Codec	Other codecs to be preferred if the preferred codec is not available due to the codec negotiation protocol. Default: Unspecified
Use Pref Codec Only	If set to yes, the call can be completed only with the preferred codec. Default: no
Silence Supp Enable	To enable silence suppression so that silent audio frames are not transmitted, select yes. Otherwise, select no. Default: no
Use Pref Codec Only	To use only the preferred codec for all calls, select yes. (The call fails if the far end does not support this codec.) Otherwise, select no. Default: no
Silence Threshold	Select the appropriate setting for the threshold: high, medium, or low. Default: medium
G729a Enable	To enable the use of the G729a codec at 8 kbps, select yes. Otherwise, select no. Default: yes
Echo Canc Enable	To enable the use of the echo canceller, select yes. Otherwise, select no. Default: yes
G723 Enable	To enable the use of the G723a codec at 6.3 kbps, select yes. Otherwise, select no. Default: yes
Echo Canc Adapt Enable	To enable the echo canceller to adapt, select yes. Otherwise, select no. Default: yes
G726-16 Enable	To enable the use of the G726 codec at 16 kbps, select yes. Otherwise, select no. Default: yes
Echo Supp Enable	To enable the use of the echo suppressor, select yes. Otherwise, select no. Default: yes
G726-24 Enable	To enable the use of the G726 codec at 24 kbps, select yes. Otherwise, select no. Default: yes

FAX CED Detect Enable	To enable detection of the fax Caller-Entered Digits (CED) tone, select yes. Otherwise, select no. Default: yes
G726-32 Enable	To enable the use of the G726 codec at 32 kbps, select yes. Otherwise, select no. Default: yes
FAX CNG Detect Enable	To enable detection of the fax Calling Tone (CNG), select yes. Otherwise, select no. Default: yes
G726-40 Enable	To enable the use of the G726 codec at 40 kbps, select yes. Otherwise, select no. Default: yes
FAX Passthru Codec	Select the codec for fax passthrough, G711u or G711a. Default: G711u
DTMF Process INFO	To use the DTMF process info feature, select yes. Otherwise, select no. Default: yes
FAX Codec Symmetric	To force the SPA9000 to use a symmetric codec during fax passthrough, select yes. Otherwise, select no. Default: yes
DTMF Process AVT	To use the DTMF process AVT feature, select yes. Otherwise, select no. Default: yes
FAX Passthru Method	Select the fax passthrough method: None, NSE, or ReINVITE. Default: NSE
DTMF Tx Method	Select the method to transmit DTMF signals to the far end: InBand, AVT, INFO, Auto, InBand+INFO, or AVT+INFO. InBand sends DTMF using the audio path. AVT sends DTMF as AVT events. INFO uses the SIP INFO method. Auto uses InBand or AVT based on the outcome of codec negotiation. Default: Auto

DTMF Detection Mode	<p>Determines where to use Normal or Strict DTMF detection</p> <p>Strict mode reduces the likelihood of false DTMF detection but requires an extra hold time after detection. Also the DTMF level is raised. Under strict mode, the minimum duration threshold is 60 and 90 ms for AVT and SIP-INFO respectively. The level threshold is -20 dBm.</p> <p>Default: Strict</p>
FAX Process NSE	<p>To use the fax process NSE feature, select yes. Otherwise, select no.</p> <p>Default: yes</p>
Hook Flash Tx Method	<p>Select the method for signaling hook flash events: None, AVT, or INFO. None does not signal hook flash events. AVT uses RFC2833 AVT (event = 16). INFO uses SIP INFO with the single line signal=hf in the message body. The MIME type for this message body is taken from the Hook Flash MIME Type setting.</p> <p>Default: None</p>
FAX Disable ECAN	<p>If enabled, this feature automatically disables the echo canceller when a fax tone is detected. To use this feature, select yes. Otherwise, select no.</p> <p>Default: no</p>
Release Unused Codec	<p>This feature allows the release of codecs not used after codec negotiation on the first call, so that other codecs can be used for the second line. To use this feature, select yes. Otherwise, select no.</p> <p>Default: yes</p>
FAX Enable T38	<p>To enable the use of the ITU-T T.38 standard for faxing, select yes. Otherwise, select no.</p> <p>Default: yes</p>
FAX Tone Detect Mode	<p>This parameter has three possible values:</p> <p>caller or callee - SPA will detect FAX tone whether it is callee or caller</p> <p>caller only - SPA will detect FAX tone only if it is the caller</p> <p>callee only - SPA will detect FAX tone only if it is the callee</p> <p>Default: caller or callee</p>
FAX T38 Redundancy	<p>The redundancy factor for the T.38 Fax Relay from 0 (none) to 4</p> <p>Default: 1</p>

FAX Tone Detect Mode:	The method of fax tone detection: caller and callee, caller only, or callee only Default: caller or callee NOTE This setting allows a fax tone to be detected from either side of the call.
-----------------------	---

Voice tab > FXS 1/2 page

FXS Port Polarity Configuration section

Idle Polarity	Polarity before a call is connected: Forward or Reverse . Default: Forward
Caller Conn Polarity	Polarity after an outbound call is connected: Forward or Reverse . Default: Forward
Callee Conn Polarity	Polarity after an inbound call is connected: Forward or Reverse . Default: Forward

Voice tab >

Line 1/2/3/4 page

You can use the *Line 1 - Line 4* pages to configure the line interfaces on your SPA9000. The line interface page includes the following sections:

- “Line Enable section,” on page 252
- “Network Settings section,” on page 252
- “SIP Settings section,” on page 252
- “Subscriber Information section,” on page 255
- “Dial Plan section,” on page 256
- “NAT Settings section,” on page 256
- “Proxy and Registration section,” on page 257

Voice tab > Line page

Line Enable section

Line Enable	To enable this line for service, select yes. Otherwise, select no. Default: yes
-------------	---

Voice tab > Line page

Network Settings section

SIP ToS/DiffServ Value	TOS/DiffServ field value in UDP IP packets carrying a SIP message. Default: 0x68
SIP CoS Value [0-7]	CoS value for SIP messages. Default: 3
RTP ToS/DiffServ Value	ToS/DiffServ field value in UDP IP packets carrying RTP data. Default: 0xb8
RTP CoS Value [0-7]	CoS value for RTP data. Default: 6

Voice tab > Line page

SIP Settings section

SIP Transport	Options: UDP, TCP, or TLS Default: UDP
SIP Port	Port number of the SIP message listening and transmission port. Default: 5060
SIP 100REL Enable	To enable the support of 100REL SIP extension for reliable transmission of provisional responses (18x) and use of PRACK requests, select yes. Otherwise, select no. Default: no

Auth Resync-Reboot	<p>If this feature is enabled, the SPA9000 authenticates the sender when it receives the NOTIFY resync reboot (RFC 2617) message. To use this feature, select yes. Otherwise, select no.</p> <p>Default: yes</p>
SIP Proxy-Require	<p>The SIP proxy can support a specific extension or behavior when it detects this header from the user agent. If this field is configured and the proxy does not support it, it responds with the message, unsupported. Enter the appropriate header in the field provided.</p> <p>Default: blank</p>
SIP Remote-Party-ID	<p>To use the Remote-Party-ID header instead of the From header, select yes. Otherwise, select no.</p> <p>Default: yes</p>
SIP GUID	<p>The Global Unique ID is generated for each line for each device. When it is enabled, the SPA9000 adds a GUID header in the SIP request. The GUID is generated the first time the unit boots up and stays with the unit through rebooting and even factory reset. This feature was requested by Bell Canada (Nortel) to limit the registration of SIP accounts.</p> <p>Default: no</p>

SIP Debug Option	<p>SIP messages are received at or sent from the proxy listen port. This feature controls which SIP messages to log. Choices are as follows:</p> <p>none—No logging.</p> <p>1-line—Logs the start-line only for all messages.</p> <p>1-line excl. OPT—Logs the start-line only for all messages except OPTIONS requests/responses.</p> <p>1-line excl. NTFY—Logs the start-line only for all messages except NOTIFY requests/responses.</p> <p>1-line excl. REG—Logs the start-line only for all messages except REGISTER requests/responses.</p> <p>1-line excl. OPTINTFYIREG—Logs the start-line only for all messages except OPTIONS, NOTIFY, and REGISTER requests/responses.</p> <p>full—Logs all SIP messages in verbose mode.</p> <p>full excl. OPT—Logs all SIP messages in full text except OPTIONS requests/responses.</p> <p>full excl. NTFY—Logs all SIP messages in full text except NOTIFY requests/responses.</p> <p>full excl. REG—Logs all SIP messages in full text except REGISTER requests/responses.</p> <p>full excl. OPTINTFYIREG—Logs all SIP messages in full text except for OPTIONS, NOTIFY, and REGISTER requests/responses.</p> <p>Default: None</p>
Restrict Source IP	<p>If line interfaces use the same SIP Port value and the Restrict Source IP feature is enabled, the proxy IP address for Lines 1 and 2 is treated as an acceptable IP address for both lines. To enable the Restrict Source IP feature, select yes. Otherwise, select no. A source IP address is untrusted if it does not match any of the IP addresses resolved from the configured <Proxy> (or <Outbound Proxy> if <Use Outbound Proxy> is yes).</p> <p>Default: no</p>
Referor Bye Delay	<p>Controls when the SPA9000 sends BYE to terminate stale call legs upon completion of call transfers. Multiple delay settings (Referor, Refer Target, Referee, and Refer-To Target) are configured on this screen. For the Referor Bye Delay, enter the appropriate period of time in seconds.</p> <p>Default: 4</p>

Refer Target Bye Delay	For the Refer Target Bye Delay, enter the appropriate period of time in seconds. Default: 0
Referee Bye Delay	For the Referee Bye Delay, enter the appropriate period of time in seconds. Default: 0
Refer-To Target Contact	To contact the refer-to target, select yes. Otherwise, select no. Default: no
Auth INVITE	When enabled, authorization is required for initial incoming INVITE requests from the SIP proxy.

Voice tab > Line page

Subscriber Information section

Display Name	Display name for caller ID.
User ID	User ID assigned by the ITSP, often the same as the DID.
Password	Password for this User ID.
Use Auth ID	To use the authentication ID and password for SIP authentication, select yes. Otherwise, select no to use the user ID and password. Default: no
Auth ID	Authentication ID for SIP authentication.
Call Capacity	Maximum number of calls allowed on this line interface. You can set a value from 1 to 15, or leave the setting as unlimited. Note that the SPA9000 does not distinguish between incoming and outgoing calls when talking about call capacity. NOTE Unlimited = 16. Default: unlimited
Contact List	List of client stations that the SPA9000 alerts when there is an incoming call to the line interface from the ITSP.
Cfwd No Ans Delay	Delay, in seconds, before the call forwarding of no-answer calls feature is triggered. Default: 20

*Voice tab > Line page***Dial Plan section**

Dial Plan	Dial plan script for this line. Default: (xx.) The Dial Plan strips off the steering digit prior to sending the dialed number to the ITSP.
-----------	--

*Voice tab > Line page***NAT Settings section**

NAT Mapping Enable	To use externally mapped IP addresses and SIP/RTP ports in SIP messages, select yes. Otherwise, select no. Default: no
NAT Keep Alive Enable	To send the configured NAT keep alive message periodically, select yes. Otherwise, select no. Default: no
NAT Keep Alive Msg	Enter the keep alive message that should be sent periodically to maintain the current NAT mapping. If the value is \$NOTIFY, a NOTIFY message is sent. If the value is \$REGISTER, a REGISTER message without contact is sent. Default: \$NOTIFY
NAT Keep Alive Dest	Destination that should receive NAT keep alive messages. If the value is \$PROXY, the messages are sent to the current or outbound proxy. Default: \$PROXY
EXT SIP Port	Enter the port number of the external port to substitute for the actual SIP port of the SPA9000 in all outgoing SIP messages. Default: blank

Voice tab > Line page

Proxy and Registration section

Proxy	SIP proxy server for all outbound requests. Default: blank
Outbound Proxy	SIP Outbound Proxy Server where all outbound requests are sent as the first hop.
Use Outbound Proxy	Enable the use of <Outbound Proxy>. If set to no, <Outbound Proxy> and <Use OB Proxy in Dialog) is ignored. Default: no
Use OB Proxy In Dialog	Whether to force SIP requests to be sent to the outbound proxy within a dialog. Ignored if <Use Outbound Proxy> is no or <Outbound Proxy> is empty. Default: yes
Register	Enable periodic registration with the <Proxy>. This parameter is ignored if <Proxy> is not specified. Default: yes
Make Call Without Reg	Allow making outbound calls without successful (dynamic) registration by the unit. If No, dial tone will not play unless registration is successful. Default: no
Register Expires	Allow answering inbound calls without successful (dynamic) registration by the unit. If proxy responded to REGISTER with a smaller Expires value, the SPA9000 will renew registration based on this smaller value instead of the configured value. If registration failed with an Expires too brief error response, the SPA9000 will retry with the value given in the Min-Expires header in the error response. Default: 3600 Recommended: 60
Ans Call Without Reg	Expires value in sec in a REGISTER request. SPA9000 will periodically renew registration shortly before the current registration expired. This parameter is ignored if <Register> is no. Values are yes or no.
Use DNS SRV	Whether to use DNS SRV lookup for Proxy and Outbound Proxy. Default: no

DNS SRV Auto Prefix	<p>If enabled, the SPA9000 will automatically prepend the Proxy or Outbound Proxy name with <code>_sip_udp</code> when performing a DNS SRV lookup on that name.</p> <p>Default: no</p>
Proxy Fallback Intvl	<p>This parameter sets the delay (sec) after which the SPA9000 will retry from the highest priority proxy (or outbound proxy) servers after it has failed over to a lower priority server. This parameter is useful only if the primary and backup proxy server list is provided to the SPA9000 via DNS SRV record lookup on the server name. (Using multiple DNS A record per server name does not allow the notion of priority and so all hosts are considered at the same priority and the SPA9000 will not attempt to fall back after a fail over).</p> <p>Default: 3600</p>
Proxy Redundancy Method	<p>SPA9000 will make an internal list of proxies returned in DNS SRV records. In normal mode, this list will contain proxies ranked by weight and priority.</p> <p>If based on SRV, the port is configured, the SPA9000 does normal first and also inspects the port number based on 1st proxy's port in the list.</p> <p>Default: Normal</p>
Mailbox Status	<p>The status of the connection to the voice mail server</p> <p>Mailbox status for all the mailboxes associated with this line interface. The status is automatically updated when the SPA9000 receives voicemail status notification from the ITSP.</p> <p>Format: [<i>mbs</i>[,<i>mbs</i>[,<i>mbs</i>[,...]]]] where:</p> <p><i>mbs</i> = <i>mbid.new/old</i></p> <p><i>mbid</i> = mailbox ID, such as 12345</p> <p><i>new</i> = number of new messages in mailbox: 0,1,2,...</p> <p><i>old</i> = number of old messages in mailbox: 0, 1, 2, ...</p>
Mailbox Subscribe URL	<p>This parameter allows \$USER and \$PROXY macros, such as \$USER@\$PROXY</p>
Mailbox Deposit URL	<p>This parameter allows \$USER, \$PROXY, and \$MBID macros, such as \$USER@\$PROXY, or \$MBID@\$PROXY.</p> <p>Default: blank</p>
Mailbox Subscribe Expires	<p>Identifies when the mailbox subscription expires.</p> <p>Recommended: 30</p>

Mailbox Manage URL	<p>This parameter allows \$USER, \$PROXY, and \$MBID macros, such as \$USER@\$PROXY, or \$MBID@\$PROXY.</p> <p>Default: blank</p>
VMSP Bridge	<p>Applies only if this line interface offers voice mail services. It specifies whether the SPA9000 should bridge the call from an external caller on the same or a different line interface. The choices are:</p> <p>None—Do not bridge external calls from any line interfaces</p> <p>All—Bridge external calls from any line interfaces except from the same line</p> <p>All+Self—Bridge external calls from any line interfaces including the same line</p> <p>NOTE:</p> <p>If the external call is also on this line interface, the SPA9000 does not attempt to bridge the call even if the value is All.</p> <p>If <PBX Network Interface> is WAN, <Force Media Proxy> must be yes for VMSP Bridging to function properly.</p> <p>Default: None</p>
CFWD Bridge Mode	<p>Instructs the SPA9000 how to handle call forwarding of an external caller to another external number by a client station.</p> <p>The normal way of performing this operation is for the SPA9000 to send a (blind) SIP REFER to the calling device to let it contact the target number directly. It then drops out of the call completely. This requires the calling device to understand the SIP signaling involved and the operation permitted by the underlying service provider. The SPA400, for instance, cannot handle this operation.</p> <p>With bridging, the SPA9000 maintains two separate call legs throughout the call: one with the caller and one with the call forward target. The two call peers connect only with the SPA9000, while the SPA9000 acts as a proxy for the RTP packets exchanged between the two parties.</p> <p>This parameter has two possible values:</p> <p>None—Do not bridge forwarded calls (use the normal REFER method)</p> <p>All—Bridge all forwarded calls</p> <p>Default: None</p>

XFER Bridge Mode	<p>Instructs the SPA9000 how to handle call transferring of an external caller to another external number by a client station.</p> <p>The normal way of performing this operation is for the SPA9000 to send a SIP REFER method to the calling device to let it contact the transfer target directly. The SPA9000 then drops out of the call completely. This requires the calling device (the transferee) and the target device to understand the SIP signaling involved and the operation permitted by the underlying service providers. Note that the call legs with transferee and the transfer target might be with different ITSP. The SPA400, for instance, cannot handle this operation.</p> <p>With bridging, the SPA9000 maintains two separate call legs throughout the call: one with the transferred call and one with the transfer target. The two call peers connect only with the SPA9000, while the SPA9000 acts as a proxy for the RTP packets exchanged between the two parties.</p> <p>This parameter has three possible values:</p> <p>none —Do not bridge call transfer (use the normal REFER method)</p> <p>all —Bridge all call transfer</p> <p>all except same line—Bridge call transfer only if it is between 2 different Line interfaces</p>
------------------	---



SPA400 Field Reference

This appendix describes the fields on each page of the SPA400 administration web server.

- “Setup,” on page 261
- “Administration,” on page 270
- “Status,” on page 272
- “Event Logs,” on page 273

Setup

This section describes the fields on the following pages within the Setup module:

- “Basic Setup,” on page 262
- “SPA9000 Interface,” on page 262
- “Voice,” on page 264
- “Voicemail Server,” on page 268
- “Voicemail Users,” on page 269

Setup tab>

Basic Setup

Network Setup	
Dynamic IP Address (DHCP Client)	Select this button to obtain an IP address through DHCP. Fixed IP address is the recommended setting. Default setting: Dynamic IP Address
Fixed IP Address	Select this button to assign a static IP address to the SPA400. This is the recommended configuration.
IP Subnet Mask	Subnet mask
Gateway IP Address	IP address of the Gateway/Router
Domain Name Server (DNS) Address	
Primary DNS	IP address of the primary domain name server
Secondary DNS	IP address of the secondary domain name server
NTP	
NTP Server 1	IP address or FQDN of a NTP server
Time Zone	Select the time zone
Syslog Server	The IP address of the syslog server to which the SPA9000 sends syslog messages. Leave blank if you do not want to receive syslog messages.

Setup tab>

SPA9000 Interface

SPA9000 User ID	
User ID	The User ID of the SPA9000 This value must be identical to the User ID that is entered on the SPA9000 line interface page for this SPA400 device.

SPA 9000 Address	
Discover Automatically	Select this radio button if you want the SPA400 to learn the SPA9000 IP address and port number from the SIP registration packet. (Recommended)
Static Address	Select this radio button to enter the IP address of SPA9000. Specify the IP Address and Port in the provided fields.
IP Address	IP address of the SPA9000
Port	UDP port number that the SPA9000 uses to register to the SPA400 Default: 5060
Port ID	
Port ID 1	A unique ID for the Line 1 port, too allow the SPA9000 to identify incoming calls from the PSTN Default: FXO_Port_ID_1
Port ID 2	A unique ID for the Line 2 port, too allow the SPA9000 to identify incoming calls from the PSTN Default: FXO_Port_ID_2
Port ID 3	A unique ID for the Line 3 port, too allow the SPA9000 to identify incoming calls from the PSTN Default: FXO_Port_ID_3
Port ID 4	A unique ID for the Line 4 port, too allow the SPA9000 to identify incoming calls from the PSTN Default: FXO_Port_ID_4
Signaling	
Signaling Port	The UDP port that the SPA400 uses to listen for incoming call setup requests Default: 5060
RTP	
RTP Port	The base UDP port for the block of UDP ports that that the SPA400 uses to send and receive RTP and RTCP packets Default: 10000

IP Tos/DiffServ	
Call Signaling Packets	TOS field in IP header for outgoing SIP packets Default: 68
RTP Packets	TOS field in IP header for outgoing RTP/RTCP packets Default: b8
Session	
Enable Session Timer	Enables the SPA400 to encode the Timer header in all INVITE requests for ringing timeout (checked by default)
Desired Refresh Time	Desired session timer in seconds (0 by default)
Minimum Refresh Time	Minimum value of the session timer in seconds (0 by default)

Setup tab>

Voice



NOTE The default settings should be sufficient in most use cases. These settings should be adjusted only after consultation with a service technician for the telephone company. It is essential that these settings are compatible with those of the Central Office.

Voice Codecs	
Preferred Codecs	
Preferred Codec	The preferred voice codec that SPA400 uses to negotiate with remote VoIP devices to determine the voice codec for a call: G.711U, G.711A, or G.729
Voice Codecs	
Packetization	The packetization time in milliseconds for each codec: G.711U, G.711A, G.729
VAD	Voice Activity Detection (OFF or ON) Default: OFF

Voice Setting	
Calling Timers	
Wait-for-Answer time	<p>The time in seconds that the SPA400 waits for the called party to answer the call before terminating the call automatically</p> <p>The maximum value is 100 seconds.</p> <p>Default: 180</p>
Call Limit	<p>The maximum time that a call can continue before it is terminated automatically</p> <p>Default: 65535</p>
Dialing Parameters	
Tone out on	<p>The duration in milliseconds of each tone in a DTMF sequence</p> <p>Default: 200</p>
Tone out off	<p>The number of milliseconds that elapses between successive digits in a DTMF sequence</p> <p>Default: 200</p>
DTMF power	<p>The power level in 0.1 dBm of the DTMF tones</p> <p>Default: -130</p>
Answer after	<p>The number of rings that occur before the SPA400 answers an incoming call</p> <p>The maximum value is 2 rings. Because the PSTN does not transmit caller ID information until after the first ring, this 2-ring setting is recommended to ensure that caller ID information is available.</p> <p>Default: 2</p>
Dial out wait	<p>The number of milliseconds that elapse after the SPA400 seizes a telephony port and before the SPA400 sends DTMF digits</p> <p>Default: 400</p>
Dial out battery threshold	<p>The minimum voltage level that the SPA400 must detect on a telephony port before seizing a telephony port for an outbound call</p> <p>Default: 20</p>

Line Settings	
Transmit Gain	<p>The gain level that the SPA400 may use to increase or attenuate the power level before transmitting to the telephony port</p> <p>NOTE Change this setting if remote call participants have trouble hearing the users of the SPA9000 Voice System. Make changes in increments of 3 dB; changes of less than 3 dB will not have a perceptible impact.</p> <p>Default: 0</p>
Receive Gain	<p>The gain level that the SPA400 may use to increase or attenuate the power level before receiving on the telephony port</p> <p>NOTE The default Receive Gain settings should be satisfactory in most use cases. Unnecessary changes in Receive Gain can cause problems with echo.</p> <p>Default: 0</p>
Impedance	<p>The impedance of the lines that are connected to SPA400's telephony ports</p> <p>Default: 600 Ohms</p>
Tip/Ring voltage	<p>The tip-to-ring voltage reserved for voice transmission</p> <p>Default: 3.5 Volts</p>
Operational loop current Min	<p>The minimum loop current that maintains an off-hook state. If the loop current drops below this value, the phone enters on hook state.</p> <p>Default: 10 mA</p>
On-Hook speed	<p>The time that the loop current drops to 0mA when the phone enters the on-hook state.</p> <p>Default: Less than 0.5ms</p>
Ring frequency Min	<p>The minimum frequency of a valid ring</p> <p>Default: 10</p>
Ring frequency Max	<p>The maximum frequency of a valid ring</p> <p>Default: 100</p>
Ring Validation Time	<p>The minimum duration of a valid ring</p> <p>Default: 256ms</p>

Ring Indication Delay	The delay in reporting the ring after it presents on the PSTN line Default: 512ms
Ring Timeout	The delay on reporting that the ring stopped after it no longer presents on the PSTN line Default: 640ms
Ring Threshold	The minimum voltage(rms value) of a valid ring Default: 13.5-16.5vrms
Ringer Impedance	Default: High
DC current Limiting	Default: Enable
Caller Id & CP Tone Method	The regional settings for Caller ID and call progress tones Default: North American
Battery reversal as disconnect signal	Can be chosen as a method for signalling the end of a call Default: unselected
Loop period shut-down as disconnect signal	Can be chosen as a method for signalling the end of a call Default: selected
Minimum period for disconnect signal	The minimum duration that the loop current is cut off to signal the end of the call; used with the loop period shut-down method Default: 750
Tear down FXO port when silence detected for	The duration of silence that causes the FXO port to disconnect the call Default: 300

Setup tab>

Voicemail Server

Voicemail Settings	
Server Port	<p>The UDP port this is open to receive packets</p> <p>NOTE This port number must be different from the signaling port on the SPA9000 line interface. This port appears in the various mailbox URL fields on the SPA9000 line interface page.</p> <p>Default: 5090</p>
SPA9000 subscriber ID	<p>The ID that the SPA9000 uses to subscribe to the SPA400 voice mail server to obtain notifications</p> <p>NOTE This value appears in the <i>Proxy and Registration: Mailbox Subscribe URL</i> field on the SPA9000 line interface page.</p> <p>Example</p> <ul style="list-style-type: none"> ▪ SPA9000 subscriber ID: 8888 ▪ Mailbox Subscribe URL: 8888@192.168.0.110:5090 <p>Default: 8888</p>
Mailbox deposit number	<p>The phone number that the SPA9000 uses to deposit voice mail</p> <p>NOTE This value appears in the <i>Proxy and Registration: Mailbox Deposit URL</i> field on the SPA9000 line interface page.</p> <p>Example</p> <ul style="list-style-type: none"> ▪ Mailbox deposit number: 900 ▪ Mailbox Deposit URL: 900@192.168.0.110:5090 <p>Default: 900</p>

Mailbox manage number	<p>The phone number that the SPA9000 uses to access voice mail</p> <p>NOTE This value appears in the <i>Proxy and Registration: Mailbox Manage URL</i> field on the SPA9000 line interface page.</p> <p>Example</p> <ul style="list-style-type: none"> ▪ Mailbox manage number: 800 ▪ Mailbox Manage URL: 800@192.168.0.110:5090 <p>Default: 800</p>
AA Language	<p>The language that is used by the voice mail Auto Attendant: English, German, Spanish, French, Dutch, Portuguese, Czech</p> <p>Default: English</p>
Maximum length of a voicemail message	<p>The maximum number of seconds that can elapse before a voice mail message is ended automatically</p> <p>Default: 60</p>

Setup tab>

Voicemail Users

User Setting	
Enable User <i>N</i>	<p>Enables the mailbox</p> <p>NOTE: Each mailbox can be assigned to a client station that is managed by the SPA9000. Before a station can deposit and access voicemail, the mail box ID must be configured through the <i>Ext N</i> page.</p>
User ID	The mailbox ID
Password	The password for the mailbox

Administration

This section describes the fields on the following pages within the Administration module:

- “Management,” on page 270
- “Factory Default,” on page 270
- “USB Setting,” on page 271
- “Firmware Upgrade,” on page 271
- “Reboot,” on page 271

Administration tab>

Management

Local Access	
Gateway Username	The user name that is entered to log on to the SPA400 web configuration utility (default = Admin)
Gateway Password	The password that is entered to log on to the SPA400 web configuraton utility (default = <i>blank</i>)
Re-enter to Confirm	If you entered a new password, retype it in this field.

Administration tab>

Factory Default

Restore Factory Defaults	Erases the current settings and resets the SPA400 to the original factory default settings
--------------------------	--

Administration tab>

USB Setting

USB status	The status of the USB storage device: mount (file system mounted and available) or unmount
I want to reset USB (check box) Reset (button)	Erases the voice mail messages that are stored on the USB

Administration tab>

Firmware Upgrade

File Path	The file path to the firmware file that you want to install, as selected by using the Browse button
Browse	Allows you to select a firmware file on your PC, and populates the <i>File Path</i> field
Upgrade	Starts the Firmware upgrade, using the file that is specified in the <i>File Path</i> field

Administration tab>

Reboot

Restart System	Restarts the SPA400 NOTE All SPA400 connections will be broken.
----------------	---

Status

The Status page provides information. This page is read only. No changes can be made.

Status tab>

Gateway

Gateway Information	
Firmware Version	The firmware version that is installed on this device
Build Date	The date when the firmware was last updated
MAC Address	The MAC address of this device
Current Time	The current date and time
System Up Time	The length of time that the system has been operating, in days, hours, and minutes
Internet Connection	
IP Address	The IP address of this device
IP Subnet Mask	The subnet mask for this subnet
Gateway IP Address	The IP address of the gateway device
Primary DNS	The primary DNS server
Secondary DNS	The secondary DNS server
SPA400 Status	
USB status	The status of the USB storage device: mount (file system mounted and available) or unmount
Voice mail status	The status of the voice mail service; OK indicates that voice mail service is enabled
USB capacity status	The amount of storage space that is currently in use, and the amount that is remaining, example: Used 5712KB, remaining 119960KB
SIP registration status	The status of the SIP registration; Registered indicates that the SPA9000 is registered to the SPA400

FXO Line status	
Hook Status	
Line status (1-4)	The status of each line port: <ul style="list-style-type: none"> On-Hook indicates that the FXO port is not in use. Off-Hook indicates that a call is in progress.
Battery Level	
Line (1-4)	The currently voltage on the line port, if the port is connected to a PSTN line; for example, a connected line could show -51 V

Event Logs

This section describes the fields on the SetLog Level page.

Event Logs tab>

Set Log Level

SPA400 logs significant events onto its internal buffer. For each log type, you can choose to include Fatal Errors, Errors, Events, or All Information. Another option is OFF, meaning that no information is collected for the selected log type.

Event Log Level	
Telephony	Log level for telephony events
SIP	Log level for SIP events
DSP	Log level for DSP events
Dial plan	Log level for dial plan events
Voice mail	Log level for voice mail events
Others	Log level for all other events

Tone

Call process tone configuration	
Tone on fraction	The duty cycle of the CP tone to be detected
High cutoff frequency	The highest frequency of a valid CP tone
Low cutoff frequency	The lowest frequency of a valid CP tone
Call process tone detection	
Tone Setting	
Detection time	The cadence of the CP tone to be detected; if the tone's cadence matches the time length as in the edit boxes, it is considered a valid CP tone
Repeat	
Repeat count	The number of times that the cadence needs to repeat to be considered as a valid CP tone.

Where to Go From Here

This appendix describes additional resources that are available to help you and your customer obtain the full benefits of the SPA9000 Voice System.

- “Product Resources,” on page 275
- “Related Documentation,” on page 276

Product Resources

Website addresses in this document are listed without **http://** in front of the address because most current web browsers do not require it. If you use an older web browser, you may have to add **http://** in front of the web address.

Resource	Location
Technical Documentation	www.cisco.com/en/US/products/ps10030/tsd_products_support_series_home.html
Firmware Downloads	Go to tools.cisco.com/support/downloads , and enter the model number in the Software Search box.
Cisco Community Central > Small Business Support Community	www.myciscocommunity.com/community/smallbizsupport/voiceandconferencing/voice
Phone Support	www.cisco.com/en/US/support/tsd_cisco_small_business_support_center_contacts.html
Warranty and End-User License Agreement	www.cisco.com/go/warranty

Resource	Location
Open Source License Notices	www.cisco.com/go/osln
Regulatory Compliance and Safety Information	www.cisco.com/en/US/products/ps10030/tsd_products_support_series_home.html
Cisco Partner Central (Login Required)	www.cisco.com/web/partners/sell/smb
Cisco Small Business Home	www.cisco.com/smb

Related Documentation

The following table describes the various documents that Cisco provides to help you to install, configure, and manage the SPA9000 Voice System and its components.

These documents and more are available at the following URL:

www.cisco.com/en/US/products/ps10030/tsd_products_support_series_home.html

Document Title	Description	Intended Audience
<i>SPA9000 Voice System Installation and Configuration Guide Using the Setup Wizard</i>	Installation, configuration and maintenance of the SPA9000 Voice System by using the Setup Wizard.	End Users, VARs, and Service Providers
<i>SPA9000 Voice System Installation and Configuration Guide - Web-UI (Legacy) Based Product Configuration</i>	Manual installation of the SPA9000 Voice System, by using the Web User Interface, instead of the Cisco SPA900 Voice System Setup Wizard.	End Users, VARs, and Service Providers

Document Title	Description	Intended Audience
<i>SPA9000 Voice System Administration Guide</i>	<ul style="list-style-type: none"> ▪ Administration and configuration of system features using the SPA9000 and SPA400 ▪ Deployment options for ITSP, PSTN, and ISDN services ▪ SPA9000, SPA400, SPA900 series phones 	VARs and Service Providers
<i>SPA9x2 Phone Administration Guide</i>	<ul style="list-style-type: none"> ▪ Configuration and management of SPA9x2 series IP phones ▪ Deployment options with or without the SPA9000 IP PBX ▪ SPA9x2 series IP phones 	VARs and Service Providers
<i>SPA9x2 Phone User Guide</i>	<ul style="list-style-type: none"> ▪ Phone setup ▪ Phone features ▪ SPA9x2 series IP phones 	VARs and phone end-users
<i>Analog Telephone Adapter Administration Guide</i>	<ul style="list-style-type: none"> ▪ Administration and use of Cisco Small Business ATAs ▪ PAP2T, SPA2102, SPA3102, SPA8000, WRP400, and WRTP54G 	VARs, system administrators, and Service Providers
User Guide for switch		
User Guide for router		

Glossary

ACD (Automatic Call Distribution)—A switching system designed to allocate incoming calls to certain positions or agents in the order received and to hold calls not ready to be handled (often with a recorded announcement).

Area code—A 3-digit code used in North America to identify a specific geographic telephone location. The first digit can be any number between 2 and 9. The second and third digits can be any number.

Billing increment—The division by which the call is rounded. In the field it is common to see full-minute billing on the local invoice while 6-second rounding is the choice of most long-distance providers that bill their customers directly.

Blocked calls—Caused by an insufficient network facility that does not have enough lines to allow calls to reach a given destination. May also pertain to a call from an originating number that is blocked by the receiving telephone number.

Bundled service—Offering various services as a complete package.

Call completion—The point at which a dialed number is answered.

Call termination—The point at which a call is disconnected.

CDR (Call Detail Records)—A software program attached to a VoIP/telephone system that records information about the telephone number's activity.

Carrier's carrier—Companies that build fiber optic and microwave networks primarily selling to resellers and carriers. Their main focus is on the wholesale and not the retail market.

Casual access—When customers choose not to use their primary carriers to process the long-distance call being made. The customer dials the carrier's 101XXXX number.

CO (Central Office)—Switching center for the local exchange carrier.

Centrex—This service is offered by the LEC to the end user. The feature-rich Centrex line offers the same features and benefits as a PBX to a customer without the capital investment or maintenance charges. The LEC charges a monthly fee to the customer, who must agree to sign a term agreement.

Circuits—The communication path(s) that carry calls between two points on a network.

Customer Premise Equipment—The only part of the telecommunications system that the customer comes into direct contact with. Example of such pieces of equipment are telephones, key systems, PBXs, voice-mail systems, and call accounting systems as well as wiring telephone jacks. The standard for this equipment is set by the FCC, and the equipment is supplied by an interconnect company.

Dedicated access—Customers have direct access to the long-distance provider via a special circuit (T1 or private lines). The circuit is hardwired from the customer site to the POP and does not pass through the LEC switch. The dial tone is provided from the long-distance carrier.

Dedicated Access Line (DAL)—Provided by the local exchange carrier. An access line from the customer's telephone equipment directly to the long-distance company's switch or POP.

Demarcation point—This is where the LEC ownership and responsibility (wiring, equipment) ends and the customer's responsibilities begin.

Direct Inward Dialing (DID)—Allows an incoming call to bypass the attendant and ring directly to an extension. Available on most PBX systems and a feature of Centrex service.

Dual Tone Multifrequency (DTMF)—Better known as the push button keypad. DTMF replaces dial pulses with electronically produced tones for network signaling.

Enhanced service—Services that are provided in addition to basic long distance and accessed by way of a touchtone phone through a series of menus.

Exchange code (NXX)—The first three digits of a phone number.

Flat-rate pricing—The customer is charged one rate (sometimes two rates, one for peak and one for off-peak) rather than a mileage-sensitive program rate.

IXC (Interexchange Carrier)—A long-distance provider that maintains its own switching equipment.

IVR (Interactive Voice Response)—Provides a mechanism for information to be stored and retrieved using voice and a touchtone telephone.

Local loop—The local telephone company provides the transmission facility from the customer to the telephone company's office, which is engineered to carry voice and/or data.

North American Numbering Plan (NANP)—How telephone numbers are identified in North America. The telephone number can be identified based on their three separate components: (NPA), (NXX), and (XXXX).

PIN (Personal Identification Code)—A customer calling/billing code for prepaid and pay-as-you-go calling cards.

Private Branch Exchange—Advanced phone system commonly used by the medium to larger customer. It allows the customer to perform a variety of in-house routing (inside calling). The dial tone that is heard when the customer picks up the phone is an internal dial tone.

SS7 (Signaling Number 7)—Technology used by large carriers to increase the reliability and speed of transmission between switches.

Switch (switching)—Equipment that connects and routes calls and provides other interim functions such as least cost routing, IVR, and voicemail. It performs the “traffic cop” function of telecommunications via automated management decisions.

Touchtone (DTMF)—The tone recognized by a push button (touchtone) telephone.

Unified messaging— Platform that lets users send, receive, and manage all e-mail, voice, and fax messages from any telephone, PC, or information device.

Voicemail—A system that allows storage and retrieval of voice messages through voice-mail boxes.

Acronyms

This appendix defines acronyms that are commonly used in Linksys documentation.

A/D	Analog To Digital Converter
ANC	Anonymous Call
B2BUA	Back to Back User Agent
Bool	Boolean Values. Specified as “yes” and “no”, or “1” and “0” in the profile
CA	Certificate Authority
CAS	CPE Alert Signal
CDR	Call Detail Record
CID	Caller ID
CIDCW	Call Waiting Caller ID
CNG	Comfort Noise Generation
CPC	Calling Party Control
CPE	Customer Premises Equipment
CWCID	Call Waiting Caller ID
CWT	Call Waiting Tone
D/A	Digital to Analog Converter
dB	decibel
dBm	dB with respect to 1 milliwatt

DHCP	Dynamic Host Configuration Protocol
DNS	Domain Name Server
DRAM	Dynamic Random Access Memory
DSL	Digital Subscriber Loop
DSP	Digital Signal Processor
DTAS	Data Terminal Alert Signal (same as CAS)
DTMF	Dual Tone Multiple Frequency
FQDN	Fully Qualified Domain Name
FSK	Frequency Shift Keying
FXS	Foreign eXchange Station
GW	Gateway
ITU	International Telecommunication Union
HTML	Hypertext Markup Language
HTTP	Hypertext Transfer Protocol
HTTPS	HTTP over SSL
ICMP	Internet Control Message Protocol
IGMP	Internet Group Management Protocol
ILEC	Incumbent Local Exchange Carrier
IP	Internet Protocol
ISP	Internet Service Provider
ITSP	IP Telephony Service Provider
IVR	Interactive Voice Response
LAN	Local Area Network
LBR	Low Bit Rate
LBRC	Low Bit Rate Codec

MC	Mini-Certificate
MGCP	Media Gateway Control Protocol
MOH	Music On Hold
MOS	Mean Opinion Score (1-5, the higher the better)
ms	Millisecond
MSA	Music Source Adaptor
MWI	Message Waiting Indication
OSI	Open Switching Interval
PCB	Printed Circuit Board
PR	Polarity Reversal
PS	Provisioning Server
PSQM	Perceptual Speech Quality Measurement (1-5, the lower the better)
PSTN	Public Switched Telephone Network
NAT	Network Address Translation
OOB	Out-of-band
REQT	(SIP) Request Message
RESP	(SIP) Response Message
RSC	(SIP) Response Status Code, such as 404, 302, 600
RTP	Real Time Protocol
RTT	Round Trip Time
SAS	Streaming Audio Server
SDP	Session Description Protocol
SDRAM	Synchronous DRAM
sec	seconds
SIP	Session Initiation Protocol

SLA	Shared line appearance
SLIC	Subscriber Line Interface Circuit
SP	Service Provider
SPA	Linksys Phone Adaptor
SSL	Secure Socket Layer
TFTP	Trivial File Transfer Protocol
TCP	Transmission Control Protocol
UA	User Agent
uC	Micro-controller
UDP	User Datagram Protocol
URL	Uniform Resource Locator
VM	Voicemail
VMWI	Visual Message Waiting Indication/Indicator
VQ	Voice Quality
WAN	Wide Area Network
XML	Extensible Markup Language